

WHITE BIRD GRADE

FOR 60 YEARS AFTER CONSTRUCTION WAS COMPLETED IN 1915, WHITE BIRD GRADE (ACROSS THE VALLEY) SERVED IDAHO'S ONLY NORTH-SOUTH HIGHWAY.

Many tortuous curves and switchbacks-- which, if placed together, made 37 complete circles-- let the old road climb 2900 feet in 14 miles. Gaining an elevation of 4329 at its summit, that route represented a significant engineering and construction achievement. This new grade did not replace it until 1975.

327

IDAHO

C

OMMERCIAL

D

RIVER'S

L

ICENSE

Manual

September 2013 Edition

Published by the



Catalog # 01-970001-2

IDAHO
COMMERCIAL
DRIVER'S LICENSE
MANUAL

Published by
The Idaho Transportation Department
Division of Motor Vehicles
P.O. Box 7129
Boise, Idaho 83707-1129

September 2013 Edition

Manual developed in conjunction with the
American Association of Motor Vehicle Administrator's
2005 CDL Testing Model

This manual and the *Idaho Driver's Manual* must both be studied in preparation for your CDL examinations. Both manuals paraphrase the language of the Idaho Motor Vehicle Code. Courts go by the actual language of the code, not these texts.

The Idaho Transportation Department (ITD) is committed to compliance with Title VI of the Civil Rights Act of 1964 and all related regulations and directives. ITD assures that no person shall on the grounds of race, color, national origin, gender, age, or disability be excluded from participation in, be denied the benefits of, or be otherwise subjected to discrimination under any ITD service, program, or activity. The department also assures that every effort will be made to prevent discrimination through the impacts of its programs, policies, and activities on minority and low-income populations. In addition, the department will take reasonable steps to provide meaningful access to services for persons with limited English proficiency.

TABLE OF CONTENTS

CHAPTER 1 : INTRODUCTION	1-1
1.1 LICENSES AND ENDORSEMENTS.....	1-2
1.1.1 License Classes	1-2
1.1.2 Endorsements	1-2
1.1.3 Restrictions	1-3
1.2 SEASONAL CDL FOR FARM-RELATED SERVICES	1-3
1.2.1 Requirements	1-3
1.3 CDL LICENSE FEES	1-4
1.4 HOW TO GET A CDL	1-4
1.4.1 General Commercial Driver Qualifications:	1-4
1.4.2 Instruction Permits	1-5
1.4.3 CDL tests	1-5
1.4.4 Knowledge Tests	1-5
1.4.5 Skills Test	1-6
1.5 MEDICAL REQUIREMENTS FOR CDL HOLDERS.....	1-6
1.5.1 Qualifications For Drivers	1-6
1.5.2 Medical Card Exemptions For Commercial Driver Qualifications	1-7
1.5.3 Exempt Commodities List- Idaho	1-7
1.5.4 Exempt Operations	1-8
1.6 SELF-CERTIFICATION REQUIREMENTS.....	1-9
1.7 COMPLIANCE SAFETY ACCOUNTABILITY (CSA) INFORMATION.....	1-9
1.8 SAFETY RULES.....	1-10
1.9 CENTRAL ISSUE OF DRIVER'S LICENSES	1-11
1.10 DISQUALIFICATIONS.....	1-12
1.11 ALCOHOL TESTS AND THE LAW (IMPLIED CONSENT)	1-13
1.12 ADMINISTRATIVE LICENSE SUSPENSIONS (ALS)	1-13
1.13 DRUG AND ALCOHOL TESTING	1-14
1.14 DRIVER RECORD REQUESTS.....	1-14
CHAPTER 2 : DRIVING SAFETY	2-1
2.1 VEHICLE INSPECTION.....	2-1
2.1.1 Why Inspect	2-1
2.1.2 Types of Vehicle Inspection	2-1
2.1.3 What to Look For:	2-2
2.1.4 CDL Pre-trip Vehicle Inspection Test:	2-4
2.1.5 Seven-Step Inspection Method:	2-4
2.1.6 Inspection during a Trip	2-12
2.1.7 Post-trip Inspection and Report	2-12
2.2 BASIC CONTROL OF YOUR VEHICLE	2-13
2.2.1 Accelerating	2-13
2.2.2 Steering	2-13
2.2.3 Stopping	2-13
2.2.4 Backing Safely	2-14
2.3 SHIFTING GEARS.....	2-14
2.3.1 Manual Transmissions	2-14
2.3.2 Multi-speed Rear Axles and Auxiliary Transmissions	2-15
2.3.3 Automatic Transmissions	2-15
2.3.4 Retarders (also known as "Jake Brakes")	2-15
2.4 SEEING.....	2-16
2.4.1 Seeing Ahead	2-16
2.4.2 Seeing to the Sides and Rear	2-16
2.5 COMMUNICATING	2-18

2.5.1	<i>Signal Your Intentions</i>	2-18
2.5.2	<i>Communicating Your Presence</i>	2-18
2.6	CONTROLLING SPEED	2-20
2.6.1	<i>Stopping Distance</i>	2-20
2.6.2	<i>Matching Speed to the Road Surface</i>	2-21
2.6.3	<i>Speed and Curves</i>	2-21
2.6.4	<i>Speed and Distance Ahead</i>	2-21
2.6.5	<i>Speed and Traffic Flow</i>	2-22
2.6.6	<i>Speed on Downgrades</i>	2-22
2.6.7	<i>Roadway Work Zones</i>	2-22
2.7	MANAGING SPACE	2-23
2.7.1	<i>Space Ahead</i>	2-23
2.7.2	<i>Space Behind</i>	2-23
2.7.3	<i>Space to the Sides</i>	2-24
2.7.4	<i>Space Overhead</i>	2-24
2.7.5	<i>Space Below</i>	2-24
2.7.6	<i>Space for Turns</i>	2-25
2.7.7	<i>Space Needed to Cross or Enter Traffic</i>	2-26
2.8	SEEING HAZARDS	2-26
2.8.1	<i>Importance of Seeing Hazards</i>	2-26
2.8.2	<i>Hazardous Roads</i>	2-26
2.8.3	<i>Drivers Who May Pose a Hazard</i>	2-27
2.8.4	<i>Always Have a Plan</i>	2-29
2.9	DISTRACTED DRIVING	2-29
2.9.1	<i>Don't Drive Distracted</i>	2-29
2.9.2	<i>In-vehicle Communication Equipment</i>	2-30
2.9.3	<i>Watch Out for Other Distracted Drivers</i>	2-32
2.10	AGGRESSIVE DRIVERS/ROAD RAGE	2-32
2.10.1	<i>What Is It?</i>	2-32
2.10.2	<i>Don't Be an Aggressive Driver</i>	2-32
2.10.3	<i>What You Should Do When Confronted by an Aggressive Driver</i>	2-33
2.11	DRIVING AT NIGHT	2-33
2.11.1	<i>More Dangerous</i>	2-33
2.11.2	<i>Driver Factors</i>	2-33
2.11.3	<i>Roadway Factors</i>	2-33
2.11.4	<i>Vehicle Factors</i>	2-34
2.11.5	<i>Night Driving Procedures</i>	2-34
2.12	DRIVING IN FOG	2-35
2.13	DRIVING IN WINTER	2-35
2.13.1	<i>Vehicle Checks</i>	2-35
2.13.2	<i>Driving</i>	2-36
2.14	DRIVING IN VERY HOT WEATHER	2-37
2.14.1	<i>Vehicle Checks</i>	2-37
2.14.2	<i>Driving</i>	2-37
2.15	RAILROAD-HIGHWAY CROSSINGS	2-38
2.15.1	<i>Types of Crossings</i>	2-38
2.15.2	<i>Warning Signs and Devices</i>	2-38
2.15.3	<i>Driving Procedures</i>	2-39
2.15.4	<i>Stopping Safely at Railroad-Highway Crossings</i>	2-39
2.15.5	<i>Crossing the Tracks</i>	2-40
2.15.6	<i>Special Situations</i>	2-40
2.16	MOUNTAIN DRIVING	2-40
2.16.1	<i>Select a "Safe" Speed</i>	2-40
2.16.2	<i>Select the Right Gear before Starting Down the Grade</i>	2-40
2.16.3	<i>Brake Fading or Failure</i>	2-41
2.16.4	<i>Proper Braking Technique</i>	2-41

2.17 DRIVING EMERGENCIES	2-42
2.17.1 Steering to Avoid a Crash	2-42
2.17.2 How to Stop Quickly and Safely	2-43
2.17.3 Brake Failure	2-44
2.17.4 Tire Failure	2-45
2.18 ANTILOCK BRAKING SYSTEMS (ABS)	2-45
2.18.1 How Antilock Braking Systems Work	2-45
2.18.2 Antilock Braking Systems Required on Newer Vehicles	2-46
2.18.3 How to Know If Your Vehicle Is Equipped with ABS	2-46
2.18.4 How ABS Helps You	2-46
2.18.5 ABS on the Tractor Only or Only on the Trailer	2-47
2.18.6 Braking with ABS	2-47
2.18.7 Braking If ABS Is Not Working	2-47
2.18.8 Safety Reminders	2-47
2.19 SKID CONTROL AND RECOVERY	2-48
2.19.1 Drive-wheel Skids	2-48
2.19.2 Correcting a Drive-wheel Braking Skid	2-48
2.19.3 Front-wheel Skids	2-49
2.20 ACCIDENT PROCEDURES	2-49
2.20.1 Protect the Area	2-49
2.20.2 Notify Authorities	2-49
2.20.3 Care for the Injured	2-49
2.21 FIRES	2-49
2.21.1 Causes of Fire	2-50
2.21.2 Fire Prevention	2-50
2.21.3 Fire Fighting	2-50
2.22 ALCOHOL, OTHER DRUGS, AND DRIVING	2-51
2.22.1 Alcohol and Driving	2-51
2.22.2 Other Drugs	2-53
2.23 STAYING ALERT AND FIT TO DRIVE	2-53
2.23.1 Be Ready to Drive	2-54
2.23.2 While You Are Driving	2-54
2.23.3 When You Do Become Sleepy	2-55
2.23.4 Illness	2-55
2.24 HAZARDOUS MATERIALS RULES FOR ALL COMMERCIAL DRIVERS	2-55
2.24.1 What Are Hazardous Materials?	2-55
2.24.2 Why Are There Rules?	2-55
2.24.3 Lists of Regulated Products	2-56
2.25 SHARING THE ROAD	2-57
2.25.1 Introduction	2-57
2.25.2 Motorcycles	2-58
2.25.3 Bicyclists	2-58
2.25.4 Pedestrians	2-60
2.25.5 Children at Play	2-60
2.25.6 Horseback Riders	2-61
2.25.7 Funeral Processions	2-61
2.25.8 Open Range	2-61
2.26 IDAHO PORT OF ENTRY INFORMATION	2-61
2.26.1 Port Of Entry:	2-61
2.26.2 Gross Weight	2-61
2.26.3 Maximum Gross Weight	2-62
2.26.4 Who Must Stop:	2-62
2.26.5 Size Limitations	2-62
2.26.6 Weight Limits:	2-62
2.26.5 Size Limitations	2-62
CHAPTER 3 : TRANSPORTING CARGO SAFELY	3-1

3.1 INSPECTING CARGO	3-1
3.2 WEIGHT AND BALANCE	3-1
3.2.1 Definitions You Should Know	3-1
3.2.2 Legal Weight Limits	3-2
3.2.3 Don't Be Top-heavy	3-2
3.2.4 Balance the Weight	3-2
3.3 SECURING CARGO	3-2
3.3.1 Blocking and Bracing	3-2
3.3.2 Cargo Tie-down	3-3
3.3.3 Header Boards	3-3
3.3.4 Covering Cargo	3-3
3.3.5 Sealed and Containerized Loads	3-4
3.4 CARGO NEEDING SPECIAL ATTENTION	3-4
3.4.1 Dry Bulk	3-4
3.4.2 Hanging Meat	3-4
3.4.3 Livestock	3-4
3.4.4 Oversized Loads	3-4
CHAPTER 4 : TRANSPORTING PASSENGERS SAFELY	4-1
4.1 VEHICLE INSPECTION	4-1
4.1.1 Vehicle Systems	4-1
4.1.2 Access Doors and Panels	4-1
4.1.3 Bus Interior	4-1
4.1.4 Roof Hatches	4-2
4.1.5 Use Your Seatbelt!	4-2
4.2 LOADING AND TRIP START	4-2
4.2.1 Hazardous Materials	4-2
4.2.2 Forbidden Hazardous Materials	4-2
4.2.3 Standee Line	4-3
4.2.4 At Your Destination	4-3
4.3 ON THE ROAD	4-3
4.3.1 Passenger Supervision	4-3
4.3.2 Stops	4-3
4.3.3 Common Accidents	4-3
4.3.4 Speed on Curves	4-3
4.3.5 Railroad-highway Crossings	4-4
4.3.6 Drawbridges	4-4
4.4 POST-TRIP VEHICLE INSPECTION	4-4
4.5 PROHIBITED PRACTICES	4-4
4.6 USE OF BRAKE-DOOR INTERLOCKS.....	4-4
CHAPTER 5 : AIR BRAKES	5-1
5.1 THE PARTS OF AN AIR BRAKE SYSTEM	5-1
5.1.1 Air Compressor	5-1
5.1.2 Air Compressor Governor	5-1
5.1.3 Air Storage Tanks	5-1
5.1.4 Air Tank Drains	5-1
5.1.5 Alcohol Evaporator	5-2
5.1.6 Safety Valve	5-2
5.1.7 The Brake Pedal	5-2
5.1.8 Foundation Brakes	5-2
5.1.9 Supply Pressure Gauges	5-4
5.1.10 Application Pressure Gauge	5-4
5.1.11 Low Air Pressure Warning	5-4
5.1.12 Stop Light Switch	5-5
5.1.13 Front Brake Limiting Valve	5-5

5.1.14	<i>Spring Brakes</i>	5-5
5.1.15	<i>Parking Brake Controls</i>	5-5
5.1.16	<i>Antilock Braking Systems (ABS)</i>	5-7
5.2	DUAL AIR BRAKE	5-7
5.3	INSPECTING AIR BRAKE SYSTEMS	5-8
5.3.1	<i>During Step 2: Engine Compartment Checks</i>	5-8
5.3.2	<i>During Step 5: Walk-around Inspection</i>	5-8
5.3.3	<i>During Step 7: Final Air Brake Check</i>	5-10
5.4	USING AIR BRAKES.....	5-11
5.4.1	<i>Normal Stops</i>	5-11
5.4.2	<i>Braking with Antilock Brakes</i>	5-11
5.4.3	<i>Emergency Stops</i>	5-12
5.4.4	<i>Stopping Distance</i>	5-12
5.4.5	<i>Brake Fading or Failure</i>	5-13
5.4.6	<i>Proper Braking Technique</i>	5-13
5.4.7	<i>Low Air Pressure</i>	5-14
5.4.8	<i>Parking Brakes</i>	5-14
CHAPTER 6 : COMBINATION VEHICLES		6-1
6.1	DRIVING COMBINATION VEHICLES SAFELY	6-1
6.1.1	<i>Rollover Risks</i>	6-1
6.1.2	<i>Steer Gently</i>	6-1
6.1.3	<i>Brake Early</i>	6-2
6.1.4	<i>Railroad-highway Crossings</i>	6-2
6.1.5	<i>Prevent Trailer Skids</i>	6-2
6.1.6	<i>Turn Wide For Off-Tracking</i>	6-3
6.1.7	<i>Backing with a Trailer</i>	6-6
6.2	COMBINATION VEHICLE AIR BRAKES.....	6-7
6.2.1	<i>Trailer Hand Valve</i>	6-7
6.2.2	<i>Tractor Protection Valve</i>	6-8
6.2.3	<i>Trailer Air Supply Control</i>	6-8
6.2.4	<i>Trailer Air Lines</i>	6-8
6.2.5	<i>Hose Couplers (Glad Hands)</i>	6-8
6.2.6	<i>Trailer Air Tanks</i>	6-9
6.2.7	<i>Shut-off Valves</i>	6-9
6.2.8	<i>Trailer Service, Parking, and Emergency Brakes</i>	6-9
6.3	ANTILOCK BRAKE SYSTEMS	6-10
6.3.1	<i>Trailers Required to Have ABS</i>	6-10
6.3.2	<i>Braking with ABS</i>	6-10
6.4	COUPLING AND UNCOUPLING	6-11
6.4.1	<i>Coupling Tractor-Semitrailers</i>	6-11
6.4.2	<i>Uncoupling Tractor-Semitrailers</i>	6-14
6.5	INSPECTING A COMBINATION VEHICLE.....	6-16
6.5.1	<i>Additional Things to Check During a Walk-Around Inspection</i>	6-16
6.5.2	<i>Combination Vehicle Brake Check</i>	6-17
CHAPTER 7 : DOUBLES AND TRIPLES		7-1
7.1	PULLING DOUBLE/TRIPLE TRAILERS	7-1
7.1.1	<i>Prevent Trailer from Rolling Over</i>	7-1
7.1.2	<i>Beware of the Crack-the-Whip Effect</i>	7-1
7.1.3	<i>Inspect Completely</i>	7-1
7.1.4	<i>Look Far Ahead</i>	7-1
7.1.5	<i>Manage Space</i>	7-1
7.1.6	<i>Adverse Conditions</i>	7-2
7.1.7	<i>Parking the Vehicle</i>	7-2
7.1.8	<i>Antilock Braking Systems on Converter Dollies</i>	7-2

7.2	COUPLING AND UNCOUPLING	7-2
7.2.1	<i>Coupling Twin Trailers</i>	7-2
7.2.2	<i>Uncoupling Twin Trailers</i>	7-5
7.2.3	<i>Coupling and Uncoupling Triple Trailers</i>	7-5
7.2.4	<i>Coupling & Uncoupling Other Combinations</i>	7-5
7.3	INSPECTING DOUBLES AND TRIPLES.....	7-6
7.3.1	<i>Additional Checks</i>	7-6
7.3.2	<i>Additional Things to Check During a Walk-Around Inspection</i>	7-7
7.4	DOUBLES/TRIPLES AIR BRAKE CHECK	7-7
7.4.1	<i>Additional Air Brake Checks</i>	7-7
7.5	LONG COMMERCIAL VEHICLE (LCV) CERTIFICATION	7-7
CHAPTER 8 : TANK VEHICLES.....		8-1
8.1	INSPECTING TANK VEHICLES	8-1
8.1.1	<i>Leaks</i>	8-1
8.1.2	<i>Check Special Purpose Equipment</i>	8-1
8.1.3	<i>Special Equipment</i>	8-1
8.2	DRIVING TANK VEHICLES	8-1
8.2.1	<i>High Center of Gravity</i>	8-2
8.2.2	<i>Danger of Surge</i>	8-2
8.2.3	<i>Bulkheads</i>	8-2
8.2.4	<i>Baffled Tanks</i>	8-2
8.2.5	<i>Un-baffled Tanks</i>	8-3
8.2.6	<i>Outage</i>	8-3
8.2.7	<i>How Much to Load?</i>	8-3
8.3	SAFE DRIVING RULES	8-3
8.3.1	<i>Drive Smoothly</i>	8-3
8.3.2	<i>Controlling Surge</i>	8-3
8.3.3	<i>Curves</i>	8-4
8.3.4	<i>Stopping Distance</i>	8-4
8.3.5	<i>Skids</i>	8-4
CHAPTER 9 : HAZARDOUS MATERIALS.....		9-1
9.1	THE INTENT OF THE REGULATIONS	
9.1.1	<i>Contain the Material</i>	9-2
9.1.2	<i>Communicate the Risk</i>	9-2
9.1.3	<i>Assure Safe Drivers and Equipment</i>	9-2
9.2	HAZARDOUS MATERIALS TRANSPORTATION: WHO DOES WHAT?	
9.2.1	<i>The Shipper</i>	9-3
9.2.2	<i>The Carrier</i>	9-3
9.2.3	<i>The Driver</i>	9-3
9.3	COMMUNICATION RULES	9-3
9.3.1	<i>Definitions</i>	9-3
9.3.2	<i>Package Labels</i>	9-4
9.3.3	<i>Lists of Regulated Products</i>	9-5
9.3.4	<i>The Shipping Paper</i>	9-7
9.3.5	<i>The Item Description</i>	9-8
9.3.6	<i>Shipper's Certification</i>	9-9
9.3.7	<i>Package Markings and Labels</i>	9-9
9.3.8	<i>Recognizing Hazardous Materials</i>	9-9
9.3.9	<i>Hazardous Waste Manifest</i>	9-9
9.3.10	<i>Placarding</i>	9-10
9.3.11	<i>Placard Tables</i>	9-10
9.4	LOADING AND UNLOADING	9-12
9.4.1	<i>General Loading Requirements</i>	9-12
9.5	BULK PACKAGING MARKING, LOADING AND UNLOADING	9-15

9.5.1	Markings.....	9-15
9.5.2	Tank Loading	9-15
9.5.3	Flammable Liquids	9-15
9.5.4	Compressed Gas.....	9-16
9.6	HAZARDOUS MATERIALS DRIVING AND PARKING RULES	9-16
9.6.1	Parking with Division 1.1, 1.2, or 1.3 Explosives.....	9-16
9.6.2	Parking a Placarded Vehicle (Not Transporting Explosives).....	9-16
9.6.3	Attending Parked Vehicles	9-16
9.6.4	No Flares!.....	9-17
9.6.5	Route Restrictions	9-17
9.6.6	No Smoking.....	9-17
9.6.7	Refuel with Engine Off	9-17
9.6.8	10 B:C Fire Extinguisher.....	9-17
9.6.9	Check Tires.....	9-17
9.6.10	Where to Keep Shipping Papers and Emergency Response Information.....	9-18
9.6.11	Equipment for Chlorine	9-18
9.6.12	Stop Before Railroad Crossings.....	9-18
.....	9-19
9.7	HAZARDOUS MATERIALS-EMERGENCIES.....	9-19
9.7.1	Emergency Response Guidebook (ERG)	9-19
9.7.2	Crashes/Incidents	9-19
9.7.3	Fires	9-19
9.7.4	Responses to Specific Hazards.....	9-20
9.7.5	Required Notification	9-21
9.8	HAZARDOUS MATERIALS GLOSSARY.....	9-23
9.9	HAZARDOUS MATERIALS ENDORSEMENT APPLICATION PROCESS	9-25
CHAPTER 10	: SCHOOL BUSES	10-1
10.1	DANGER ZONES AND USE OF MIRRORS	10-1
10.1.1	Danger Zones.....	10-1
10.1.2	Correct Mirror Adjustment.....	10-1
10.1.3	Outside Left and Right Side Flat Mirrors.....	10-1
10.1.4	Outside Left and Right Side Convex Mirrors	10-2
10.1.5	Outside Left and Right Side Crossover Mirrors	10-2
10.1.6	Overhead Inside Rearview Mirror	10-3
10.2	LOADING AND UNLOADING	10-3
10.2.1	Approaching the Stop	10-3
10.2.2	Loading Procedures.....	10-4
10.2.3	Unloading Procedures on the Route.....	10-5
10.2.4	Unloading Procedures at School.....	10-6
10.2.5	Special Dangers of Loading and Unloading	10-7
10.2.6	Pre-trip and Post-trip Inspection	10-7
10.3	EMERGENCY EXIT AND EVACUATION	10-8
10.3.1	Planning for Emergencies.....	10-8
10.3.2	Evacuation Procedures.....	10-8
10.4	RAILROAD-HIGHWAY CROSSINGS	10-9
10.4.1	Types of Crossings	10-9
10.4.2	Warning Signs and Devices	10-10
10.4.3	Recommended Procedures.....	10-10
10.4.4	Special Situations	10-11
10.5	STUDENT MANAGEMENT.....	10-11
10.5.1	Student Behavior Problems When Loading and Unloading	10-11
10.5.2	Handling Serious Problems.....	10-12
10.6	ANTILOCK BRAKING SYSTEMS	10-12
10.6.1	Vehicles Required to Have Antilock Braking Systems	10-12
10.6.2	How ABS Helps You	10-12

10.6.3	<i>Braking with ABS</i>	10-12
10.6.4	<i>Braking if ABS is Not Working</i>	10-12
10.6.5	<i>Safety Reminders</i>	10-13
10.7	SPECIAL SAFETY CONSIDERATIONS	10-13
10.7.1	<i>Strobe Lights</i>	10-13
10.7.2	<i>Driving in High Winds</i>	10-14
10.7.3	<i>Backing</i>	10-14
10.7.4	<i>Tail Swing</i>	10-14
CHAPTER 11	PRE-TRIP INSPECTION TEST	11-1
11.1	UNDER VEHICLE	11-4
11.1.1	<i>Exhaust System</i>	11-4
11.1.2	<i>Drive Shaft</i>	11-4
11.1.3	<i>Frame</i>	11-4
11.1.4	<i>Leaks Under Vehicle</i>	11-5
11.2	LIGHTS/REFLECTORS/REFLECTOR TAPE	11-5
11.2.1	<i>Headlights (High & Low Beam/Dashboard Lighting Indicator)</i>	11-5
11.2.2	<i>Clearance Lights</i>	11-5
11.2.3	<i>Four-Way Emergency Flashers</i>	11-5
11.2.4	<i>Turn Signals (Left and Right)</i>	11-6
SIDE OF VEHICLE/TRAILER(S)		11-6
11.2.5	<i>Marker Lights</i>	11-6
11.2.6	<i>Reflectors and/or Reflector Tape</i>	11-6
REAR OF VEHICLE/TRAILERS		11-6
11.2.7	<i>Clearance/Identification Lights</i>	11-6
11.2.8	<i>Reflectors and/or Reflector Tape</i>	11-7
11.2.9	<i>Four-Way Emergency Flashers</i>	11-7
11.2.10	<i>Turn Signals (Right & Left)</i>	11-7
11.2.11	<i>Brake Lights (Operational)</i>	11-7
11.2.12	<i>Tail Lights</i>	11-7
11.3	ENGINE COMPARTMENT	11-8
11.3.1	<i>Oil Level</i>	11-8
11.3.2	<i>Coolant Level</i>	11-8
11.3.3	<i>Power Steering Fluid</i>	11-8
11.3.4	<i>Hydraulic Brake Fluid</i>	11-8
11.3.5	<i>Air Compressor</i>	11-9
11.3.6	<i>Alternator</i>	11-9
11.3.7	<i>Water Pump</i>	11-9
11.3.8	<i>Engine Leaks and Hoses</i>	11-10
11.3.9	<i>Engine Belts</i>	11-10
11.4	STEERING COMPONENTS	11-11
11.4.1	<i>Steering Box</i>	11-11
11.4.2	<i>Steering Box Hoses</i>	11-11
11.4.3	<i>Steering Linkage</i>	11-11
11.5	SUSPENSION- FRONT AXLE	11-11
11.5.1	<i>Springs</i>	11-11
11.5.2	<i>Spring Mounts</i>	11-12
11.5.3	<i>U-Bolts</i>	11-12
11.5.4	<i>Shock Absorber</i>	11-12
11.6	BRAKE COMPONENTS	11-13
11.6.1	<i>Slack Adjuster and Pushrod</i>	11-13
11.6.2	<i>Brake Chamber</i>	11-14
11.6.3	<i>Brake Hoses/Lines</i>	11-14
11.6.4	<i>Brake Drum or Rotor</i>	11-14
11.6.5	<i>Brake Linings or Pads</i>	11-14
11.6.6	<i>Fluid or Grease on Drums / Linings or Rotors / Pads</i>	11-15

- 11.7 WHEELS & TIRES 11-15
 - 11.7.1 Tires:** **11-15**
 - 11.7.2 Rims:** **11-16**
 - 11.7.3 Lug Nuts:** **11-16**
 - 11.7.4 Hub Oil/Axle Seals:** **11-16**
- 11.8 DRIVER/FUEL AREA 11-17
 - 11.8.1 Driver’s Door:** **11-17**
 - 11.8.2 Mirrors:** **11-17**
 - 11.8.3 Fuel Tank:** **11-17**
 - 11.8.4 Battery/Box:** **11-17**
 - 11.8.5 Catwalk:** **11-18**
 - 11.8.6 Steps:** **11-18**
 - 11.8.7 Truck Header Board:** **11-18**
- 11.9 SUSPENSION: REAR AXLE (TRUCK OR TRAILER) 11-18
 - 11.9.1 Springs:** **11-18**
 - 11.9.2 Air Bags:** **11-19**
 - 11.9.3 Torque Arm:** **11-19**
 - 11.9.4 Spring Mounts:** **11-20**
 - 11.9.5 U-Bolts:** **11-20**
 - 11.9.6 Shock Absorber:** **11-20**
- 11.10 BRAKE COMPONENTS 11-20
 - 11.10.1 Slack Adjuster and Pushrod:** **11-20**
 - 11.10.2 Brake Chamber:** **11-21**
 - 11.10.3 Brake Hoses/Lines:** **11-22**
 - 11.10.4 Brake Drum or Rotor:** **11-22**
 - 11.10.5 Linings or Pads:** **11-22**
 - 11.10.6 Fluid/Grease on** **11-23**
 - Brake Components:** **11-23**
- 11.11 WHEELS/ TIRES (REAR AXLE) 11-23
 - 11.11.1 Tires:** **11-23**
 - 11.11.2 Rims:** **11-24**
 - 11.11.3 Lug Nuts:** **11-24**
 - 11.11.4 Hub Oil Seal:** **11-24**
 - 11.11.5 Spacers or Space:** **11-25**
- 11.12 IN-CAB CHECK 11-25
 - 11.12.1 Safety Belt:** **11-25**
 - 11.12.2 Emergency Equipment:** **11-25**
 - 11.12.3 Mirrors:** **11-26**
 - 11.12.4 Windshield:** **11-26**
- 11.13 ENGINE START 11-27
 - 11.13.1 ABS Dashboard Indicator Light** **11-27**
 - 11.13.2 Oil Pressure Gauge:** **11-27**
 - 11.13.3 Water Temperature Gauge:** **11-28**
 - 11.13.4 Ammeter/Voltmeter Gauge:** **11-28**
 - 11.13.5 Air Gauge(s):** **11-28**
 - 11.13.6 Heater/Defroster:** **11-28**
 - 11.13.8 Windshield Washer:** **11-29**
 - 11.13.9 Horn(s):** **11-29**
 - 11.13.10 In-Dash Lighting Indicators:** **11-29**
- 11.14 BRAKE TEST 11-29
 - 11.14.1 Parking Brake(s):** **11-29**
 - 11.14.3 Air Brake System Check:** **11-31**
 - 11.14.4 Hydraulic Brake Check:** **11-33**
- COUPLING SYSTEM 11-33
- 11.15 FIFTH WHEEL 11-33
 - 11.15.1 Air/Electric Lines:** **11-33**

11.15.2	Fifth Wheel Mounting Bolts:	11-34
11.15.3	Sliding Fifth Wheel Locking Pins:	11-34
11.15.4	Release Arm:	11-34
11.15.5	Trailer Apron:	11-34
11.15.6	Trailer Apron – Fifth Wheel Plate Gap:	11-35
11.15.7	Fifth Wheel Platform (Skid Plate):	11-35
11.15.8	Fifth Wheel Locking Jaws:	11-35
11.15.9	Trailer Kingpin:	11-35
11.16	OTHER COUPLING SYSTEMS	11-36
11.16.1	Air/Electric Lines:	11-36
11.16.2	Coupling/Mounting bolts:	11-36
11.16.3	Locking Mechanism:	11-36
11.16.4	Hitch/Drawbar & Eye:	11-36
11.16.5	Safety Chains/Cables:	11-36
11.16.6	Breakaway Battery Box/Cable:	11-37
11.17	TRAILER COMPONENTS- FRONT	11-37
11.17.1	Air / Electric Lines :	11-37
11.17.2	Header Board (Headache Rack) or Bulkhead:	11-37
11.17.3	Tongue Storage Area:	11-38
11.18	TRAILER SIDE	11-38
11.18.1	Landing Gear:	11-38
11.18.2	Doors/Ties/Lifts:	11-39
11.18.3	Trailer Frame:	11-39
11.18.4	Tandem Release Arm/Locking Pins:	11-39
11.18.5	ABS Warning Light:	11-39
11.19	TRAILER REAR	11-39
11.19.1	Rear Door/Ties/Lifts:	11-39
11.19.2	Mud Flaps (Splash Guards):	11-40
11.20	ADDITIONAL PRE-TRIP INSPECTION ITEMS FOR SCHOOL BUSES	11-41
11.20.1	School Bus Internal Inspection	11-41
11.20.2	Student Mirror:	11-41
11.20.3	Eight-Way Lighting Indicators:	11-41
11.20.4	Stop Arm Mechanism:	11-41
11.20.5	Passenger Entry Door:	11-42
11.20.6	Passenger Entry Stairs:	11-42
11.20.7	Passenger Entry Handrail:	11-42
11.20.8	Emergency Equipment:	11-42
11.20.9	Passenger Seats:	11-43
11.21	EMERGENCY EXITS	11-43
11.21.1	Windows	11-43
11.21.2	Rear/Side Door(s):	11-43
11.21.3	Emergency Roof Hatches:	11-44
11.22	EXTERNAL INSPECTION	11-44
11.22.1	Mirrors:	11-44
11.22.2	Fuel Tank:	11-44
11.22.3	Battery/Box:	11-45
11.22.4	Compartments:	11-45
11.23	UNDER BUS	11-46
11.23.1	Exhaust System:	11-46
11.23.2	Drive Shaft:	11-46
11.23.3	Frame:	11-47
11.24	FRONT & REAR LIGHTS	11-47
11.24.1	Alternating Flashing Amber and Red Lights:	11-47
11.25	ADDITIONAL PRE-TRIP INSPECTION ITEMS FOR COACH/TRANSIT BUSES	11-47
11.25.1	Internal Inspection-Coach Bus	11-47
11.25.2	Passenger Entry Door:	11-47

11.25.3 Passenger Entry Stair:	11-47
11.25.4 Passenger Entry Handrail:	11-48
11.25.5 Passenger Lift:	11-48
11.25.6 Seats:	11-48
11.26 EMERGENCY EXITS	11-48
11.26.1 Windows:	11-48
11.26.2 Doors:	11-49
11.26.3 Hatches:	11-49
11.27 EXTERNAL INSPECTION	11-49
11.27.1 Level/Air Leaks:	11-49
11.27.2 Mirrors:	11-49
11.27.3 Fuel Tank:	11-49
11.27.4 Battery/Box:	11-50
11.27.5 Baggage Compartment/Doors/Baggage:	11-50
11.27.6 Mud flaps (Splash Guards):	11-50
CHAPTER 12 : BASIC CONTROL SKILLS	12-1
12.1 SCORING	12-1
12.2 EXERCISES & COURSE DIMENSIONS	12-2
12.2.1 Straight Line Backing	12-2
12.2.2 Offset Back/Right	12-2
12.2.3 Offset Back/Left	12-2
12.2.4 Parallel Park (Driver Side)	12-2
12.2.5 Parallel Park (Conventional)	12-2
12.2.6 Alley Dock	12-2
CHAPTER 13 : ROAD TEST	13-1
13.1 HOW YOU WILL BE TESTED.....	13-1
13.1.1 Turns:	13-1
13.1.2 Intersections	13-2
13.1.3 Urban/Rural Straight	13-3
13.1.4 Lane Changes	13-3
13.1.5 Freeway/Expressway	13-3
13.1.6 Stop/Start	13-3
13.1.7 Curve	13-4
13.1.8 Railroad Crossing	13-4
13.1.9 Bridge /Overpass/Sign	13-4
13.1.10 Student Discharge (School Bus)	13-5
13.1.11 Clutch Usage (for Manual Transmission)	13-5
13.1.12 Gear Usage (for Manual Transmission)	13-5
13.1.13 Brake Usage	13-5
13.1.14 Lane Usage	13-5
13.1.15 Steering	13-5
13.1.16 Regular Traffic Checks	13-5
13.1.17 Use of Turn Signals	13-5
Step Three: Hydraulic Brake Check:	13-5
13.2 CDL VEHICLE INSPECTION MEMORY AID.....	13-7
13.3 BRAKE TEST PRACTICE CHECKLIST	13-8
13.4 SAMPLE PRE-TRIP INSPECTION FORM.....	13-9

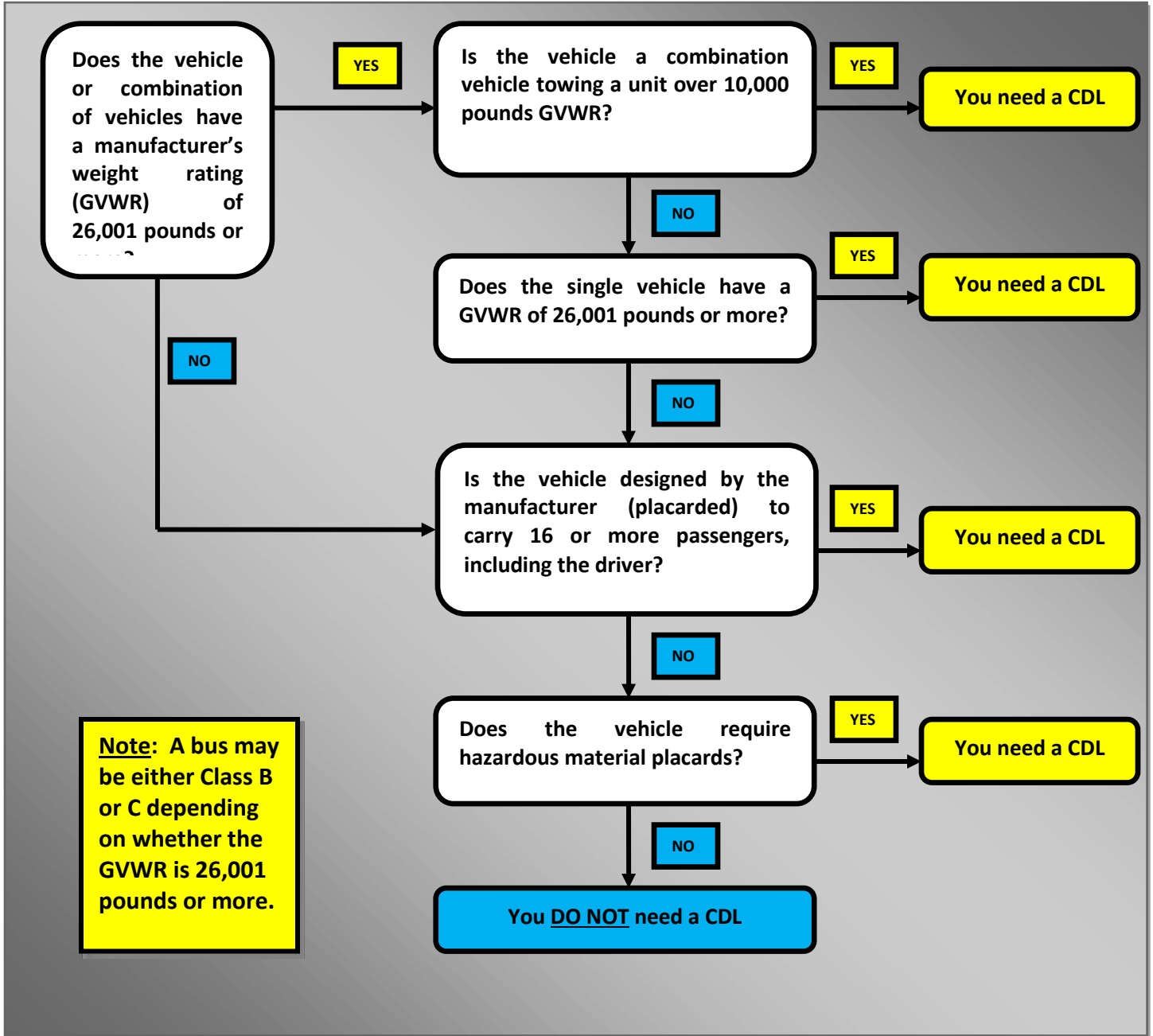

How to Use This Manual

Check the chart below to see what kind of Commercial Driver's License you need.



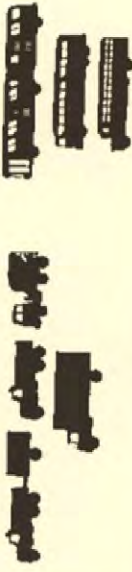

To Obtain License Type	Chapters to Study												
	1	2	3	4	5*	6	7	8	9	10	11	12	13
Class A	X	X	X		X	X					X	X	X
Class B	X	X	X		X						X	X	X
Class C	X	X	X		X						X	X	X
To Obtain Endorsements:													
Hazardous Materials		X	X					X	X				
Double/Triples		X	X		X	X	X						
Tank Vehicle		X	X					X	X				
Passenger		X	X	X							X	X	X
School Bus		X	X							X	X	X	X
*Study Chapter 5 if you plan to operate vehicles equipped with air brakes.													

IDAHO COMMERCIAL DRIVER'S LICENSE CLASSES (FMCSR 383.91) AND ASSOCIATED TESTS





CLASS	VEHICLE DESCRIPTION	TYPICAL VEHICLES IN CLASS	KNOWLEDGE TESTS REQUIRED	SKILLS TESTS REQUIRED
A	Any combination of vehicles with a GCWR of 26,001 or more pounds provided the GVWR of the vehicle(s) being towed is in excess of 10,000 pounds.		<ul style="list-style-type: none"> • General Knowledge • Combination Vehicles • Air Brakes (if equipped) • Endorsement tests as applicable 	<ul style="list-style-type: none"> • Vehicle Inspection • Basic Control Skills • Road Test
B	Any single vehicle with a GVWR of 26,001 or more pounds. Note: These vehicles can tow a vehicle <u>not</u> in excess of 10,000 pounds GVWR.		<ul style="list-style-type: none"> • General Knowledge • Air Brakes (if equipped) • Endorsement tests as applicable 	<ul style="list-style-type: none"> • Vehicle Inspection • Basic Control Skills • Road Test
C	Any single vehicle with a GVWR of 26,000 pounds or less that is hauling placarded hazardous materials or designed to transport 16 or more passengers, including the driver. Note: These vehicles can tow a vehicle <u>not</u> in excess of 10,000 pounds GVWR.		<ul style="list-style-type: none"> • General Knowledge • Air Brakes (if equipped) • Endorsement tests as applicable 	<ul style="list-style-type: none"> • Vehicle Inspection • Basic Control Skills • Road Test

ENDORSEMENTS

T	Combination vehicles with double or triple trailers.		<ul style="list-style-type: none"> • Doubles/Triple Trailers 	Skills tests applicable to class of vehicle brought in for testing.
N	Vehicles used to haul liquids or gaseous materials in permanent tanks or in portable tanks having a rating capacity of 1,000 gallons or more.		<ul style="list-style-type: none"> • Tank Vehicles 	
H	Any vehicle used to transport hazardous materials in placardable amounts.		<ul style="list-style-type: none"> • Hazardous Materials 	Note: Any applicant for a passenger and/or school bus endorsement must take a skills test in a passenger vehicle and/or school bus.
P	Any vehicle designed to transport 16 or more passengers, including the driver.		<ul style="list-style-type: none"> • Passenger Vehicles 	
S	Any vehicle used to transport preprimary, primary or secondary school students from home to school, from school to home, or to and from school-sponsored events		<ul style="list-style-type: none"> • School Bus 	
X	Combination endorsement, representing the hazardous materials and tank vehicles endorsements.		<ul style="list-style-type: none"> • Tank Vehicles • Hazardous Materials 	

Chapter 1 : Introduction

This Chapter Covers:

-  Licenses and Endorsements
-  Fees
-  How to Get a CDL
-  CDL Tests
-  Safety Rules

Idaho's Commercial Driver's License (CDL) Program is designed to improve safety on our highways by meeting federal requirements for testing and licensing commercial drivers. On October 26, 1986, Congress passed the Commercial Motor Vehicle Safety Act of 1986. This law sets minimum standards for the licensing of drivers of commercial motor vehicles. The standards require commercial motor vehicle drivers to get a Commercial Driver's License (CDL). **You must have a CDL to operate any of the following commercial vehicles:**

- Combination vehicle with a gross combination weight rating (GCWR) of 26,001 or more pounds, provided that the gross vehicle weight rating (GVWR) of the towed unit is greater than 10,000 pounds.
- Single vehicle with a gross vehicle weight rating of 26,001 or more pounds.
- Vehicle designed to transport 16 or more persons (including the driver).
- Any size vehicle that requires hazardous material placards.

NOTE: The definition of commercial vehicles includes many heavy duty pickup trucks towing larger trailers, for example. GVWR should be closely checked to determine if the vehicle combination requires a CDL.

Vehicles weighing over 10,000 pounds GVWR used in commerce across state lines fall under Federal Motor Carrier requirements even though the driver may not need a CDL. Operators of vehicles in this Category should contact Idaho State Police, Commercial Vehicle Safety at (208) 884-7220 for guidance.

GROSS VEHICLE WEIGHT RATING (GVWR) The GVWR is the manufacturer's assigned weight rating for the vehicle (truck, bus, or trailer), not the vehicle's registered weight. On trucks, the GVWR is usually found on a metal identification plate inside the driver's door. On trailers, it may be found anywhere but is commonly found on the front of the trailer on the driver's side. For Idaho, in the absence of a GVWR, the actual weight of the vehicle plus its heaviest load is considered to be the GVWR. Other states may use other definitions.

GROSS COMBINED WEIGHT RATING (GCWR): The GCWR is the total weight of the GVWRs of each unit of a combination vehicle (truck/tractor and trailer(s) added together.

Even if your vehicle is a commercial vehicle as defined above, you may still qualify for one of the federal and/or state CDL exemptions. There are four categories of CDL exemptions.

Recreational Vehicle Exemption: The Recreational Vehicle Exemption applies to drivers of vehicles used exclusively to transport personal possessions or family members for non-business or recreational purposes.

Military Vehicle Exemption: The Military Vehicle Exemption applies to military vehicle operators who are considered active-duty military personnel and to civilians who are required to wear uniforms and are subject to the Code of Military Justice.

Emergency Vehicle Exemption: The Emergency Vehicle Exemption applies to drivers of firefighting or other emergency equipment used in response to emergencies involving the preservation of life or property.

Farm Vehicle Exemption: The Farm Vehicle Exemption applies to drivers of farm vehicles, including family members and farm hands, under certain conditions only. The farm exemption applies to drivers of farm vehicles which are:

1. Controlled and operated by the farmer;
2. Used to transport agricultural products, supplies, and machinery to or from a farm;

3. Not used in common or contract carrier operations, and
4. Not driven more than 150 miles (“as the crow flies”) from the farm.

The farm exemption is intended for small farm-to-market operations only. It does not extend beyond the boundaries of Idaho unless there is a current reciprocity agreement in affect between states. Also, it does not include farmers who are transporting other farmers’ products if they are receiving any compensation for the services.

This manual provides you with the information necessary to pass all CDL written tests. Information regarding the skills test requirements is also included. The headings for each paragraph sub-section may help you locate specific topics of interest.

1.1 LICENSES AND ENDORSEMENTS

There are three types of commercial driver’s licenses: Class A, B and C. Drivers of vehicles that do not fall in Classes A, B, or C will be issued Class D (non-commercial) licenses.

1.1.1 License Classes

Class A: Combination vehicles with a gross combined weight rating (GCWR) of 26,001 or more pounds, provided the GVWR of the vehicle(s) being towed is greater than 10,000 pounds. Drivers with Class A licenses may, with the proper endorsements, operate vehicles requiring a Class B, C or D license.

Class B: Single vehicles with a GVWR of 26,001 or more pounds, or any such vehicle towing a vehicle under 10,000 pounds GVWR. Drivers with Class B licenses may, with the proper endorsements, operate vehicles requiring a Class C or D license.

Class C: Any single vehicle with a GVWR of 26,000 pounds or less that is hauling placarded hazardous materials or designed to transport 16 or more passengers, including the driver. Note: these vehicles can tow a vehicle not in excess of 10,000 pounds GVWR. Drivers with Class C licenses may also operate a class D vehicle.

1.1.2 Endorsements

You must have the appropriate endorsements on your CDL if you haul hazardous materials, pull double or triple trailers, operate a vehicle or pull a trailer with a tank, operate a passenger vehicle or school bus.

Hazardous Materials (H): Hazardous Materials (H) endorsement is required for drivers of vehicles transporting hazardous materials that require hazardous material placards per the Hazardous Materials Transportation Act. A written test and a TSA security threat assessment are required each time the driver renews his/her license.

Double/Triple (T): Double/Triple (T) endorsement is required for drivers of vehicles pulling two or three trailers. (A dolly or load divider, sometimes referred to as a “jeep” is considered to be one trailer.)

Tank vehicles (N): Tank vehicles (N) endorsement is required for drivers of vehicles designed to transport liquids or gaseous materials within a tank that is either permanently or temporarily attached to the vehicle or chassis. Such vehicles include, but are not limited to, cargo tanks and portable tanks, as defined in the hazardous materials regulations.

Passenger (P): Passenger (P) endorsement is required for drivers of vehicles designed to carry 16 or more passengers including the driver. Both written and skills tests are required to obtain this endorsement.

School Bus (S): School Bus (S) endorsement is required for drivers of vehicles used to transport preprimary, primary, or secondary school students from home to school, from school to home, or to and from school-sponsored events. Both written and skills tests are required to obtain this endorsement.

Motorcycle (M): Motorcycle (M) endorsement is required for motorcycle operators. Drivers must have an “M” endorsement on their Class D or Commercial Driver’s License to operate a motorcycle as defined by Idaho law (see the Idaho Motorcycle Operator Manual). A motorcycle means every motor vehicle having a seat or saddle for the use of the rider and designed to travel on not more than three wheels in contact with the ground, but excluding a tractor and moped. Motorcycle operators must pass a written and skills exam to add the endorsement.

Tank Vehicles/Hazardous Materials (X): Tank Vehicles/Hazardous Materials (X) is used when a driver has more endorsements on his/her license than their card will hold. The “X” endorsement represents the combination of both the tank vehicles (N) and hazardous materials (H) endorsements; therefore, a Class A CDL may show either an X or an N and H endorsement depending on the amount of other endorsements the driver may have on his/her license.

1.1.3 Restrictions

(L) Restriction – Air Brakes A: The (L) restriction prohibits driving of vehicles with air brakes. The CDL will carry this restriction unless you pass an air brakes knowledge test and a skills test (Pre-trip Inspection and Road Test) in a vehicle equipped with air brakes.

(M) Restriction – Except Class A Bus: The (M) restriction prohibits a driver with a passenger endorsement from operating a Class A bus if a Class A bus was not used for the skills test.

(N) Restriction – Except Class A and B Bus: The (N) restriction -Except Class A and B Bus - Restricts a CDL holder with the passenger endorsement from operating a Class A or B bus if a Class A or B bus was not used during their passenger endorsement skills test.

(Z) Restriction – Except Class A and B School Bus: The (Z) restriction -Except Class A and B School Bus - Restricts a CDL holder with the school bus endorsement from operating a Class A or B school bus if a Class A or B school bus was not used during their school bus endorsement skills test; however, the restriction does not apply to a driver who has previously obtained a passenger endorsement in a Class B bus, because he/she has already demonstrated the knowledge and skill level to operate Class B buses.

1.2 SEASONAL CDL FOR FARM-RELATED SERVICES

A Seasonal Commercial Driver's License is available to qualified seasonal drivers for certain farm-related service industries such as custom harvesters, farm retail outlets and suppliers, agrichemical businesses, and livestock feeders.

The Seasonal CDL is only valid within 150 miles of the business or farm being serviced. The Seasonal CDL is

valid (with a Class D license) for 180 days in a 12 month period, and can only be obtained twice in a lifetime.

The Seasonal CDL is not valid for driving Class A (combination) vehicles or passenger vehicles constructed to carry 16 or more people including the driver. The Seasonal CDL is not valid for driving vehicles carrying hazardous materials requiring placards except for diesel fuel in quantities of 1,000 gallons or less, liquid fertilizers in vehicles or implements of husbandry with total capacities of 3,000 gallons or less, or solid fertilizers that are not mixed or transported with any organic substance.

1.2.1 Requirements

To apply for a Seasonal CDL you must:

- Be at least 16 years of age.
- Have a valid Class D license.
- Have at least 1 year of driving experience in any type of motor vehicle.
- Have not violated the CDL single license requirements.
- Have not had any license suspensions, revocations or cancellations.
- Have not had any convictions in any vehicle for any of the following offenses:
 1. Excessive speeding (15 or more miles above the posted speed limit);
 2. Reckless driving;
 3. Improper or erratic lane changes;
 4. Following the vehicle ahead too closely;
 5. Driving a commercial motor vehicle without obtaining a CDL;
 6. Driving a commercial motor vehicle without a CDL in the driver's possession;
 7. Driving a commercial motor vehicle without the proper class of CDL and/or endorsements for the specific vehicle group being operated

or for the passengers or type of cargo being transported;

8. Violation of any other motor vehicle traffic control laws which result in a fatal traffic accident;
9. Driving while under the influence of alcohol or a controlled substance, including a refusal to test;
10. Leaving the scene of an accident, or
11. Using a vehicle to commit a felony.

The holder of a Seasonal CDL is subject to all disqualifying offenses and requirements applicable to CDL holders. Each applicant's driving record will be checked prior to issuance of a Seasonal CDL. Issuance of a Seasonal CDL will be entered on the Commercial Driver's License Information System (CDLIS).

The holder of a Seasonal CDL must pass the CDL General Knowledge written test. The Air Brakes test is also required if the vehicles to be driven are equipped with air brakes. Endorsement tests and skills tests are not required.

1.3 CDL LICENSE FEES

• CDL: One year (age 20)	\$15.00
• CDL: Three year (age 18 to 21)	\$30.00
• CDL: Four year (age 21 and over)	\$40.00
• Seasonal CDL (180 Days)	\$39.00
• CDL instruction permit	\$29.00
• Duplicate CDL or permit	\$15.00
• License upgrade	\$25.00
• Endorsement addition (after issuance of a CDL --does not include written test fee)	\$15.00
• Written tests (each)	\$3.00
• Skills test (\$10 to Driver's License Office, and \$60 to the Skills Tester)	\$70.00

1.4 HOW TO GET A CDL

To apply for a commercial driver's license, you must be at least 18 years old and either have a valid Idaho non-commercial license (Class D) or have passed all tests required to obtain one. You may be able to take your Class D license tests and your CDL tests at the same time; however, **you must have one year of documented driving experience in order to obtain a CDL.**

To apply for your CDL, go to your county Sheriff's office and bring your current driver's license, Social Security card, and money to pay your fees.

1.4.1 General Commercial Driver Qualifications: Individuals are qualified to drive a commercial vehicle in Idaho if they:

- Are at least 21 years of age for **Interstate** operations (traveling across state lines).
- Are at least 18 years of age for **Intrastate** operations (traveling only within the borders of Idaho).
- Can read and speak the English language sufficiently to talk with the general public; understand traffic signs and signals, and make entries on reports and records.
- Have the experience and/or training to safely operate a commercial vehicle.
- If not exempt under federal and/or state of Idaho law, carry a current medical examiner's certificate (DOT Medical Card) stating that he or she is physically qualified to drive a commercial vehicle (Federal Motor Carriers Safety Regulations Section 391 – Subpart E)
- Have a valid CDL issued from only (1) state or jurisdiction.
- Have provided his/her employer with a current list of traffic violations.
- Are not currently disqualified by the U.S. Department of Transportation (DOT) to drive a commercial vehicle.
- Have successfully passed the appropriate written examinations and road skills test for the

commercial vehicle(s) he/she intends to operate.

Providing false or incorrect information when applying for your driver's license may result in cancellation of your driving privileges and other penalties. If you obtain a CDL using false or incorrect information, you will be disqualified from operating a commercial motor vehicle for a period of 60 days. When applying for your CDL, your driving record will be checked, fees will be collected, and you will be required to take the necessary knowledge tests.

After passing the knowledge tests, you must schedule a skills test with a certified Idaho CDL Skills Tester. The sheriff's office will provide you with a list of Third Party Skills Testers. After passing the skills test, you may obtain your CDL at the sheriff's office.

1.4.2 Instruction Permits

A CDL instruction permit (also called a Commercial Learner's Permit or CLP) is available by taking the appropriate written tests for the type of vehicle you wish to operate. An instruction permit is valid for up to 180 days. Additional permits may be purchased if necessary. To qualify for a CDL Instruction Permit, you must:

- Be at least 18 years old.
- Hold a valid Idaho Class D driver's license.
- Have at least one year of documented driving experience.
- Be accompanied by a driver properly licensed to operate the vehicle you are driving. This person must occupy the seat beside the driver.

You must have in your possession a current Department of Transportation (DOT) Medical Certificate (if required to do so by Idaho law and/or the Federal Motor Carrier Regulations) and a CDL Instruction Permit whenever you need to practice driving a commercial vehicle prior to taking your skills test. The Medical Certificate and CDL Instruction Permit are required even if you are attending a professional truck driving school, company sponsored training program, or receiving private instruction from a friend in his/her own vehicle.

The only exception to this rule is if you take your skills test (without practice) following passing the written exams. In this case, you are not required to purchase a CDL Instruction Permit for the sole purpose of taking your skills test; however, as stated above, you will still have to have a current Medical Certificate in your possession if you are required to by state of Idaho or federal law.

The CDL Instruction Permit is just what it says; **"A Permit."** While operating a commercial vehicle with a permit, you cannot drive a commercial vehicle on public roadways under any circumstances without a qualified driver with you at all times, including driving a commercial vehicle to and/or from the skills test site. You have to have a valid CDL to operate the vehicle by yourself.

1.4.3 CDL tests

A CDL will be issued only after you have passed all of the required written and skills tests.

1.4.4 Knowledge Tests

All test results will remain valid for one year from the date they were passed. If the appropriate license is not issued within the one-year period, the tests must be retaken.

If you do not pass a test (knowledge or skills), you must wait three days before retaking the test (i.e., If you failed the test on Monday, you would be eligible to retest on Thursday). The test fees must be paid again.

CDL tests are not required at renewal time, with the exception of the Hazardous Materials knowledge test which must be passed prior to each renewal.

Applicants must take the knowledge tests for the class of license applied for and also the test(s) for any endorsement(s) they wish to hold. In the front of this manual following the Table of Contents, you will find a table showing you which sections of this manual to study for each test.

1.4.5 Skills Test

After passing the written tests, you must make an appointment with a Third Party Tester to take the skills test. The skills test will usually take about 2 hours to complete and must be taken in a vehicle that is representative of the license class you wish to operate.

If the vehicle used for the test is not equipped with air brakes, your CDL will show an (L) restriction stating that you are not licensed to operate vehicles equipped with air brakes.

Some examiners have vehicles that you can rent to take your skills test. If you rent a vehicle from them, they will have all of the appropriate vehicle documentation and insurance required by the state. If you use a vehicle other than an examiner's, you will need to bring proof of current insurance and vehicle registration. You will also need to bring proof of identification and your receipt showing you have passed the written tests and paid the skills test fee.

The skills test has three parts: the vehicle inspection, the basic control skills test, and the road test. **(Chapters 11, 12, and 13 tell you how to prepare for the skills test.)**

Special Note: The skills test is one test with three parts, not three separate tests; therefore, failing any part of the test counts as a failure for the entire test, and the entire test must be retaken.

After completing the testing process, please wait 24 hours to assure that the test results have been recorded by the Idaho Transportation Department (ITD). After completing the testing process, you may return to the Driver's License office to obtain your CDL. **You do not have the authority to operate a commercial vehicle until you obtain the CDL.**

1.5 MEDICAL REQUIREMENTS FOR CDL HOLDERS

Most people who drive Commercial Motor Vehicles (also called a CMV) are required to have a valid "DOT Medical Card" in their possession when driving a CMV. Some states require all persons who drive a CMV to be medically qualified.

A Department of Transportation (DOT) physical examination is conducted by a licensed "medical examiner." The term includes, but is not limited to, doctors of medicine (MD), doctors of osteopathy (DO),

physician assistants (PA), advanced practice nurses (APN), and doctors of chiropractic (DC).

To find a medical examiner to conduct the DOT physical exam you may contact your primary care provider to inquire if they will conduct a "DOT physical exam." You may also find a medical examiner in the yellow pages of your telephone book, or on the Internet by using an Internet directory or search engine. Look under "Occupational Health." If your medical examiner does not have a Medical Examination Report, one may be downloaded at the FMCSA website: <http://www.fmcsa.dot.gov/documents/safetyprograms/Medical-Report.pdf>

A DOT physical exam is valid for up to 24 months. The medical examiner may also issue a medical examiner's certificate for less than 24 months when it is desirable to monitor a condition, such as high blood pressure.

If the medical examiner finds that the person he/she examined is physically qualified to drive a CMV, the medical examiner will furnish one copy of the results to the person who was examined. You should ask your examiner for a "DOT wallet card" in addition to the long form exam report you will receive.

MEDICAL EXAMINER'S CERTIFICATE		
I certify that I have examined <u>Cameron Pike</u> in accordance with the Federal Motor Carrier Safety Regulations (49 CFR 391.41-391.49) and with knowledge of the driving duties, I find this person is qualified, and, if applicable, only when:		
<input checked="" type="checkbox"/> wearing corrective lenses	<input type="checkbox"/> driving within an exempt intracity zone (49 CFR 391.62)	
<input checked="" type="checkbox"/> wearing hearing aid	<input type="checkbox"/> accompanied by a Shift Performance Evaluation Certificate (SPE)	
<input type="checkbox"/> accompanied by a _____ waiver exemption	<input type="checkbox"/> Qualified by operation of 49 CFR 391.64	
The information I have provided regarding this physical examination is true and complete. A complete examination form with any attachment embodies my findings completely and correctly, and is on file in my office.		
SIGNATURE OF MEDICAL EXAMINER	TELEPHONE	DATE
	801-222-1111	06/06/06
MEDICAL EXAMINER'S NAME (PRINT)	<input type="checkbox"/> MD <input type="checkbox"/> DO <input type="checkbox"/> Chiropractor	
Jamie L. Wilson, PA	<input checked="" type="checkbox"/> Physician Assistant <input type="checkbox"/> Advanced Practice Nurse	
MEDICAL EXAMINER'S LICENSE OR CERTIFICATE NO./ISSUING STATE		
ME12345 / UT		
SIGNATURE OF DRIVER	DRIVER'S LICENSE NO.	STATE
Cameron Pike	987654321	UT
ADDRESS OF DRIVER		
123 Main Street, Any Town, UT 84003		
MEDICAL CERTIFICATE EXPIRATION DATE		
June 6, 2008		

Sample DOT Medical Card (wallet- card)

1.5.1 Qualifications For Drivers

When applying for a commercial driver's license, you will also be asked if you are subject to and in compliance with the requirements of Part 391 of the Federal Motor Carrier Safety Regulations (Qualifications of Drivers).

This requirement applies to CMV drivers who are or will be required to have a DOT Medical to perform the

driving functions they plan to do. These include the DOT medical card requirements.

Special Note: When you apply for a Commercial Driver's License, you will be asked this question: "I am subject to the Qualifications of Drivers, Federal Motor Carrier Safety Regulations, Part 391, including the DOT Medical Card Requirements, and I certify that I am in compliance with these requirements. Yes ___ No ___"

If you are required to possess a current DOT Medical Certificate to legally operate a Commercial Motor Vehicle under State of Idaho law or Federal Motor Carrier Safety Regulations, you must be able to pass the DOT physical examination and check the appropriate box on the application form.

If you are not medically qualified to drive a CMV in Interstate Commerce, but wish to drive in Idaho hauling exempt commodities, you should answer "NO" to this question.

If you only haul exempt commodities and are therefore not required to maintain a DOT Physical, you can answer "no" to this question.

If you knowingly are not medically qualified under the FMCSRs (i.e., blind in one eye, insulin dependent diabetic, etc.) and you check the box that you are in compliance with Part 391, you have falsified your application and the state may cancel your CDL.

1.5.2 Medical Card Exemptions For Commercial Driver Qualifications

MOST Commercial Vehicle operations are not exempt from the medical card requirement, even when operating only in Idaho.

Idaho follows Federal Motor Carrier Safety Administration (FMCSA) Requirements for DOT medical certification. **Idaho does not provide exceptions to the medical requirements; however, current Idaho law allows certain CDL Holders to drive a CMV without obtaining a medical card. These drivers can haul "Exempt" commodities and perform other types of truck and bus operations with a valid CDL as outlined in the following sections.**

1.5.3 Exempt Commodities List- Idaho

Commercial Driver's License holders who operate in IDAHO ONLY can legally transport the following exempt commodities without a DOT Medical Card in their possession:

- Bedding Plants
- Bees (apiary)
- Beet Pulp (for dairy feed)
- Christmas Trees
- Clay
- Coal
- Compost (soil aid)
- Dirt (equipment towed behind the truck to unload the dirt is regulated)
- Firewood
- Fish (Live fish in tanks)
- Fruits (fresh)
- Furniture (moving & storage)
- Fur Bearing Animals
- Grain
- Grass (sod)
- Gravel (Equipment towed behind the truck to unload the gravel is regulated)
- Hay (alfalfa)
- Hops
- Horses (riding, show, race, & rodeo)
- Household Goods
- Humus
- Livestock
- Livestock Feed/Silage
- Logs
- Mail
- Manure (fresh, dry, & dehydrated)
- Milk (bulk)
- Minerals (mined, unprocessed, Ore only)

Mobile/Modular Homes

Molasses (as livestock feed)

Mushrooms (fresh)

Newspapers & newsprint

Onions (bulk)

Ores (raw products of the Mine)

Peat Moss (bulk)

Pit Run

Potatoes (seed)

Potatoes (unprocessed)

Potato Waste (used for cattle Feed)

Poultry

Rock (Equipment towed behind the truck to unload the rocks is regulated)

Sand (Equipment towed behind the truck to unload the sand is regulated)

Sap (maple)

Silage

Sugar Beets

Top Soil (Equipment towed behind the truck to unload the top soil is regulated)

Wheat (farm)

Whey

Worms

A current, complete list of regulated and exempt commodities can be found on the Idaho State Police website:

<http://isp.idaho.gov/cvs/commodities.html>

1.5.4 Exempt Operations

Federal Motor Carrier Safety Regulations exempt drivers under certain circumstances from the DOT Medical card requirements **(but these operations are not exempt from CDL licensing requirements):**

Interstate or Foreign: Interstate drivers travel in the State of Idaho and also through other states.

- School bus operations. ***(see comment below)***
- Transportation performed by federal, state, or local governments.
- Occasional transportation of personal property.
- Transportation of sick and/or injured people or the deceased.
- The operation of fire trucks and rescue vehicles while involved in emergency and related operations.
- Farm custom operations.
- Apiarian industries. (Seasonal transportation of bees only)
- Certain farm vehicle drivers.

Intrastate: Intrastate drivers travel only within the borders of the State of Idaho:

- School bus operations. ***(see comment below)***
- Transportation performed by federal, state, or local governments.
- Occasional transportation of personal property.
- Transportation of sick and/or injured people or the deceased.
- The operation of fire trucks and rescue vehicles while involved in emergency and related operations.
- Apiarian industries (seasonal transportation of bees only).
- Farm vehicles used to transport the farmer's equipment or supplies.
- Vehicles used to transport agricultural products, livestock, or feed.
- Vehicles used to transport forest products.
- Vehicles used to carry mine products including sand, gravel, or aggregates. Petroleum products are not exempt.

- Wrecker or tow truck operations.
- Taxi service.
- Hotel service.
- Vehicles used to distribute newspapers.
- Vehicles used by airlines to transport customers or baggage.
- Intra-city movement of people or property.
- Vehicles used to transport household goods.

More information on Interstate exemptions specified under Federal Motor Carrier Safety Regulations (FMCSR) 390.3, 391.2, & 391.67 can be found at www.fmcsa.dot.gov

***The State of Idaho, Department of Education requires school bus operations to comply with Federal Motor Carrier Safety Regulations and requires their drivers to maintain a current DOT Medical card.**

1.6 SELF-CERTIFICATION REQUIREMENTS

Starting in July, 2013, new Federal Rules will apply to Commercial Driver's License applicants who:

- Apply for a CDL;
- Renew a CDL;
- Apply for a higher class of CDL;
- Apply for a new endorsement on a CDL; or
- Transfer a CDL from another State

Drivers will be required to "self-certify" (declare a category of commercial operation that they engage in or expect to engage in) when filling out their driver license application form. You will be asked which of the four following categories you plan to drive in. The categories are:

- | | |
|----------------------------------|-----------------------------------|
| Interstate, non- excepted | (medical card required) |
| Interstate, excepted | (no medical card required) |
| Intrastate, non-excepted | (medical card required) |
| Intrastate, excepted | (no medical card required) |

In most cases if you hold a valid medical card, you will want to declare your category "interstate, non-excepted".

Declaring an intrastate only category will result in a "K" restriction (intrastate operation only) being placed on your driving record/license. If you ONLY operate a CMV in Idaho and never cross state lines, you may declare an intrastate category if you wish.

Frequently asked questions on "self-certification" can be found on the ITD website at:

<http://itd.idaho.gov/dmv/driverservices/CDLMedicalFAQ.htm>

Based on your self- certification category, you may need to provide your Driver License Office with a current **medical examiner's certificate** and show any variance you may have to obtain or keep your CDL.

MEDICAL EXAMINER'S CERTIFICATE		
I certify that I have examined <u>Cameron Pike</u> in accordance with the Federal Motor Carrier Safety Regulations (49 CFR 391.41-391.45) and with knowledge of the driving duties, I find this person is qualified, and, if applicable, only when:		
<input checked="" type="checkbox"/> wearing corrective lenses <input checked="" type="checkbox"/> wearing hearing aid <input type="checkbox"/> accompanied by a _____ waiver exemption	<input type="checkbox"/> driving within an exempt intrastate zone (49 CFR 391.62) <input type="checkbox"/> accompanied by a Skill Performance Evaluation Certificate (SPE) <input type="checkbox"/> Qualified by operation of 49 CFR 391.64	
The information I have provided regarding this physical examination is true and complete. A complete examination form with any attachment embodies my findings completely and correctly, and is on file in my office.		
SIGNATURE OF MEDICAL EXAMINER	TELEPHONE	DATE
	801-222-1111	08/08/08
MEDICAL EXAMINER'S NAME (PRINT)	<input type="checkbox"/> MD <input type="checkbox"/> DO <input type="checkbox"/> Chiropractor <input checked="" type="checkbox"/> Physician Assistant <input type="checkbox"/> Advanced Practice Nurse	
MEDICAL EXAMINER'S LICENSE OR CERTIFICATE NO./ISSUING STATE <u>ME 12345 / UT</u>		
SIGNATURE OF DRIVER	DRIVER'S LICENSE NO.	STATE
<u>Cameron Pike</u>	987654321	UT
ADDRESS OF DRIVER <u>123 Main Street, Any Town, UT 84003</u>		
MEDICAL CERTIFICATE EXPIRATION DATE <u>June 6, 2008</u>		

Sample Medical Examiner's Certificate, also known as a "DOT Medical Card"

1.7 COMPLIANCE SAFETY ACCOUNTABILITY (CSA) INFORMATION

Compliance, Safety, Accountability (CSA), is a program administered by the Federal Motor Carrier Safety Administration (FMCSA) under authority of the U.S. Department of Transportation, to improve commercial truck and bus safety by reducing crashes, injuries, and fatalities related to commercial motor vehicles. CSA began in 2010.



Since the 1970s, Federal and State enforcement efforts have progressively reduced the rate of CMV crashes resulting in injuries or fatalities on our Nation's highways. The rate of crash reduction slowed, prompting the FMCSA to develop a new way to evaluate the safety of motor carriers and drivers.

FMCSA wanted to improve its safety monitoring, evaluation, and intervention processes. Compliance, Safety, Accountability (CSA) is the result of this effort.

The three main components of CSA are:

1. Compare safety records of carriers and drivers known as "Behavior Analysis and Safety Improvement Categories" or BASICS.
2. Evaluate safety performance of carriers and drivers and identify behavior patterns that may result in unsafe operations.
3. Take necessary tailored steps to correct safety violations and procedures necessary to ensure future compliance.

Carriers are held accountable for all safety-based violations recorded during roadside inspections. Drivers are responsible for compliance with some vehicle maintenance regulations. For example, drivers are required, by regulation, to do a pre-trip vehicle inspection to ensure that the vehicle is safe.

BASIC "scores" are determined by the results of the motor carrier's on-road performance over the previous 24 months and the investigation results over the previous 12 months. Overall Status will display a  symbol if either the on-road performance's percentile is over the established threshold or the investigation results show the discovery of a Serious Violation. This indicates that the BASIC is  and the motor carrier may be prioritized for an intervention, which can include a warning letter, investigation, and identification for a roadside inspection.

CSA does not assign formal safety ratings to individual drivers; however, the agency recognizes that holding drivers accountable for safe driving behavior is an important part of the safety compliance and enforcement process.

Tickets or warnings that drivers receive while operating their personal vehicles do not count; only violations of Federal Motor Carrier Safety Regulations (and those regulations apply only to people driving commercial motor vehicles).

Commercial Drivers should become familiar with what CSA is and how it affects them and their employer.

Safety ratings of carriers and further information on CSA can be found at: www.csa.fmcsa.dot.gov

RESOURCES:

It is very important for drivers to research and know the laws regarding medical certification for the loads they will be transporting.

The Federal Motor Carrier Safety Regulations may be found on the internet at www.fmcsa.dot.gov

Printed books with current FMCSA regulations may be purchased from the:

Idaho Trucking Association
5171 Overland Road
Boise, ID 83705
Phone: (208) 342-3521

<http://www.idtrucking.org/>

For guidance on exempt and regulated commodities, hazardous materials, etc. contact:

**Idaho State Police
Commercial Vehicle Safety Unit
(208) 884-7220**

For specific guidance on medical card requirements & driver medical qualification issues such as diabetes, vision limitations, loss of limbs, etc. contact:

**Federal Motor Carrier Safety Administration
Boise Field Office
(208) 334-1842**

For general guidance on CDL Licensing requirements, contact:

**Idaho Transportation Department
Driver Services
(208) 334-8735**

1.8 SAFETY RULES

There are other federal and state laws which affect drivers operating commercial motor vehicles in all states. Violations of these rules could result in both civil

and criminal penalties or disqualify you from driving commercial vehicles.

- You cannot have more than one license, and the license you do have must be issued from the state in which you reside. If you move to a new state, you must obtain a CDL from that state within 30 days.
- It is your responsibility as an Idaho driver to keep a current address on file with the Idaho Transportation Department. If you move, you must notify the department in writing of the old and new address within 30 days. **NOTE: It is extremely important (and it's the law) to make sure your mailing address on file is correct. This is especially important for CDL holders! In the photo below, none of these commercial drivers received an important legal update; their letters were returned to ITD undeliverable as addressed. Don't let your mail end up here!**



- You must notify your employer within 30 days of a conviction for any traffic violation (except parking). This is true no matter what type of vehicle you were driving.
- You must notify your employer if your license is suspended, revoked, or canceled, or if you are disqualified from driving. You must make this

notification before the end of the business day following the day you receive the notice of suspension, revocation, cancellation, loss of privileges, or disqualification.

- You must give your employer information on all driving jobs you have held for the past 10 years. You must do this when you apply for a commercial driving job.

No one can drive a commercial vehicle without a valid CDL. A court may fine you up to \$5000 or put you in jail for breaking this rule.

Your employer may not let you drive a commercial vehicle if you have more than one license, or if your CDL is suspended, revoked or disqualified. A court may fine the employer up to \$5000 or put him/her in jail for breaking this rule.

1.9 CENTRAL ISSUE OF DRIVER'S LICENSES

- All Idaho driver's licenses are now issued from a central location.
- You will receive a temporary card printed on security paper before you leave your local licensing office
- The temporary card includes your photo and all the information included on the plastic card (name, address, date of birth, height, weight, etc.)
- The temporary card will be issued for driving and identity purposes
- The new card will be mailed to you within about 10 business days.
- When the plastic card arrives in the mail, the temporary document should be destroyed.

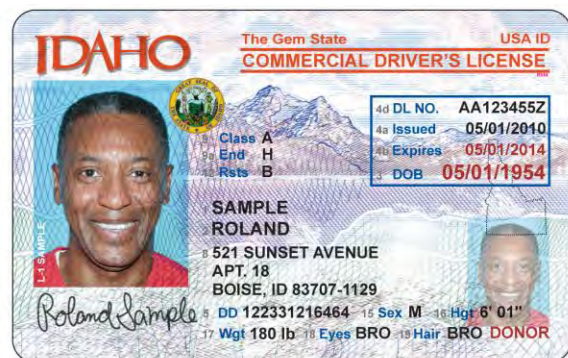

Example of Idaho Commercial Driver's License

1.10 DISQUALIFICATIONS

Serious Traffic Violations: You will lose your CDL for 60 days if you are convicted of two serious traffic violations, or 120 days if convicted of three serious traffic violations in a three year period. The term “conviction” includes forfeiture of bail or bond and withheld judgments. These violations must have been committed while operating a commercial motor vehicle. The following are serious traffic violations:

- Excessive speed (15 or more miles above the posted speed limit).
- Reckless driving.
- Improper or erratic lane changes.
- Following the vehicle ahead too closely.
- Texting or using a hand-held mobile phone while driving a CMV
- Traffic offenses committed in a CMV in connection with fatal traffic accidents.
- Violation of any other motor vehicle traffic control laws which result in a fatal traffic accident.
- Driving a commercial motor vehicle without obtaining a CDL.
- Driving a commercial motor vehicle without a CDL in the driver’s possession.
- Driving a commercial motor vehicle without the proper class of CDL and/or endorsements for the specific vehicle group being operated or for the passengers or type of cargo being transported.

Violation of an Out-of-Service Order: If you are (1) convicted, (2) forfeit bond, or (3) receive a withheld judgment for a violation of an out-of-service order while driving a commercial motor vehicle, you will be disqualified for:

- 180 days for a first conviction;
- Two (2) years for a second conviction in 10 years, and

- Three years for subsequent convictions in 10 years.

If transporting hazardous materials or driving a bus (designed to carry 16 or more people) at the time, the driver is disqualified for:

- 180 days for a first conviction, and
- Three years for subsequent convictions in 10 years.

An out-of-service order issued by an authorized enforcement officer is defined as a temporary prohibition against operating a commercial motor vehicle. The order is issued in response to a violation of federal regulations, compatible laws, or to the North American uniform out-of-service criteria (CVSA).

Disqualification for Conviction of a Railroad-Grade Crossing Violation: If you are (1) convicted, (2) forfeit bond, or (3) receive a withheld judgment for a railroad grade crossing violation as specified in 49 CFR Part 383 or applicable state laws while driving a commercial motor vehicle, your commercial driving privileges will be disqualified for:

- 60 days for a first conviction;
- 120 days for a second conviction during any three year period, and
- One year for a third or subsequent conviction during any three year period.

Disqualification for Controlled Substance or Alcohol Violations, Leaving the Scene of an Accident, and Felonies

You will lose your CDL for at least **One Year** for a first time offense:

- If you drive a motor vehicle under the influence of alcohol or a controlled substance such as an illegal drug. If you drive a commercial vehicle when your blood alcohol concentration is .04 percent or more, or any vehicle when your blood alcohol concentration is .08 or higher, you are driving under the influence of alcohol. If your alcohol concentration is less than .04% but you have any detectable amount, you will be placed “out of service” for 24 hours.

- If you refuse to take an evidentiary test for alcohol or other intoxicating substances while you are operating a motor vehicle.
- If you leave the scene of an accident involving a motor vehicle you were driving
- If you use a motor vehicle to commit a felony
- If you drive a commercial vehicle when, as a result of prior violations committed operating a commercial vehicle, your CDL is revoked, suspended, or cancelled or you are disqualified from operating a commercial vehicle
- If you cause a fatality through the negligent operation of a commercial vehicle, including but not limited to, the crimes of motor vehicle manslaughter, homicide by motor vehicle, or negligent homicide.

You will lose your CDL for at least **Three years** for a first offense if any of the above offenses occur while you are operating a commercial vehicle that is transporting hazardous materials that are required to be placarded by the Hazardous Materials Transportation Act.

You will lose your CDL for **Life** if you are convicted, forfeit your bond, or receive a withheld judgment for any of these disqualifying offenses, or any combination of these offenses, for a second time.

You will lose your CDL for **Life** if you use a motor vehicle to commit a felony involving the manufacture, distribution, or dispensing of a controlled substance.

1.11 ALCOHOL TESTS AND THE LAW (IMPLIED CONSENT)

When you accept an Idaho driver's license of any kind, you give your implied consent to take an alcohol concentration test if you are suspected of driving under the influence. If you refuse to take the test when requested to do so by a law enforcement officer or submit to and fail a test for BAC your CDL privileges are subject to disqualification under the provisions of Section 49-335, Idaho Code.

1.12 ADMINISTRATIVE LICENSE SUSPENSIONS (ALS)

Your driving privileges will be suspended under Section 18-8002A, Idaho Code, if you fail an evidentiary test for any of the following reasons:

- Having a blood alcohol concentration of .08% or greater while operating or being in actual physical control of **any motor vehicle**.
- Having a blood alcohol concentration of .04% or greater while operating or being in actual physical control of a **commercial motor vehicle**.
- Having test results indicating the presence of drugs or other intoxicating substances.

The suspension will become effective 30 days from the date the *Notice of Suspension* is issued upon failure of an evidentiary test. If you are driving a Commercial Motor Vehicle (CMV) at the time of your arrest, your commercial privileges are lost immediately and will remain suspended throughout the administrative process.

Penalties

First offense: While operating any vehicle (BAC .08% or greater) or a commercial vehicle* (BAC .04% or greater)-

- CDL driving privileges: **One Year** absolute disqualification of commercial vehicle driving privileges.
- Class D driving privileges: 90-day suspension with absolutely no driving privileges for the first 30 days. Restricted driving privileges that allow for the operation of a non-commercial vehicle may be requested for the remaining 60 days of the suspension.

Second offense: While operating any vehicle (BAC .08% or greater) or a commercial vehicle* (BAC .04% or greater)-

- CDL driving privileges: **Lifetime** disqualification.
- Class D driving privileges: one year suspension with absolutely no driving privileges of any kind.

***If the failure(s) occurred in a commercial vehicle (BAC.04 to less than .08%), Class D driving privileges will remain valid.**

These suspensions are separate from any additional penalties or suspensions imposed by the court as a result of being convicted of the offense. Additional information on this law may be found in the Idaho Driver's Manual. A periodic review of both manuals is recommended for all commercial drivers.

1.13 DRUG AND ALCOHOL TESTING

All drivers subject to CDL requirements are also required to participate in a controlled-substance and alcohol-testing program. These requirements include random, reasonable suspicion, post-accident, return-to-duty, and follow-up testing for controlled substances and alcohol. Pre-employment controlled substance testing is also required.

1.14 DRIVER RECORD REQUESTS

You can obtain a copy of your Idaho driving record by completing an "Idaho Motor Vehicle Driver's License Record Request" form (**See Figure 1.1**) and paying a small fee. The Driver's License Request (DLR) form can be obtained at the following locations:

- Most County Sherriff's offices
- On the State of Idaho website at: <http://www.accessidaho.org>

Depending on your circumstances, you can travel to the closest County Sherriff's office, fill out the form, pay the fees and receive your record while you wait. You may also fax or mail the form to the ITD, or complete the application on the State of Idaho's website.

Figure 1.1

ITD 3120 (Rev. 01-10)
Supply # 01-953002-1

Idaho Motor Vehicle Driver's License Record Request



If the request is mailed, please enclose the proper fee.

- Do not send cash in the mail.
- Make check or money order payable to the Idaho Transportation Department.
- No refunds will be processed whether or not a record is found.

<i>In accordance with Idaho Code Section 49-202, and Administrative Rule No. 39.02.41, I hereby request the driving record(s) of the following:</i>			Use 1, 2, 3 or 4 From Fee Schedule Below	Mark One	
Name	Driver's License Number	Date of Birth		3-Year Record	Entire Record
Requester's Name			Telephone (If None, State "None")		
Requester's Address		City	State	Zip	
Registered Account Number (If Applicable)			<input type="checkbox"/> Fax back to _____ (Return Faxes for Personal Requests Only)		
Authorization Statement					
In order to receive motor vehicle or driver records under <i>Idaho Code Section 49-203</i> (see list on page 2), I certify that I meet the authorization requirements and that the use of such information will be strictly limited to the use described.					
Requester's Signature		Date	Authorization (Use Major Heading Only)		
Complete if Paying by Credit Card	<input type="checkbox"/> VISA <input type="checkbox"/> MasterCard	Credit Card Number	Card Expiration Date	Authorization Signature	
FEE SCHEDULE			ADDRESS		
1. Driver's License Record (DLR)..... 7.00			DRIVER SERVICES IDAHO TRANSPORTATION DEPARTMENT Mailing Address: PO BOX 34, BOISE ID 83731-0034 Street Address: 3311 W. State St., Boise ID 83703 Phone (208) 334-8736 Fax (208) 334-8739		
2. Photocopy per document..... 7.00					
3. Certification of the Record (Additional)..... 14.00					
4. DLR plus copies of File Documents..... 14.00 (i.e., Citations, Suspension Orders, etc.)					
TOTAL REMITTANCE \$ _____					

Idaho Motor Vehicle Driver's License Record Request

Categories of Requesters Who May be Authorized to Receive Personal Information Under *Idaho Code 49-203**

1. **GOVERNMENT:** For use by any government agency, including any court or law enforcement agency, in carrying out its functions or any private person or entity acting on behalf of a federal, state, or local agency in carrying out its functions.
2. **DRIVER OR VEHICLE SAFETY:** For use in matters of motor vehicle or driver safety and theft, such as motor vehicle emissions, motor vehicle product alterations, recalls or advisories; performance monitoring of motor vehicles, motor vehicle parts, and dealers; motor vehicle market research activities, including survey research; and removal of non-owner records from the original records of motor vehicle manufacturers.
3. **BUSINESS ACTIVITIES:** For use in the normal course of business by a legitimate business or its agents, employees or contractors, but only:
 - a. To verify the accuracy of personal information submitted by the individual to the business or its agents, employees, or contractors.
 - b. If such information as submitted is not correct or is no longer correct, to obtain the correct information, but only for the purpose of preventing fraud by pursuing legal remedies against or recovering on a debt or security interest against the individual.
4. **COURT PROCEEDINGS:** For use in connection with any civil, criminal, administrative or arbitral proceeding in any federal, state, or local court or agency or before any self-regulatory body, including the services of process and investigation in anticipation of litigation, and the execution or enforcement of judgments and orders or pursuant to any order of a federal, state, or local court.
5. **RESEARCH:** For use in research activities and for use in producing statistical reports, so long as personal information is not published, re-disclosed, or used to contact individuals.
6. **INSURANCE:** For use by any insurer or insurance support organization (or by a self-insured entity) or its agents, employees, or contractors in connection with claims investigation activities, rating, or underwriting.
7. **TOWED/IMPOUNDED VEHICLES:** For use in providing notice to the owners of towed or impounded vehicles.
8. **INVESTIGATION:** For use by any licensed private investigative agency or licensed security service for any purpose permitted under the provisions of *Idaho Code Title 49*.
9. **EMPLOYER INFORMATION:** For use by an employer or its agent or insurer to obtain or verify information relating to a holder of a commercial driver's license that is required under the Commercial Motor Vehicle Safety Act of 1986 (*49 USC 31101 et seq.*).
10. **PUBLIC SAFETY/VEHICLE OPERATION:** For any other use specifically authorized under *Idaho Code*, if such use is related to public safety or the operation of a motor vehicle.
11. **TRANSPORTATION FACILITIES:** For use in connection with the operation of private toll transportation facilities, including companies that operate parking facilities for the purpose of providing notice to the owners of vehicles who have used the facility.
12. **WRITTEN CONSENT GIVEN:** The individual being inquired about has authorized the requestor in writing to have access to their personal information. A verified copy of the signed authorization must be included with the DLR request. Unless specifically stated, the individual's photograph, digitized signature, social security number, and medical or disability information will not be disclosed.*

*Release of an individual's photograph, digitized image of a photograph, digitized signature, social security number, and medical or disability information may not be disclosed without the written consent of the person to whom such information pertains, except for uses permitted under *Idaho Code Section 49-203, subsections (4)(a) and (4)(d)*.

Chapter 2 : Driving Safety

This Chapter Covers:

- 🔊 Vehicle Inspection
- 🔊 Basic Control of Your Vehicle
- 🔊 Shifting Gears
- 🔊 Seeing
- 🔊 Communicating
- 🔊 Space Management
- 🔊 Controlling Your Speed
- 🔊 Seeing Hazards
- 🔊 Distracted Driving
- 🔊 Aggressive Drivers/Road Rage
- 🔊 Night Driving
- 🔊 Driving in Fog
- 🔊 Winter Driving
- 🔊 Hot Weather Driving
- 🔊 Railroad-highway Crossings
- 🔊 Mountain Driving
- 🔊 Driving Emergencies
- 🔊 Antilock Braking Systems
- 🔊 Skid Control and Recovery
- 🔊 Accident Procedures
- 🔊 Fires
- 🔊 Alcohol, Other Drugs, and Driving
- 🔊 Staying Alert and Fit to Drive
- 🔊 Hazardous Materials Rules
- 🔊 Sharing the Road

This chapter contains knowledge and safe driving information that all commercial drivers should know. You must pass a test on this information to get a CDL. This section does not have specific information on air brakes, combination vehicles, doubles/triples, passenger or school bus vehicles. When preparing for the Pre-Trip Inspection Test, you must review the material in Chapter 11 in addition to the information in this section. This chapter does have basic information on hazardous materials (HazMat) that all drivers should know. If you need a HazMat endorsement, you should study Chapter 9.

2.1 VEHICLE INSPECTION

Safety for yourself other drivers and pedestrians is the most important reason you inspect your vehicle.

2.1.1 Why Inspect

A vehicle defect found during an inspection could save you problems later. You could have a breakdown on the road that will cost time and dollars, or even worse, a crash caused by the defect. Federal and state laws require that drivers inspect their vehicles. Federal and state inspectors also may inspect your vehicles, and if they judge the vehicle to be unsafe, they will put it “out of service” until it is fixed.

2.1.2 Types of Vehicle Inspection

Pre-trip Inspection and Report: A pre-trip inspection will help you find problems that could cause a crash or breakdown. If the motor carrier is required to have their drivers prepare a Driver Vehicle Inspection Report by the Federal Motor Carrier Safety Regulations (FMCSR), you **must** review the last driver vehicle inspection report at the beginning of your workday to ensure any items listed on the last report that affect the safety of the vehicle have been repaired or were found to be unnecessary by the mechanic performing the repairs. The mechanic must certify the repairs were performed by placing his/her signature on the original inspection report. You **must** sign the same report certifying you have reviewed the report and accept the vehicle. You do not have to sign a report from the previous driver if no defects or deficiencies were noted. You also do not have to sign the inspection report for a towed unit (trailer(s) if the unit isn’t part of the current vehicle combination.

During a Trip: For safety you should-

- Watch the gauges for signs of trouble.
- Use your senses to check for problems (look, listen, smell, feel).

Check critical items when you stop:

- Tires, wheels and rims.
- Brakes.
- Lights and reflectors.
- Brake and electrical connections to trailer.

- Trailer coupling devices.
- Cargo restraining devices (cargo bars, chains, binders, straps, rope, etc).

Post-trip Inspection and Report: You should do a post-trip inspection at the end of the trip, day, or tour of duty on each vehicle you operated. If the motor carrier is required to have their drivers prepare a Driver Inspection Report by the Federal Motor Carrier Safety Regulations, you **must** prepare a written inspection report at the completion of each day's work on each vehicle operated. You **must** identify the vehicle you operated and list any defect or deficiency that would affect the safe operation of the vehicle and/or any towed unit (trailer(s) that would cause the equipment to suffer a mechanical breakdown. You **must** also prepare a written report if no equipment defect or deficiency is found. In all instances, you must sign the report. If there are two (2) drivers in the same vehicle, only one has to sign the report, providing both drivers agree to the operational condition of the equipment.

The Driver's Inspection Report notifies the motor carrier of the condition of the equipment and identifies any defects or deficiencies found that would make the unit(s) unsafe or cause it to break down. Depending on the motor carrier's policy regarding the distribution of the inspection report, if possible, you should leave a copy of the inspection report in the vehicle for at least a day so it can be reviewed by the next driver.

2.1.3 What to Look For:

Tire Problems:

- ✓ Check for too much or too little air pressure.
- ✓ Check tire wear. You need at least 4/32-inch tread depth in every major groove on front tires. You need 2/32 inch on other tires. No fabric should show through the tread or sidewall.
- ✓ Check for cuts or other damage.
- ✓ Check for tread separation.

- ✓ Check dual tires to see that they do not come into contact with each other or parts of the vehicle.
- ✓ Check for mismatched tire sizes.
- ✓ Check to see that radial and bias-ply tires are not used together.
- ✓ Check for cut or cracked valve stems.
- ✓ Check to see that re-grooved, recapped, or retreaded tires are not on the front wheels of a bus (prohibited by law).

Wheel and Rim Problems:

- ✓ Check for damaged rims.
- ✓ Check for rust around wheel nuts which may indicate that the nuts are loose and check to ensure wheel nuts are tight. After a tire has been changed, stop a short while later and re-check tightness of nuts.
- ✓ Check for missing clamps, spacers, studs, or lugs.
- ✓ Check for mismatched, bent, or cracked lock rings.
- ✓ Check wheels or rims to ensure they have not have had welding repairs.

Bad Brake Drums/Rotors/Linings/Pads:

- ✓ Check brake drums or rotors to ensure they are not cracked, dented, have holes or missing bolts.
- ✓ Check brake shoes or pads for oil, grease, or brake fluid on them.
- ✓ Check brake shoes or pads to ensure they are not worn dangerously thin (Linings should be at least a minimum of 1/4 inch thick or more – pads should not be dangerously thin or scarring

the rotor). Make sure no linings or pads are missing, damaged, or broken.

Steering System Defects: Missing nuts, bolts, cotter keys, or other parts:

- ✓ Check for bent, loose, or broken parts, such as steering column, steering gear box, or tie rods. Check power steering components (if so equipped). Check hoses, pumps, and fluid level and check for leaks.
- ✓ Check steering wheel to ensure it does not have more than 10° (approximately 2 inches movement at the rim of a 20 inch steering wheel) play. You must have the engine running to check the play in vehicle with power steering.

Figure 2.1 illustrates a typical steering system.



Suspension System Defects: The suspension system holds up the vehicle and its load. It keeps the axles in place; therefore, broken suspension parts can be extremely dangerous. Look for the following problems:

- ✓ Check spring hangers to ensure they do not allow movement of the axle from its proper position (See Figure 2.2).
- ✓ Check for cracked or broken spring hangers

- ✓ Check for missing or broken leaves in any leaf spring. If 1/4 or more of the leaves are missing, it will put the vehicle "out of service."
- ✓ However, any broken or missing spring is a defect that could be dangerous (See figure 2.3).
- ✓ Check for broken leaves in a multi-leaf spring or leaves that have shifted so they might hit a tire or other part of the vehicle.
- ✓ Check for leaking or broken shock absorbers.
- ✓ Check the torque rod or arm, u-bolts, spring hangers, or other axle positioning parts to ensure they are not cracked, damaged, or missing.
- ✓ Check air suspension systems for damage and/or leaks (See figure 2.4).
- ✓ Check for any loose, cracked, broken, or missing frame members.

Figure 2.2

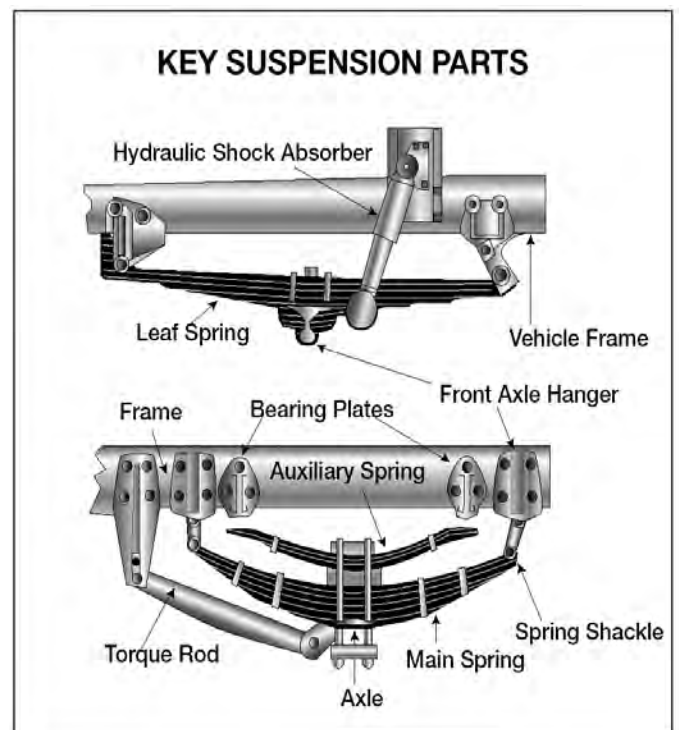



Figure 2.3

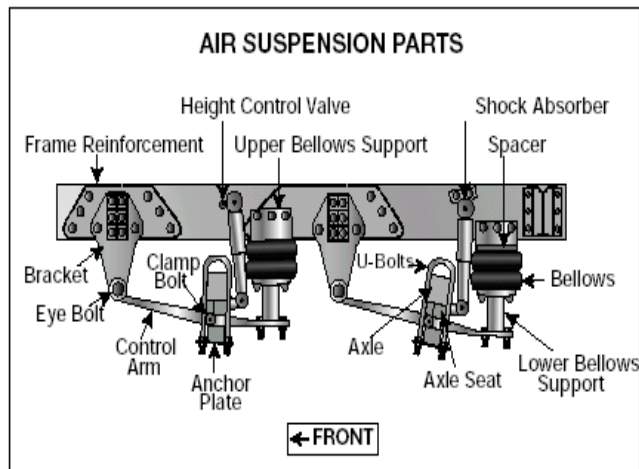

Figure 2.4

Exhaust System Defects: A broken exhaust system can let poison fumes into the cab or sleeper berth. Look for the following problems:

- ✓ Check for loose, broken, damage or missing exhaust pipes, mufflers, tailpipes, or vertical stacks.
- ✓ Check for loose, broken, or missing mounting brackets, clamps, bolts, or nuts.
- ✓ Check to see that exhaust system parts are not rubbing against fuel system parts, tires, or other moving parts of vehicle.
- ✓ Check to see that exhaust system parts are not leaking.

Emergency Equipment: All commercial vehicles must be equipped with emergency equipment. Look for the following:

- ✓ Check for Fire extinguisher(s). They must be properly charged, rated and labeled fire extinguisher(s) securely mounted in a readily accessible location.
- ✓ Check for spare electrical fuses (unless equipped with circuit breakers).
- ✓ Check for warning devices for parked vehicles (i.e., three reflective warning triangles, flares etc).

Cargo (Trucks): You must make sure the truck is not over loaded, and the cargo is balanced and secured before each trip. If the cargo contains hazardous materials, you must inspect it for proper papers and placarding.

2.1.4 CDL Pre-trip Vehicle Inspection Test:

In order to obtain a CDL, you will be required to pass a pre-trip vehicle inspection test. You will be tested to see if you know whether your vehicle is safe to drive. You will be asked to do a pre-trip inspection of your vehicle (and trailer if any) and explain to the examiner what you would inspect and why. The following seven-step inspection method should help you do a thorough pre-trip inspection.

2.1.5 Seven-Step Inspection Method:

Method of Inspection: You should do a pre-trip inspection the same way each time so you will learn all of the steps and be less likely to forget something.

Approaching the Vehicle: Notice the general condition of the vehicle. Look for damage or the vehicle leaning to one side. Look under the vehicle for fresh oil, coolant, grease, or fuel leaks. Check the area around the vehicle for hazards to the vehicle's movement (people, other vehicles, objects, low-hanging wires, limbs, etc.).

Vehicle Inspection Guide

Step 1: Vehicle Overview

Review the Last Driver Vehicle Inspection Report. If the motor carrier is required to have their drivers prepare a Driver Vehicle Inspection Report by the Federal Motor Carrier Safety Regulations, you **must** review the last driver vehicle inspection report at the beginning of your workday to ensure any items listed on the last report that affect the safety of the vehicle have been repaired or were found to be unnecessary by the mechanic performing the repairs. The mechanic must certify the repairs were performed by placing his/her signature on the original inspection report. You **must** sign the same report certifying you have reviewed the report and accept the vehicle. You do not have to sign a report from the previous driver if no defects or deficiencies were noted. You also do not have to sign the inspection report for a towed unit (trailer(s) if the unit isn't part of the current vehicle combination.

Step 2: Check Engine Compartment

Check That the Parking Brakes Are On and/or Wheels Chocked. You may have to raise the hood, tilt the cab (secure loose things so they don't fall and break something), or open the engine compartment door. Check the following:

- ✓ Check the engine oil level.
- ✓ Check engine coolant level in the radiator and also the condition of the hoses.
- ✓ Check the power steering fluid level and condition of the hoses (if so equipped).
- ✓ Check the windshield washer fluid level.
- ✓ Check the battery fluid level (if not a sealed unit), cable connections and condition and tie downs (battery may be located elsewhere).
- ✓ Check the automatic transmission fluid level if the vehicle is so equipped (may require engine to be running).

- ✓ Check engine belts for tightness and excessive wear (alternator, water pump, air compressor). Learn how much "give" the belts should have when adjusted correctly and check each one.
- ✓ Check for leaks in the engine compartment (fuel, coolant, oil, power steering fluid, hydraulic fluid, battery fluid).
- ✓ Check for cracked broken or worn electrical wiring insulation.
- ✓ Check to see that engine fan blade is secure, not damaged or missing blades, not touching the radiator or other engine components.
- ✓ Lower and secure the hood, cab, or engine compartment door.

Step 3: Start Engine and Inspect Inside the Cab

Get In the Vehicle and Start the Engine

- ✓ Check to make sure the parking brake(s) is on.
- ✓ Put the gearshift in neutral or park.
- ✓ Start the engine and listen for unusual noises.

Look at the Gauges

- ✓ Check oil pressure: The pressure should come up to normal within seconds after engine is started (**See Figure 2.5**).
- ✓ Check air pressure: The pressure should build from 50 to 90 psi within 3 minutes.
- ✓ Check ammeter and/or voltmeter: The needle should be in normal range(s).
- ✓ Check engine coolant temperature: Should begin gradual rise to normal operating range.
- ✓ Check engine oil temperature: Should begin gradual rise to normal operating range.

- ✓ Check warning lights and buzzers: Oil, coolant, charging circuit warning, and antilock brake system lights should go out right away.

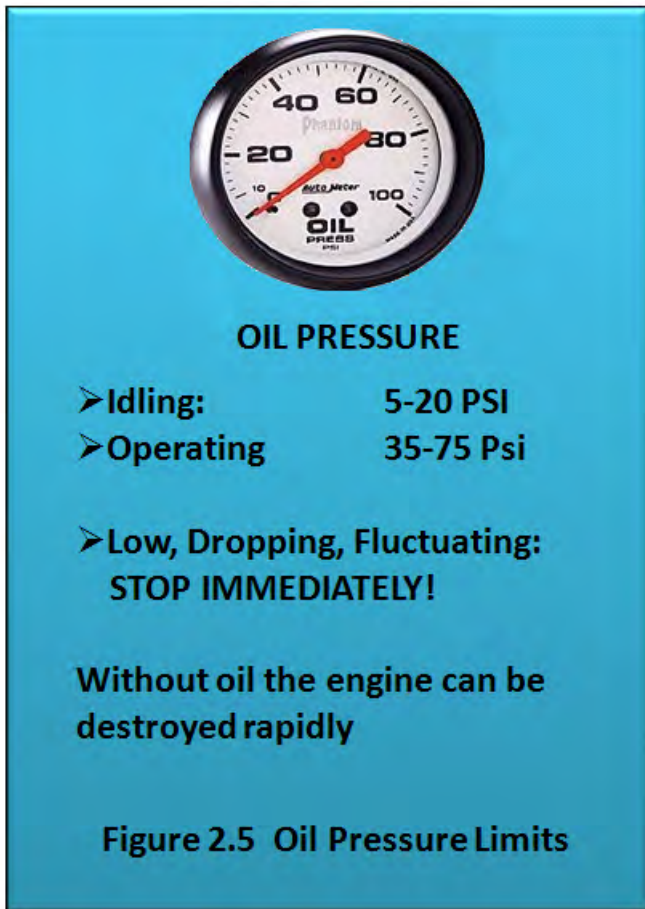

Check Condition of Controls: Check all of the following for looseness, sticking, damage, or improper setting:

- ✓ Check the steering.
- ✓ Clutch.
- ✓ Accelerator (gas pedal).
- ✓ Brake controls:
 - Foot brake.
 - Trailer brake (if vehicle has one).
 - Parking brake(s).

- Engine retarder controls – also known as a “Jake Brake” (if the vehicle is so equipped).
- ✓ Transmission controls.
- ✓ Inter-axle differential lock (if vehicle has one).
- ✓ Horn(s).
- ✓ Windshield wiper/washer.
- ✓ Lights:
 - Headlights.
 - Dimmer switch.
 - Turn signal.
 - Four-way flashers.
 - Parking, clearance, identification, and marker light switches.

Check Mirrors and Windshield: Inspect mirrors and windshield for cracks, dirt, illegal stickers, or other obstructions that would prevent you from seeing clearly. Clean, adjust, repair/replace as necessary.

Check Emergency Equipment: Check for the following safety equipment:

- ✓ Check of spare electrical fuses (unless vehicle has circuit breakers).
- ✓ Check for three red reflective triangles.
- ✓ Check for a properly charged and rated fire extinguisher.
- ✓ Check for optional items such as:
 - Chains (where winter conditions require).

- Tire changing equipment (if the vehicle is so equipped).
- List of emergency phone numbers.
- Accident reporting kit (packet).

Step 4: Turn Off Engine and Check Lights

Make sure the parking brake(s) is set, turn off the engine, and take the key with you. Turn on the headlights (low beams) and four-way emergency flashers, and get out of the vehicle.

Step 5: Do a Walk-Around Inspection

- ✓ Go to front of vehicle and check that the low beams are on and both of the four-way flashers are working.
- ✓ Check to see that the license plate(s) is present, clean, secured and has a current registration sticker.
- ✓ Turn off headlights and four-way emergency flashers.
- ✓ Turn on the parking, clearance, side-marker, and identification lights.
- ✓ Turn on the right turn signal and start the walk-around inspection.

General:

- Walk-around and inspect.
- Clean all lights, reflectors, and glass as you go along.

Left Front Side:

- ✓ Check the driver's door glass to make sure it is clean and not damaged.
- ✓ Check door latches or locks to ensure they work properly.

- ✓ Check the Left front wheel for:
 - The condition of the wheel and rim. Look for bent flanges, missing, bent, and/or broken studs, clamps, lugs, or any signs of misalignment.
 - The condition of the tire. Check to see the tire is properly inflated, valve stem and cap are OK, tire has no serious cuts, bulges, or tread wear.
 - Use wrench to test rust-streaked lug nuts which is an indication they are loose.
 - Check hub oil level if the vehicle is equipped with a sight glass and for leaks.

Left Front Suspension:

- ✓ Check the condition of the springs, spring hangers, shackles, and U-bolts.
- ✓ Check the shock absorber condition.

Left front brake:

- ✓ Check the condition of brake drum or rotor.
- ✓ Check the condition of the brake linings or pads.
- ✓ Check the condition of the air brake chamber, slack adjuster and connections.
- ✓ Check the condition of the air brake hoses or hydraulic lines.

Front:

- ✓ Check the condition of front axle.
- ✓ Check the condition of steering system:
 - Check for loose, worn, bent, damaged or missing parts.

- Grab the steering mechanism to test for looseness.

✓ Check the condition of windshield:

- Check for damage and clean if dirty.
- Check windshield wiper arms for proper spring tension.
- Check wiper blades for damage, "stiff" rubber, and secure mounting.

✓ Check lights and reflectors:

- Check to see that parking, clearance, and identification lights are clean, operating, and the proper color (amber at front).
- Check to see that the reflectors are clean and the proper color (amber at front).
- Check to see that the right front turn signal light is clean, operating, and proper color (amber or white on signals facing forward).

Right Side:

✓ Right front: check all items as done on left front.

✓ Check to see that the primary and secondary safety cab locks are engaged (if cab is over engine design).

✓ Check right fuel tank(s):

- Check to see that the tank(s) is securely mounted, not damaged, or leaking.
- Check the fuel crossover line to see that it is secure, undamaged and not leaking.
- Check the Tank(s) visually to see if they contain enough fuel.

- Check the filler cap(s) to see they are present, secure and not leaking.

✓ Check the condition of all visible parts:

- Check the rear part of the engine for leaks.
- Check the transmission for leaks.
- Check the exhaust system to make sure it is secure, not leaking, not touching wires, fuel, or air lines.
- Check the frame and cross members for bends, cracks or damage.
- Check the air lines and electrical wiring to ensure they are secured against snagging, rubbing, wearing.
- Check the spare tire carrier or rack to ensure it is secure and not damaged (if so equipped).
- Check the spare tire and/or wheel to see that it is securely mounted in rack (if so equipped).
- Check the spare tire and wheel are adequate, proper size and properly inflated.

✓ Cargo securement (trucks):

- Check to see that the cargo is properly blocked, braced, tied, chained, etc.
- Check the header board to see that it is adequate and secure (if so equipped).
- Check to see that the side boards and stakes are strong enough, free of damage and properly set in place (if so equipped).

- Check the canvas or tarp (if required) to ensure it is properly secured to prevent tearing, billowing, or blocking of mirrors.
- If the load is oversize, check all of the required signs (flags, lamps, and reflectors) to see that they are safely and properly mounted and all required permits are in the driver's possession.
- Check the curbside cargo compartment doors to see that they are in good condition, closed, latched/locked and that the required security seals are in place.

Right Rear:

- ✓ Check the condition of the wheels and rims. Check to see that there are no bent flanges, missing, bent, or broken spacers, studs, clamps, or lugs.
- ✓ Check the condition of the tires. Check to see that they are properly inflated, make sure the valve stems and caps are OK, tires do not have any serious cuts, bulges, uneven or excessive tread wear, tires are not rubbing each other and there is nothing stuck between them.
- ✓ Check to see that the tires are the same type (i.e., not mixed radial and bias types).
- ✓ Check to see that the tires evenly matched (same sizes).
- ✓ Check to see that the wheel bearing/axle seals are not leaking.
- ✓ Check the suspension:
 - Check the condition of the spring(s), spring hangers, shackles, and U-bolts.
 - Check to see that the axle is secure.

- Check to see the powered axle(s) is not leaking lube (gear oil).
- Check the condition of the torque rod arms and bushings.
- Check the condition of shock absorber(s).
- If retractable axle equipped, check the condition of the lift mechanism. If air powered, check for leaks.
- Check the condition of the air ride components.

Brakes:

- ✓ Check the brake adjustment.
- ✓ Check the condition of the brake drum(s) or rotors.
- ✓ Check the condition of air line hoses or hydraulic lines. Look for any wear due to rubbing or damage.
- ✓ Check the Lights/reflectors/reflector tape:
 - Check the side-marker lights to make sure they are clean, operating, and the proper color (red at rear, others amber).
 - Check the side-marker reflectors to make sure they are clean and the proper color (red at rear, others amber, and none broken or missing).
 - Check the reflector tape to see that it is present, clean and affixed securely to the Vehicle.

Rear:

- ✓ Check the lights/reflectors/reflector tape:
 - Check to see that the rear clearance and identification lights are clean, operating, and the proper color (red at rear).
 - Check to see that the reflectors are present, clean and proper the color (red at rear).
 - Check to see that the reflector tape is present and affixed securely to the vehicle.
 - Check to see that the tail lights are clean, operating, and proper color (red at rear).
 - Check to see that the right rear turn signal is operating, and the proper color (red, yellow, or amber at rear).
- ✓ Check to see that the license plate(s) is present, clean, secured and has a current registration sticker affixed to it.
- ✓ Check to see that mud flaps/splash guards are present, not damaged, properly fastened, cover the width of the tire(s), not dragging on ground (10 inches of clearance above the roadway) or rubbing the tires.
- ✓ Check to see that the cargo is secure (trucks)
- ✓ Check to see that cargo is properly blocked, braced, tied, chained, etc.
- ✓ Check to see that tailboards are up and properly secured.
- ✓ Check to see that end gates are free of damage and properly secured in the stake pockets.
- ✓ Check to see that the canvas or tarp (if required) is properly secured to prevent tearing, billowing, or blocking of either the rearview mirrors or rear lights.

- ✓ If over-length, or over-width, check to make sure all signs and/or additional lights/flags are safely and properly mounted and all required permits are in the driver's possession.
- ✓ Check to see that the rear doors securely closed, latched/locked.

Left Side:

- ✓ Check all items on the left side the same way they were checked on the right side, plus:
 - Check the battery(s) if not mounted in engine compartment.
 - Check the battery box(s) to see that it is securely mounted to the vehicle.
 - Check to see that the battery box cover is secure.
 - Check the battery(s) to see that it is secured in the battery box.
 - Check the battery(s) to see that it is not damaged or leaking.
 - Check the fluid in the battery(s) to see that it is at the proper level (except the maintenance free type).
 - Check the cell caps to see that they are present and securely tightened (except the maintenance free type).
 - Check to see that the vents in the cell caps are free of foreign material (except the maintenance free type).

Step 6: Check Signal Lights

Get In and Turn Off Lights.

- ✓ Turn off all of the lights.
- ✓ Activate the stop lights by stepping on the brake pedal on a single vehicle and have a helper let you know if they are working. On a combination vehicle, you can pull the trailer hand brake (also known as the Trolley Valve or Johnson Bar) down and secure it and go to the rear of the vehicle to see if the lights are functioning properly, or step on the brake pedal and have a helper let you know if the lights are working.
- ✓ Turn on left turn signal lights. Get out of the vehicle and check the lights.
- ✓ Check the left front turn signal light to see that it is clean, operating and the proper color (amber or white on signals facing the front).
- ✓ Check the left rear turn signal light and both stop lights to see that they are clean, operating, and the proper color (red, yellow, or amber).

Get In Vehicle:

- ✓ Turn off the lights you do not need for driving.
- ✓ Check for all required papers (trip manifests, current vehicle registration, insurance papers, permits, etc).
- ✓ Secure all loose articles in the cab (they might interfere with the operation of the controls or hit you in a crash).
- ✓ Start the engine.

Step 7: Start the Engine and Check

Test for Hydraulic Leaks: If the vehicle has hydraulic brakes, pump the brake pedal three times, apply firm pressure to the pedal and hold it for five seconds. The pedal should not move. If it does, there may be a leak

or other problem in the brake system. Get it fixed before driving. If the vehicle has air brakes, do the checks described in Chapters 5 and 6 of this manual.

Brake System

Test Parking Brake(s):

Test the parking brake on **single vehicles** using the following method:

- ✓ Apply the parking brake.
- ✓ Place the vehicle in low gear.
- ✓ Drive forward slowly and pull gently against the brake.
- ✓ If the brake doesn't stop the vehicle from moving forward, it is faulty and must be fixed before you travel.

Test the parking brakes on **combination vehicles** using the following method:

- ✓ Apply the Parking brake (pull out) and release (push in) the Tractor Protection Valve.
- ✓ Place the vehicle in low gear.
- ✓ Drive forward slowly and pull gently against the brake.
- ✓ If the brake doesn't stop the vehicle from moving forward, it is faulty and must be fixed before you travel.
- ✓ Apply the Tractor Protection Valve (pull out) and release (push in) the parking brake.
- ✓ Place the vehicle in low gear.
- ✓ Drive forward slowly and pull gently against the brake.
- ✓ If the brake doesn't stop the vehicle from moving forward, it is faulty and must be fixed before you travel.

Test The Service Brake:

- ✓ Accelerate the vehicle to about five miles per hour.
- ✓ Push the brake pedal firmly.
- ✓ Check to see if the vehicle pulls to one side or the other. If the vehicle pulls to one side or the other when the brakes are activated, it could mean they are out of adjustment or be an indication of some other mechanical problem. You should have them checked out as soon as possible.
- ✓ Any unusual brake pedal “feel” or delayed stopping action should be checked out before you travel.

Special Note: In many truck/tractors equipped with air brakes, the Trailer Spring Brake Modulating Valve—also known as a Trolley Valve or “Johnson Bar” is a modulating valve used to apply the spring brakes on a trailer gradually.



The valve is activated by pulling down on a spring loaded handle usually located on the steering column or dashboard. It is spring loaded so the driver will have a feel for the braking action. The more he/she moves the control lever, the harder the spring brakes come on. The system allows drivers to activate and control the spring brakes if the service brakes fail. Drivers should test the system by releasing the parking brake(s); pulling the Trolley Valve handle all the way down, and gently pulling against the brake to make sure it will hold the vehicle.

If you find anything unsafe during the pre-trip inspection, get it fixed. Federal and state laws forbid operating an unsafe vehicle.

2.1.6 Inspection during a Trip

Check Vehicle Operation Regularly: You should check-

- ✓ Instruments.
- ✓ Air pressure gauge (if you have air brakes).
- ✓ Temperature gauges.
- ✓ Pressure gauges.
- ✓ Ammeter/voltmeter.
- ✓ Mirrors.
- ✓ Tires.
- ✓ Cargo, cargo covers and securing devices.

If you see, hear, smell, or feel anything that might mean trouble, check it out.

Safety Inspection: Drivers of trucks and truck tractors when transporting cargo must inspect the securement of the cargo within the first 50 miles of a trip and every 150 miles or every three hours (whichever comes first) after.

2.1.7 Post-trip Inspection and Report

If the motor carrier is required to have their drivers prepare a Driver Inspection Report by the Federal Motor Carrier Safety Regulations, you must prepare a written inspection report at the completion of each day's work on each vehicle operated. You must identify the vehicle you operated and list any defect or deficiency that would affect the safe operation of the vehicle and/or any towed unit (trailer(s) that would cause the equipment to suffer a mechanical breakdown. You must also prepare a written report if no equipment defect or deficiency is found. In all instances, you **must** sign the report. If there are two (2) drivers in the same vehicle, only one has to sign the report, providing both

drivers agree to the operational condition of the equipment.

The Driver's Inspection Report notifies the motor carrier of the condition of the equipment and identifies any defects or deficiencies found that would make the unit(s) unsafe or cause it to break down. Depending on the motor carrier's policy regarding the distribution of the inspection report, if possible, you should leave a copy of the inspection report in the vehicle for at least a day so it can be reviewed by the next driver.

Subsection 2.1

Test Your Knowledge

1. What is the most important reason for doing a vehicle inspection?
2. What things should you check during a trip?
3. Name some key steering system parts.
4. Name some suspension system defects.
5. What three kinds of emergency equipment must you have?
6. What is the minimum tread depth for front tires? For other tires?
7. Name some things you should check on the front of your vehicle during the walk-around inspection.
8. What should wheel bearing seals be checked for?
9. How many red reflective triangles should you carry?
10. How do you test hydraulic brakes for leaks?
11. Why put the starter switch key in your pocket during the pre-trip inspection?

These questions may be on your test. If you can't answer them all, re-read subsection 2.1.

2.2 BASIC CONTROL OF YOUR VEHICLE

To drive a vehicle safely, you must be able to control its speed and direction. Safe operation of a commercial vehicle requires skill in:

- Accelerating.
- Steering.
- Stopping.
- Backing safely.

Fasten your seatbelt when on the road, It's the Law!

Apply the parking brake when you leave your vehicle.

2.2.1 Accelerating

Don't roll back when you start. You may hit someone behind you. If you have a manual transmission vehicle, partly engage the clutch before you take your right foot off the brake. Put on the parking brake whenever necessary to keep from rolling back. Release the parking brake only when you have applied enough engine power to keep from rolling back. On a tractor-trailer equipped with a trailer brake hand valve, the hand valve can be applied to keep from rolling back.

Speed up smoothly and gradually so the vehicle does not jerk. Rough acceleration can cause mechanical damage and cargo to shift. When pulling a trailer, rough acceleration can also damage the coupling.

Speed up very gradually when traction is poor, as in rain or snow. If you use too much power, the drive wheels may spin and you could lose control. If the drive wheels begin to spin, take your foot off the accelerator.

2.2.2 Steering

Hold the steering wheel firmly with both hands. Your hands should be on opposite sides of the wheel. If you hit a curb or a pothole (chuckhole), have a tire go flat on the steering axle, run into a strong gust of wind or slick road conditions, the wheel could pull away from your hands unless you have a firm hold.

2.2.3 Stopping

Push the brake pedal down gradually. The amount of brake pressure you need to stop the vehicle will depend

on the speed of the vehicle and how quickly you need to stop. Control the pressure so the vehicle comes to a smooth safe stop. If you have a manual transmission, push the clutch in when the engine is close to idle.

2.2.4 Backing Safely

Because you cannot see everything behind your vehicle, backing is always dangerous. Avoid backing whenever you can. When you park, try to park so you will be able to pull forward when you leave. When you have to back, here are a few simple safety rules:

- Start in the proper position.
- Look at your path
- Use mirrors on both sides.
- Back slowly.
- Back and turn toward the driver's side whenever possible.
- Use a helper whenever possible.

These rules are discussed in turn below.

Start in the Proper Position: Put the vehicle in the best position to allow you to back safely. This position will depend on the type of backing to be done and the amount of room you have to maneuver.

Look at Your Path: Look at your line of travel before you begin. Get out and walk around the vehicle. Check your clearance to the sides and overhead both in and near the path your vehicle will take.

Use Mirrors on Both Sides: Check the outside mirrors on both sides frequently. Get out of the vehicle and check your path if you are unsure.

Back Slowly: Always back as slowly as possible. Use the lowest reverse gear so you can more easily correct any steering errors and stop quickly if necessary.

Back and Turn toward the Driver's Side: Back to the driver's side so you can see better. Backing toward the right side is very dangerous because you can't see as well. If you back and turn toward the driver's side, you can watch the rear of your vehicle by looking out the side window. Use driver-side backing even if it means

going around the block to put your vehicle in this position. The added safety is worth it.

Use a Helper: Use a helper when you can. There are blind spots you can't see and vehicles and pedestrians can move into your path without you knowing they are there. That's why a helper is important. The helper should stand near the back of your vehicle where you can see him/her. Before you begin backing, work out a set of hand signals that you both understand. Agree on a signal for "stop."

2.3 SHIFTING GEARS

Correctly shifting gears (right gear – right speed) at the appropriate time is extremely important. If you can't get your vehicle into the right gear while driving under various conditions, you will have less control and become a hazard to other traffic.

2.3.1 Manual Transmissions

Basic Method for Shifting Up: Most heavy vehicles with manual transmissions require double clutching to change gears. This is the basic method:

- Release the accelerator, push in clutch and shift to neutral at the same time.
- Release the clutch.
- Let engine and gears slow down to the rpm required for the next gear (this takes practice).
- Push in the clutch and shift to the higher gear at the same time.
- Release the clutch and press the accelerator at the same time.

Shifting gears using double clutching requires practice. If you remain too long in neutral, you may have difficulty putting the vehicle into the next gear. If this happens, don't try to force it. Return to neutral, release the clutch, increase engine speed to match road speed, and try again.

Knowing When to Shift Up: There are two ways of knowing when to shift:

1. **Use Engine Speed (rpm):** Study the driver's manual for your vehicle and learn the operating

rpm range. Watch your tachometer and shift up when your engine reaches the top of the range. (Some newer vehicles use “progressive” shifting: the rpm at which you shift becomes higher as you move up in the gears). Find out what’s right for the vehicle you will operate.

2. **Use Road Speed (mph):** Learn the speed range for each gear. With this information you can use the speedometer to know when to shift up.

With either method, you will eventually learn with experience and practice to use engine sounds to shift.

Basic Procedures for Shifting Down:

- Release accelerator, push in the clutch, and shift to neutral at the same time.
- Release the clutch.
- Press the accelerator, increase engine and gear speed to the rpm required for the lower gear.
- Push in the clutch and shift to the lower gear at the same time.
- Release the clutch and press the accelerator at the same time.
- Down-shifting, like up-shifting, requires knowing when to shift. Use the tachometer, speedometer, or a combination of the both to shift the gears smoothly.

Special conditions where you should downshift include the following:

Before starting down a hill: Make sure you are in a low enough gear. This will usually be a lower gear than the gear required when climbing the same hill. Slow the vehicle down and shift down to a gear that will provide you with a safe speed that you can control without using the brakes excessively. Otherwise, prolonged use of the brakes can cause them to overheat and lose their braking power.

Before Entering a Curve: Slow the vehicle down to a safe speed and downshift to the right gear before entering the curve. This lets you use some power through the curve to help the vehicle be more stable

while turning. It also allows you to speed up as soon as you are out of the curve.

2.3.2 Multi-speed Rear Axles and Auxiliary Transmissions

Multi-speed rear axles and auxiliary transmissions are used on many vehicles to provide extra gears. You usually control them by a selector knob or switch on the gearshift lever of the main transmission. There are many different shift patterns. Learn the right way to shift gears in the vehicle you will drive.

2.3.3 Automatic Transmissions

Some vehicles have automatic transmissions. You can select a low range to get greater engine braking when going down grades. The lower ranges prevent the transmission from shifting up beyond the selected gear (unless the governor rpm is exceeded). It is very important to use this braking effect when going down grades.

2.3.4 Retarders (also known as “Jake Brakes”)

Some vehicles have “retarders.” Retarders help slow a vehicle down therefore, reducing the need for using your brakes. They reduce brake wear and give you another way to slow down. There are four basic types of retarders (exhaust, engine, hydraulic, and electric). All retarders can be turned on or off by the driver. On some vehicles the retarding power can be adjusted. When turned “on,” retarders apply their braking power (to the drive wheels only) whenever you let up on the accelerator pedal all the way. Because these devices can be noisy, be sure you know where their use is permitted. Many cities and towns have signage posted prohibiting the use of engine retarders in city limits.

Caution! When your drive wheels have poor traction, the retarder may cause them to skid. Therefore, you should turn the retarder off whenever the road is wet, icy, or snow covered.

Subsections 2.2 and 2.3

Test Your Knowledge

1. Why should you back toward the driver's side?
2. If stopped on a hill, how can you start moving without rolling back?

3. When backing, why is it important to use a helper?
4. What's the most important hand signal that you and the helper should agree upon?
5. What are the two special conditions where you should downshift?
6. When should you down-shift automatic transmissions?
7. Retarders keep you from skidding when the road is slippery. True or False?
8. What are the two ways to know when to shift?

These questions may be on the test. If you can't answer them all, re-read subsections 2.2 and 2.3.

2.4 SEEING

To be a safe driver you need to know what's going on all around your vehicle. Not looking properly is a major cause of accidents.

2.4.1 Seeing Ahead

All drivers look ahead; but many don't look far enough ahead.

Importance of Looking Far Enough Ahead: Because stopping or changing lanes can take a lot of distance, knowing what the traffic is doing on all sides of you is very important. You need to look well ahead to make sure you have room to make these moves safely.

How Far Ahead to Look: Most good drivers look at least 12 to 15 seconds ahead. That means looking ahead the distance you will travel in 12 to 15 seconds. At lower speeds, that's about one block, and at highway speeds it's about 1/4 of a mile. If you're not looking that far ahead, you may have to stop too quickly or make quick lane changes. Looking 12 to 15 seconds ahead doesn't mean not paying attention to things that are closer. Good drivers shift their attention back and forth, near and far. **Figure 2.6** illustrates how far to look ahead.



City Driving – 12-15 Seconds is About One Block



Figure 2.6
Open Highway – 12-15 Seconds is about 1/4 Mile

Look for Traffic: Look for vehicles coming onto the highway into your lane or turning. Watch for brake lights from slowing vehicles. By seeing these things far enough ahead, you can adjust your speed or change lanes if necessary to avoid a problem. If a traffic light has been green for a long time, it will probably change before you get there so start slowing down and be ready to stop. You can also watch the pedestrian cross walk sign for a clue to a pending signal change. If the sign is flashing or has turned to a solid red color, the light is about to change.

2.4.2 Seeing to the Sides and Rear

It's important to know what's going on behind and to the sides of your vehicle at all times. Check your mirrors regularly and even more often than normal in special situations (heavy traffic, etc.).

Mirror Adjustment: Mirror adjustment should be checked prior to the start of any trip and can only be

checked accurately when the trailer(s) are straight. You should check and adjust each mirror to show some part of the vehicle, because this will give you a reference point for judging the position of the other images.

Regular Mirror Checks: You need to make regular checks of your mirrors to be aware of traffic and to check your vehicle for potential equipment problems.

Traffic: Check your mirrors for vehicles on either side and in back of you. In an emergency, you may need to know whether you can make a quick lane change. Use your mirrors to spot overtaking vehicles. There are “blind spots” that your mirrors cannot show you; therefore, check your mirrors regularly to know where other vehicles are around you and to see if they move into your blind spots.

Check Your Vehicle: Use the mirrors to keep an eye on your tires and wheels. A low or flat tire or hot brakes will often emit smoke.

Check your Cargo: If you’re carrying open cargo, you can use the mirrors to check for loose straps, ropes, or chains. Watch for a flapping or ballooning tarp. Sometimes cargo can shift while underway.

Special Situations: Special situations require more than regular mirror checks. These are lane changes, turns, merges, and tight maneuvers.

Lane Changes: You need to check your mirrors to make sure no one is alongside you or about to pass you. Check your mirrors:

- ✓ Check before you change lanes to make sure there is enough room.
- ✓ Check after you have signaled to make sure no one has moved into your blind spot.
- ✓ Check right after you start the lane change to make sure your path is clear.
- ✓ Check after you complete the lane change.

Turns: In turns, check your mirrors to make sure the rear of your vehicle will not hit anything.

Merges: When merging, use your mirrors to make sure the gap in traffic is large enough for you to enter safely.

Tight Maneuvers: Any time you are driving in close quarters, check your mirrors often. Make sure you have enough clearance.

How to Use Mirrors: Use mirrors correctly by checking them quickly and understanding what you see.

- When you use your mirrors while driving on the road, check quickly. Look back and forth between the mirrors and the road ahead. Don’t focus on the mirrors for too long; otherwise you will travel quite a distance without knowing what’s happening ahead.
- Many large vehicles have curved (convex, “fisheye,” “spot,” “bug eye”) mirrors that show a wider area than flat mirrors. These mirrors are often helpful, but remember, everything appears smaller in a convex mirror than it would if you were looking at it directly. Things also seem farther away than they really are. It’s important to realize this and to allow for it. **Figure 2.7** shows the field of vision using a convex mirror:

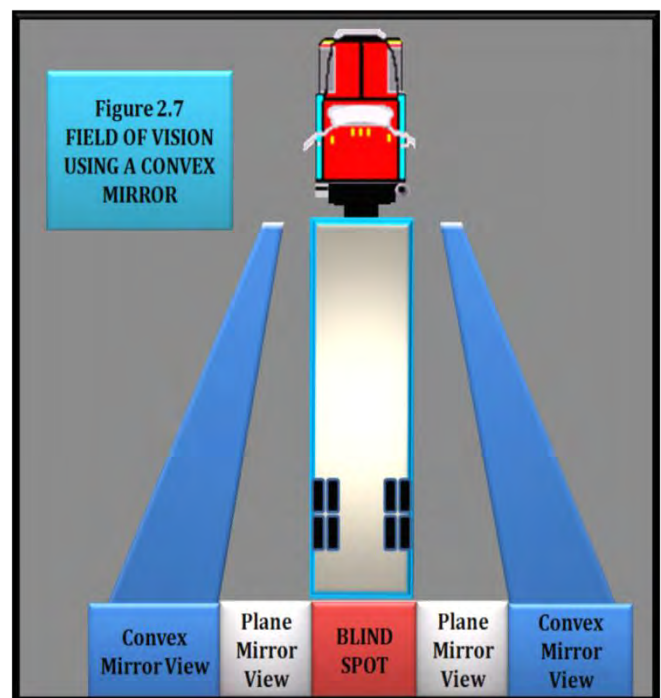

2.5 COMMUNICATING

2.5.1 Signal Your Intentions

Other drivers can't know what you are going to do until you tell them. Signaling what you intend to do is important for safety. The following are some general rules for signaling:

Turns: There are three good rules for using turn signals-

1. **Signal early:** Signal well before you turn, because it is the best way to keep others from trying to pass you.
2. **Signal continuously:** You need both hands on the wheel to turn safely, so don't cancel the signal until you have completed the turn.
3. **Cancel your signal:** Don't forget to turn off your turn signal after you've completed the turn. Even if you have self-canceling turn signals, make sure the signal has cancelled after the turn.

Lane Changes: Put your turn signal on before changing lanes and change lanes slowly and smoothly. That way a driver you didn't see may have a chance to honk the horn or avoid your vehicle.

When Slowing Down: Warn drivers behind you when you see you'll need to slow down unexpectedly. A few light taps on the brake pedal enough to flash the brake lights should warn following drivers. Use the four-way emergency flashers for times when you are driving very slowly or are stopped. Warn other drivers in any of the following situations:

- **Trouble Ahead:** The size of your vehicle may make it hard for drivers behind you to see hazards ahead. If you see a hazard that will require slowing down, warn the drivers behind by flashing your brake lights.
- **Tight Turns:** Most car drivers don't know how slowly you have to go to make a tight turn in a large vehicle. Give drivers behind you warning by braking early and slowing gradually.
- **Stopping on the Road:** Truck and bus drivers sometimes stop in the roadway to unload cargo or passengers, or to stop at a railroad

crossing. Warn following drivers by flashing your brake lights and don't stop suddenly.

- **Driving Slowly:** Drivers often do not realize how fast they are catching up to a slow vehicle until they are very close. If you must drive slowly (i.e., climbing a hill), alert following drivers by turning on your emergency flashers if it is legal. (Laws regarding the use of flashers differ from one state to another; therefore, check the laws of the states where you will drive).

Don't Direct Traffic: Some drivers try to help out others by signaling when it is safe to pass. You should not do this, because you could cause an accident and be held responsible which could cost you many thousands of dollars.

2.5.2 Communicating Your Presence

Other drivers may not notice your vehicle even when it's in plain sight. To help prevent accidents, let them know you're there.

When Passing: Whenever you are about to pass a vehicle, pedestrian, or bicyclist, assume they don't see you and could suddenly move in front of you. When it is legal, tap the horn lightly or, at night, flash your lights from low to high beam and back. Drive carefully enough to avoid a crash even if they don't see or hear you.

When It Is Hard to See: At dawn, dusk, in rain, snow or fog, you need to make yourself easier to see. If you are having trouble seeing other vehicles, other drivers will have trouble seeing you. Turn on your lights. Use the headlights and not just the identification or clearance lights. Use the low beams, because high beams can bother people in the daytime as well as at night.

When Parked at the Side of the Road: When you pull off the road and stop, be sure to turn on the four-way emergency flashers. This is especially important at night. Don't trust the taillights alone to give enough warning to other drivers. Drivers have crashed into the rear of a parked vehicle, because they thought it was moving normally.

If you must stop on a road or the shoulder of any road, you must put out your emergency warning devices within ten minutes. Depending on the type of road you

are traveling (one-way, two-lane or multi-lane) place your warning devices at the following locations:

If you must stop on or by a one-way or divided highway, place the warning devices 10 feet, 100 feet, and 200 feet toward the approaching traffic (See Figure 2.8).

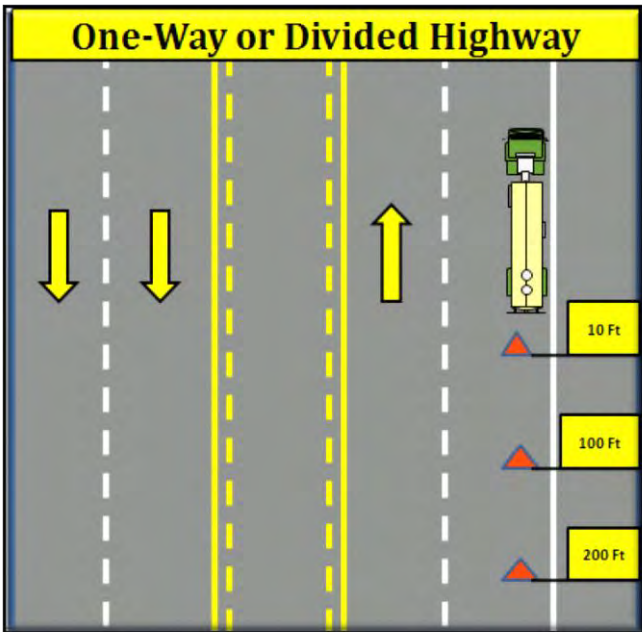

Figure 2.8

If you stop on a two-lane road carrying traffic in both directions or on an undivided highway, place the warning devices within 10 feet of the front or rear corners to mark the location of the vehicle, and 100 feet behind and ahead of the vehicle. Place the devices on the shoulder of the road or in the lane where your vehicle is stopped (See Figure 2.9).

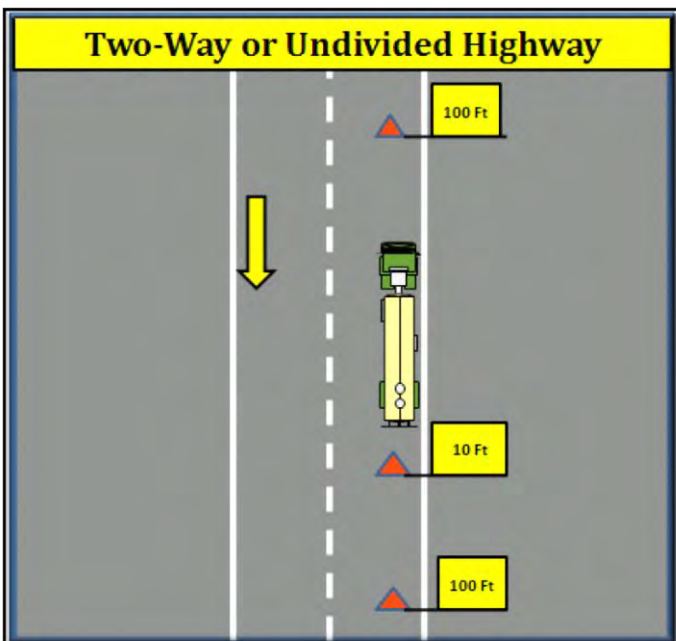

Figure 2.9

Back beyond any hill, curve, or other obstruction that prevents other drivers from seeing the vehicle within 500 feet. If line of sight view is obstructed due to a hill or curve, move the rear-most triangle to a point back down the road so ample warning is provided to other drivers (See Figure 2.10).

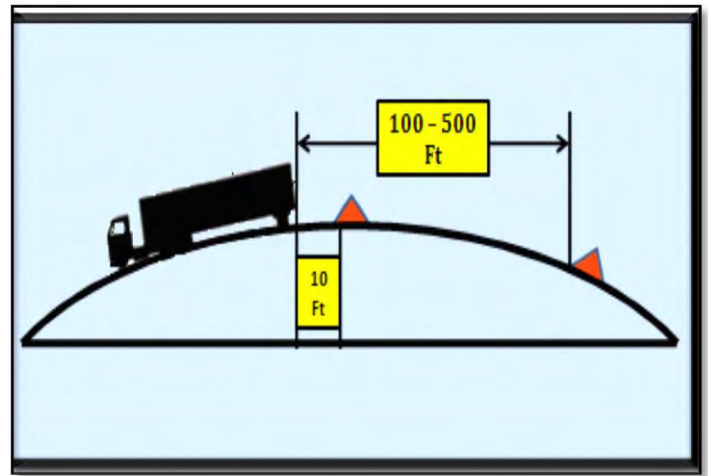
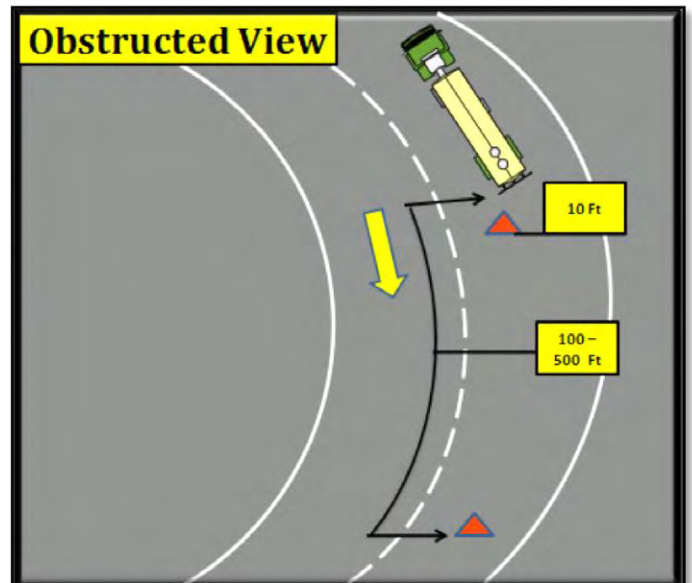

Figure 2.10

When putting out the triangles, hold them between yourself and the oncoming traffic for your own safety. This will allow other drivers to see you. If available, also put on a reflective safety vest to make you more visible.

Use Your Horn When Needed: Your horn can let others know you're there, and it can help to avoid a crash. However, it also can startle others and could be dangerous when used unnecessarily, so exercise good judgment.



2.6 CONTROLLING SPEED

Driving too fast is a major cause of fatal crashes. You must adjust your speed depending on the driving conditions you encounter while traveling. These conditions include: traction, curves, visibility, traffic, and hills.

2.6.1 Stopping Distance

Perception Distance + Reaction Distance + Braking Distance = Total Stopping Distance

Perception Distance: This is the distance your vehicle travels from the time your eyes see a hazard until your brain recognizes it. The perception time for an alert driver is about 1 3/4 seconds. At 55 mph, you will travel 142 feet.

Reaction Distance: The distance traveled from the time your brain tells your foot to move from the accelerator until your foot is actually pushing down on the brake pedal. The average driver has a reaction time of 3/4 of a second to 1 second. At 55 mph this accounts for 61 feet.

Braking Distance: The distance it takes to stop once the brakes are applied. At 55 mph, on dry pavement with good brakes, it can take a heavy vehicle about 216 feet.

Total Stopping Distance: At 55 mph, it will take about six seconds to stop and your vehicle will have traveled about 419 feet (the equivalent in length of 1 1/2 football fields).

The Effect of Speed on Stopping Distance: Whenever you double your speed, it takes about four times as much distance to stop, and your vehicle will have four times the destructive power if it crashes. Triple the speed from 20 to 60 mph and the impact and braking distance is 9 times greater. At 60 mph, your stopping distance is greater than the length of a football field (over 300 feet), and the impact and braking distance are 16 times greater than at 20 mph. High speeds greatly increase the severity of crashes and stopping distances. By slowing down, you can reduce braking distance (See Figure 2.11).

The Effect of Vehicle Weight on Stopping Distance: The heavier the vehicle, the more work the brakes must do to stop it and the more heat they absorb, but the brakes, tires, springs, and shock absorbers on heavy vehicles are designed to work best when the vehicle is fully loaded. Empty trucks require greater stopping distances because an empty vehicle has less traction.

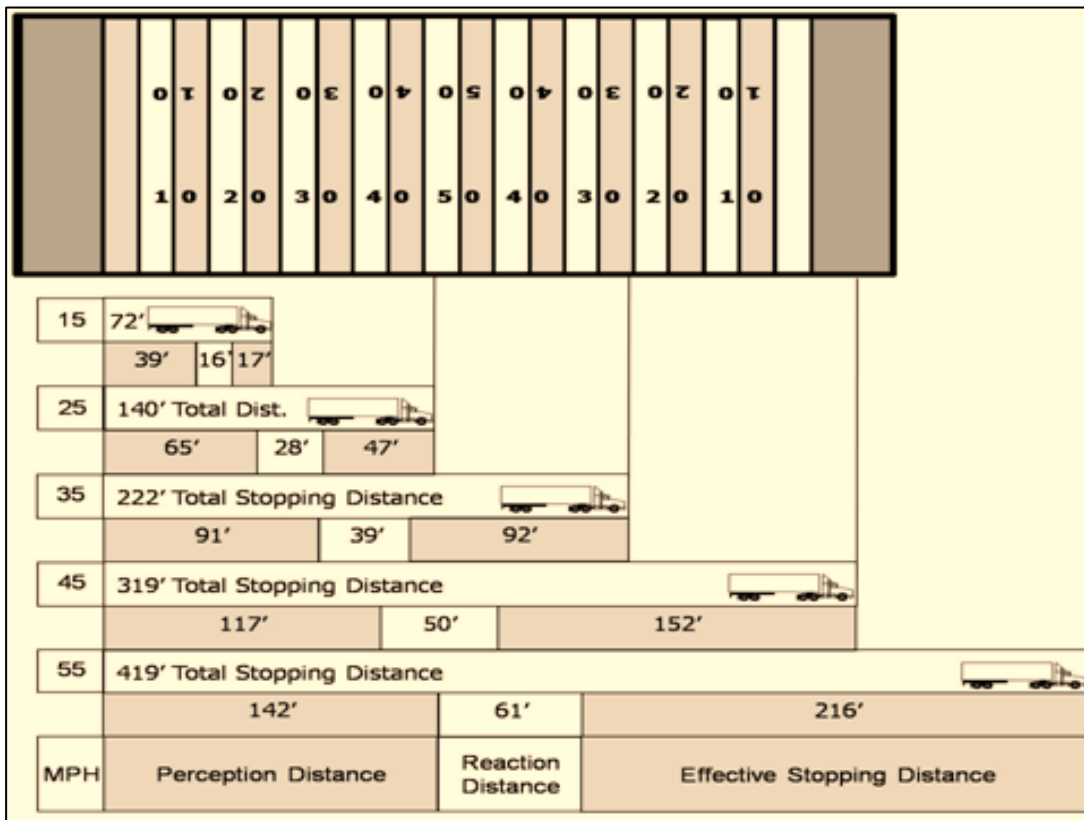

Figure 2.11

2.6.2 Matching Speed to the Road Surface

You can't steer or stop a vehicle unless you have traction. Traction is friction between the tires and the road. There are some road conditions that reduce traction and call for lower speeds.

Slippery Surfaces: It will take longer to stop, and it will be harder to turn without skidding, when the road is slippery. Wet roads can double the stopping distance. You must drive slower to be able to stop in the same distance as on a dry road. Reduce speed by about one-third (i.e., slow from 55 to about 35 mph) on a wet road. On packed snow, reduce speed by a half, or more. If the surface is icy, reduce speed to a crawl and stop driving as soon as you can safely do so.

Identifying Slippery Surfaces: Sometimes it's hard to know if the road is slick. Here are some signs of slippery roads:

- **Shaded Areas:** Shady parts of the road will remain icy and slippery long after open areas have melted.
- **Bridges:** When the temperature drops, bridges will freeze before the road will. Be especially careful when the temperature is close to 32° Fahrenheit.
- **Melting Ice:** Slight melting will make ice wet. Wet ice is much more slippery than ice that is not wet.
- **Black Ice:** Black ice is a thin layer that is clear enough that you can see the road underneath it. It makes the road look wet. Any time the temperature is below freezing and the road looks wet, watch out for black ice.
- **Road Spray:** If your tires were throwing up road spray, and they stop, that is a sign the road surface may be freezing up.
- **Vehicle Icing:** An easy way to check for ice is to open the window and feel the front of the mirror, mirror support, or antenna. If there's ice on these items, the road surface is probably starting to ice up as well.
- **Just After Rain Begins:** Right after it starts to rain, the water mixes with oil left on the road by

vehicles. This makes the road very slippery. If the rain continues, it will wash the oil away.

- **Hydroplaning:** In some weather, water or slush collects on the road. When this happens, your vehicle can hydroplane. Hydroplaning is like water skiing - the tires lose their contact with the road and have little or no traction. You may not be able to steer or brake. You can regain control by releasing the accelerator and pushing in the clutch. This will slow your vehicle and let the wheels turn freely. If the vehicle is hydroplaning, do not use the brakes to slow down. If the drive wheels start to skid, push in the clutch to let them turn freely.

It does not take a lot of water to cause hydroplaning. Hydroplaning can occur at speeds as low as 30 mph if there is a lot of water. Hydroplaning is more likely if tire pressure is low, or the tread is worn. (The grooves in a tire carry away the water and if they aren't deep enough, they don't work well.)

Road surfaces where water can collect can create conditions that cause a vehicle to hydroplane. Watch for clear reflections, tire splashes, and raindrops on the road. These are indications of standing water.

2.6.3 Speed and Curves

Drivers must adjust their speed for curves in the road. If you take a curve too fast, two things can happen, 1) the tires can lose their traction and continue straight ahead, so you skid off the road, or 2) the tires may keep their traction and the vehicle rolls over. Tests have shown that trucks with a high center of gravity can roll over at the posted speed limit for a curve.

Slow to a safe speed before you enter a curve. Braking in a curve is dangerous because it is easier to lock the wheels and cause a skid. Slow down as needed and don't ever exceed the posted speed limit for the curve. Be in a gear that will let you accelerate slightly in the curve, because this will help you keep control.

2.6.4 Speed and Distance Ahead

You should always be able to stop within the distance you can see ahead. Fog, rain, or other conditions may require that you slow down to be able to stop in the distance you can see. At night, you can't see as far with

low beams as you can with high beams, so when you must use low beams, slow down.

2.6.5 Speed and Traffic Flow

When you're driving in heavy traffic, the safest speed is the speed of the other vehicles. Vehicles going the same direction at the same speed are not likely to run into one another. In many states, speed limits are lower for trucks and buses than for cars (It can vary as much as 15 mph). Use extra caution when you change lanes or pass on these roadways. Drive at the speed of the traffic if you can without going at an illegal or unsafe speed. Always keep a safe following distance.

The main reason drivers exceed the speed limit is to save time, but anyone trying to drive faster than the speed of traffic will not be able to save much time at all and increase their risk of being involved in an accident and/or get a costly speeding ticket. The risks involved are not worth it. If you go faster than the speed of other traffic, you'll not only increase your chances of being involved in an accident, but you will also find the stress and increased concentration of negotiating traffic more physically tiring. Fatigue increases the chance of a crash. Going with the flow of traffic is safer and easier.

2.6.6 Speed on Downgrades

Your vehicle's speed will increase on downgrades because of gravity. Your most important objective is to select and maintain a speed that is not too fast for the:

- Total weight of the vehicle and cargo;
- Length of the grade;
- Steepness of the grade;
- Road conditions, and
- Weather.

If a speed limit is posted, or there is a sign indicating "Maximum Safe Speed," never exceed the speed shown. Also, look for and heed warning signs indicating the length and steepness of the grade.

You must use the braking effect of the engine as the principal way of controlling your speed on downgrades. The braking effect of the engine is greatest when it is

near the governed rpm setting and the transmission is in the lower gears. Save your brakes so you will be able to slow or stop as required by road and traffic conditions. Shift your transmission to a low gear before starting down the grade and use the proper braking techniques.

Please read carefully the section on going down long, steep downgrades safely in the "Mountain Driving," Section 2.16.

2.6.7 Roadway Work Zones

Speeding traffic is the number one cause of injury and death in roadway work zones. Observe the posted speed limits at all times when approaching and driving through a work zone. Watch your speedometer, and don't allow your speed to creep up as you drive through long sections of road construction. Decrease your speed for adverse weather or road conditions and even further when a worker is close to the roadway.

Subsections 2.4, 2.5, and 2.6

Test Your Knowledge

1. How far ahead does the manual say you should look while driving?
2. What are the two main things to look for ahead?
3. What's your most important way to see the sides and rear of your vehicle?
4. What does "communicating" mean in safe driving?
5. Where should warning devices be placed when stopped on a divided highway?
6. What three things add up to total stopping distance?
7. If you go twice as fast, will your stopping distance increase by two or four times?
8. Empty trucks have the best braking. True or False?
9. What is hydroplaning?
10. What is "black ice"?

These questions may be on the test. If you can't answer them all, re-read subsections 2.4, 2.5, and 2.6.

2.7 MANAGING SPACE

To be a safe driver, you need space all around your vehicle. When things go wrong, space gives you the time to think and to take action. To have space available when something goes wrong, you need to manage space. While this is true for all drivers, it is very important for large vehicles, because they take up more space and require more room for stopping and turning.

2.7.1 Space Ahead

Of all the space around your vehicle, it is the area ahead of the vehicle - the space you're driving into - that is the most important.

The Need for Space Ahead: You need space ahead in case you must suddenly stop. According to accident reports, the vehicle that trucks and buses most often run into is the one in front of them. The most frequent cause is following too closely. Remember, if the vehicle ahead of you is smaller than yours, it can probably stop faster than you can and you may crash into it if you are following too closely.

How Much Space: How much space should you keep in front of you? One good rule says you need at least one second for each 10 feet of vehicle length at speeds below 40 mph. For example, if you are driving a 40-foot vehicle, you should leave four seconds between you and the vehicle ahead. In a 60-foot vehicle, you'll need six seconds. At greater speeds, you must add one second for safety. Over 40 mph, you'd need five seconds for a 40-foot vehicle and seven seconds for a 60-foot vehicle (**See Figure 2.11**).

To know how much space you have, wait until the vehicle ahead passes a shadow on the road, a pavement marking, or some other clear landmark, then count off the seconds (i.e., one thousand one, one thousand two, and so on) until you reach the same spot. Compare your count with the rule of one second for every ten feet of length. If you are driving a 40-foot truck and only counted up to two seconds, you're too close. Drop back a little and count again until you have 4 seconds of following distance (or 5 seconds, if you're going over 40 mph). After a little practice, you will know how far back you should be. **Remember to add one second for speeds above 40 mph**. Also remember, that when the road is slippery, you need **much more space** to stop.

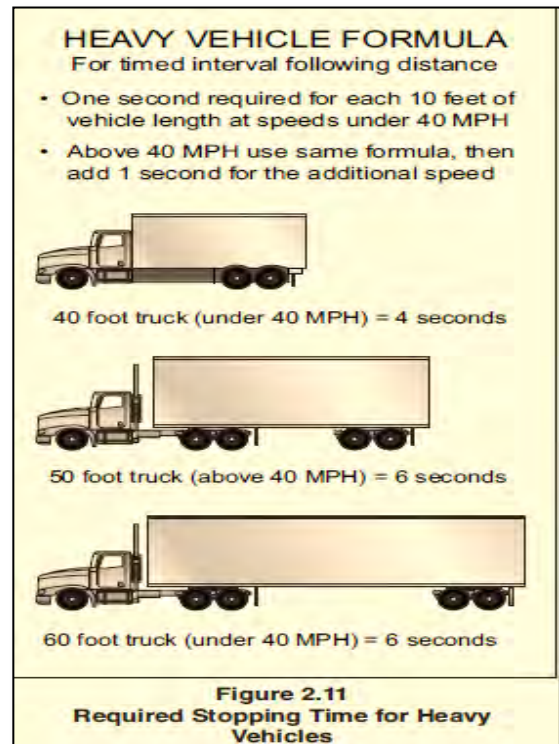

2.7.2 Space Behind

You can't stop others from following you too closely, but there are things you can do to make it safer.

Stay to the Right: Heavy vehicles are often tailgated when they can't keep up with the speed of other traffic. This often happens when you're going uphill. If a heavy load is slowing you down, stay in the right lane if you can. Going uphill, you should not pass another slow vehicle unless you can get around quickly and safely.

Dealing with Tailgaters Safely: In a large vehicle, it can be difficult to see vehicles close behind you. You may be tailgated in the following circumstances:

- When you are traveling slowly: Drivers trapped behind slow vehicles often follow too closely.
- In bad weather: Many car drivers follow large vehicles closely during bad weather, especially when it is hard to see the road ahead.

If you find yourself being tailgated, here are some things you can do to reduce the chances of a crash.

- Avoid quick changes. If you have to slow down or turn, signal early, and reduce speed very gradually.

- Increase your following distance. Opening up room in front of you will help you to avoid having to make sudden speed or direction changes. It also makes it easier for the tailgater to get around you.
- Don't speed up. It's safer to be tailgated at a low speed than a high speed.
- Avoid tricks. Don't turn on your taillights or flash your brake lights. Follow the suggestions above.

2.7.3 Space to the Sides

Commercial vehicles are often wide and take up most of a lane. Safe drivers will manage what little space they have. You can do this by keeping your vehicle centered in your lane and avoid driving alongside others.

Staying Centered in a Lane: You need to keep your vehicle centered in the lane to keep a safe clearance on either side. If your vehicle is wide, you have little room to spare.

Traveling Next to Others: There are two dangers in traveling alongside other vehicles:

1. Another driver may change lanes suddenly and turn into you.
2. You may be trapped when you need to change lanes.

Find an open spot where you are not near other traffic:

When traffic is heavy, it may be hard to find an open spot. If you must travel near other vehicles, try to keep as much space as possible between you and them. Also, drop back or pull forward so that you are sure the other driver can see you.

Strong Winds: Strong winds make it difficult to stay in your lane. The problem is usually worse for lighter vehicles. This problem can be especially bad coming out of tunnels, going over bridges and driving through mountain passes. Don't drive alongside others if you can avoid it.

2.7.4 Space Overhead

Hitting overhead objects is a danger. Make sure you always have the appropriate overhead clearance for

your vehicle. This is especially important when towing van type trailers and flatbeds with high loads while traveling on roadways with bridges and/or overpasses that have restricted height limits.

- Don't assume that the heights posted at bridges and overpasses are correct. Re-paving or packed snow may have reduced the clearances since the heights were posted.
- The weight of a cargo van changes its height. An empty van is higher than a loaded one. Because you were able to go under a bridge when you were loaded, does not mean that you can do it when you are empty.
- If you doubt you have safe space to pass under an object, go slowly. If you aren't sure you can make it, take another route. Warnings are often posted on low bridges or underpasses; however, sometimes they are not.
- Some roads can cause a vehicle to tilt. There can be a problem clearing objects along the edge of the road, such as signs, trees, or bridge supports. Where this is a problem, drive a little closer to the center of the road.
- Before you back into an area, get out and check for overhanging objects such as trees, branches, electric wires or a building's roof. It's easy to miss seeing them while you are backing (Also check for other hazards at the same time).

2.7.5 Space Below

Many drivers forget about the space under their vehicles. That space can be very small when a vehicle is heavily loaded. This is often a problem on dirt roads and in unpaved yards. Don't take a chance on getting hung up. Drainage channels across roads can cause the ends of some vehicles to drag. Cross such depressions carefully.



Railroad tracks can also cause problems, particularly when pulling trailers with a low underneath clearance. Don't take a chance on getting hung up halfway across the tracks.

2.7.6 Space for Turns

The space around a truck or bus is important in turns. Because of the wide turning and off-tracking characteristics of longer vehicles, large vehicles can hit other vehicles or objects during turns (especially the right turn).

Right Turns: Here are some rules to help prevent right-turn crashes:

Turn slowly to give yourself and others more time to avoid problems. If you are driving a truck or bus that cannot make the right turn without swinging into another lane, turn wide as you complete the turn when possible. Keep the rear of your vehicle close to the curb, because this will stop other drivers from passing you on the right. (See Figure 2-12a)



Figure 2-12a Example of a "Button Hook" right turn

Unless you can't avoid it, (sharp turn onto a narrow roadway) don't turn wide to the left into oncoming traffic as you start the turn. A following driver may think you are turning left and try to pass you on the right, and you may crash into the other vehicle as you complete your turn.



If you must cross into the oncoming lane to make a turn, watch out for vehicles coming toward you. Give them room to go by or to stop; however, don't back up for them, because you might hit someone behind you (See Figure 2.12)

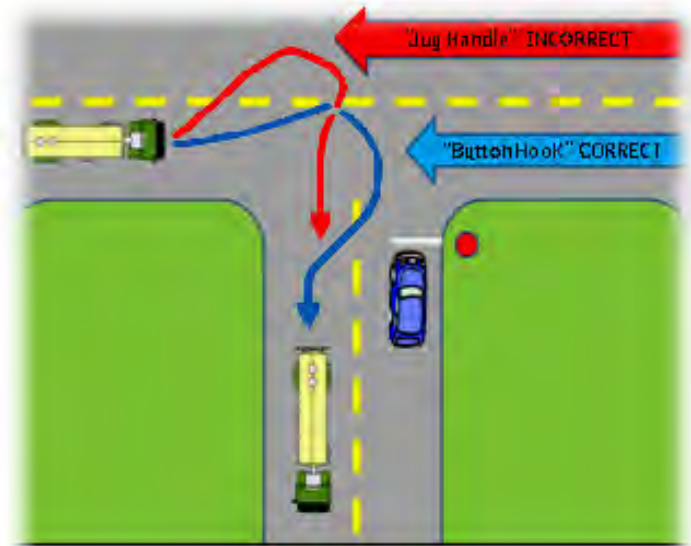

Figure 2.12 Correct Execution of Right Turns

Left Turns: On a left turn, make sure you have reached the center of the intersection before you start the left turn. If you turn too soon, the left side of your vehicle may hit another vehicle, obstacle or pedestrian because of the off-tracking characteristics of longer vehicles. **If there are two turning lanes, always take the right turn lane.** Don't start in the inside lane because you may have to swing right to make the turn and drivers on your left can more readily be seen (See Figure 2.13).

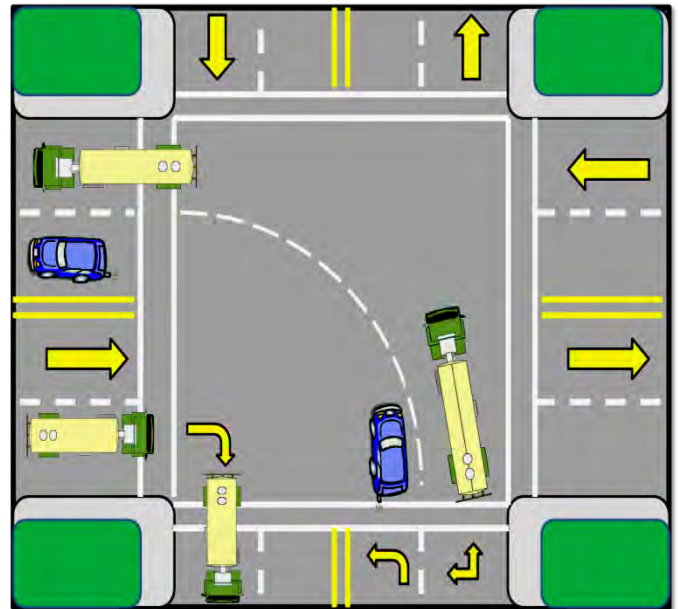

Figure 2.13 Correct Execution of Left Turns

2.7.7 Space Needed to Cross or Enter Traffic

Be aware of the size and weight of your vehicle when you cross or enter traffic. Here are some important things to keep in mind:

- Because of slow acceleration and the space large vehicles require, you may need a much larger gap to enter traffic than you would in a car.
- Acceleration varies with the load. Allow more room if your vehicle is heavily loaded.
- Before you start across a road, make sure you can get all the way across before traffic reaches you.

2.8 SEEING HAZARDS

2.8.1 Importance of Seeing Hazards

What Is a Hazard: A hazard is any road condition or other road user (driver, bicyclist, pedestrian) that is a possible danger. For example, a car in front of you is headed toward the freeway exit, but his brake lights come on and he begins braking hard. This could mean that the driver is uncertain about taking the off ramp, and he might suddenly return to the highway. This car is a hazard. If the driver of the car cuts in front of you, it is no longer just a hazard, it is an emergency.

Seeing Hazards Lets You Be Prepared: You will have more time to act if you see hazards before they become emergencies. In the example above, you might make a lane change or slow down to prevent a crash if the car suddenly cuts in front of you. Seeing this hazard gives you time to check your mirrors and signal a lane change. Being prepared reduces the danger. A driver who did not see the hazard until the slow car pulled back on the highway in front of him would have to do something very suddenly. Sudden braking or a quick lane change is much more likely to lead to a crash.

Learning to See Hazards: There are often clues that will help you see hazards. The more you drive, the better you can learn to see hazards. This section will talk about hazards that you should be aware of.

2.8.2 Hazardous Roads

Slow down and be very careful if you see any of the following road hazards:

Work Zones: When people are working on the road, it is a hazard. There may be narrower lanes, sharp turns, or uneven surfaces. Other drivers are often distracted and drive unsafely. Workers and construction vehicles may get in the way. Drive slowly and carefully near work zones and, if necessary, use your four-way flashers or brake lights to warn drivers behind you.

Drop Off: Sometimes the pavement drops off sharply near the edge of the road. Driving too near the edge can tilt your vehicle toward the side of the road. This can cause the top of your vehicle to hit roadside objects (signs, tree limbs). Also, it can be hard to steer as you cross the drop off (going off the road or coming back on), and may cause your vehicle to rollover.

Foreign Object: Things that have fallen on the road can be hazards. They can damage your tires, wheel rims and electrical and brake lines. Objects can also be caught between dual tires and cause severe damage to your vehicle or other drivers. Some obstacles that appear to be harmless can be very dangerous. For example, cardboard boxes may be empty, but they may also contain some solid or heavy material capable of causing damage. The same is true of paper and cloth sacks. One of the most common hazards on the road is rubber from a blown tire (also known as a gator) that, if run over, can cause extensive damage to brake and/or hydraulic lines. It is important to remain alert for objects of all sorts, so you can see them early enough to avoid them without making sudden, unsafe moves. If you hit an object on the road, stop as soon as you can and inspect your vehicle for damage.

Off Ramps/On Ramps: Freeway and turnpike exits can be particularly dangerous for commercial vehicles. Off ramps and on ramps often have speed limit signs posted. Remember, these speeds may be safe for automobiles, but may not be safe for larger vehicles or heavily loaded vehicles. Exits that go downhill and turn at the same time can be especially dangerous. The downgrade makes it difficult to reduce speed and braking and turning at the same time can be a dangerous practice. Make sure you are going slowly enough before you get on the curved part of an off ramp or on ramp.

Approaching Stationary Police / Emergency Vehicles:

Generally, it is a good safe practice to slow down and use caution when approaching stationary emergency vehicles and personnel engaged in activities on the road. Some states (including Idaho) have enacted specific laws addressing this issue, and the specific conduct and responsibility they expect of the driver. Commercial vehicles are inherently a risk factor when approaching a stationary vehicle of any kind due to their size, weight, stopping distance and maneuverability limitations.

In Idaho, if you are approaching a stationary police and/or emergency vehicle displaying flashing lights, you are required to:

- On a highway with two (2) or more lanes carrying traffic in the same direction (interstate or divided highway):
 1. Immediately reduce your speed to below the posted speed limit.
 2. Proceed with extreme caution.
 3. Change lanes as soon as it is possible to do so safely.
 4. Remain alert for emergency personnel directing traffic and entering and/or exiting the area.
- On a highway with one (1) lane for each direction of travel:
 1. Immediately reduce your speed to below the posted speed limit.
 2. Proceed with extreme caution.
 3. Maintain a safe speed for the road, weather and traffic conditions until completely past the stationary emergency vehicle(s).
 4. If safe to do so, change lanes until you are completely past the stationary emergency vehicle(s).
 5. Remain alert for emergency personnel directing traffic and entering and/or exiting the area.

2.8.3 Drivers Who May Pose a Hazard

In order to protect yourself and others, you must know when other drivers may do something hazardous. Some clues to this type of hazard are discussed below.

Blocked Vision: Drivers who cannot see clearly pose a very dangerous hazard. Be alert for vehicles with vision limitations. Vans, loaded station wagons, and cars with the rear window blocked are examples. Rental trucks should be watched carefully, because their drivers are often not used to the limited vision they have to the sides and rear of the truck. In winter, vehicles with frosted, ice-covered, or snow-covered windows are hazards.

Vehicles May Be Partly Hidden By Blind Intersections Or Alleys:

If you can only see the rear or front end of a vehicle but not the driver, then he/she can't see you. Be alert because he/she may back out or enter into your lane. Always be prepared to stop.

Delivery Trucks: Packages or vehicle doors often block the driver's vision. Drivers of step vans, postal vehicles, and local delivery vehicles often are in a hurry and may suddenly step out of their vehicle or drive their vehicle into the traffic lane.

Parked Vehicles: This is especially true when people start to get out of them. They may also suddenly start up and drive into your way without looking. Watch for movement inside the vehicle or movement of the vehicle itself that shows people are inside. Watch for brake lights or backup lights, exhaust, and other clues that a driver is about to move.

Stopped Bus: Passengers may cross in front of or behind the bus, and they often can't see you.

Pedestrians and Bicyclists: Walkers, joggers, and bicyclists may be on the road with their back to the traffic, so they can't see you. Sometimes they wear portable stereos with headsets, so they can't hear you either. This can be dangerous. On rainy days, pedestrians may not see you because of hats or umbrellas. They may be hurrying to get out of the rain and may not pay attention to the traffic.

Distractions: People who are distracted are hazards. Watch for where they are looking. If they are looking elsewhere, they can't see you; however, still be alert

even when they are looking at you, because they may believe they have the right of way.

Children: Children tend to act quickly without checking traffic. Children playing with one another may not look for traffic and are a serious hazard.

Talkers: Drivers or pedestrians talking to one another may not be paying close attention to the traffic.

Workers: People working on or near the roadway can be a hazard. The work creates a distraction for other drivers and the workers themselves may not see you.

Ice Cream Trucks: Someone selling ice cream can be a hazard. Children may be nearby and may not see you.

Disabled Vehicles: Drivers changing a tire or fixing an engine often do not pay attention to the danger that roadway traffic is to them, so they are often careless. Passengers, children and animals may also be around the vehicle while it is being worked on and dart out in front of you before you can react. Jacked-up wheels or raised hoods are hazard clues.

Accidents: Accidents are particularly hazardous. People involved in the accident may not look for traffic, because they are upset, injured or on their cell phones. Passing drivers tend to look at the accident and cause traffic congestion problems by driving excessively slow. People often run across the road without looking. Vehicles may slow or stop suddenly.

Shoppers: People in and around shopping areas are often not watching traffic, because they are looking for stores or looking into store windows.

Confused Drivers: Confused drivers often change direction suddenly or stop without warning. Confusion is common near freeway or turnpike interchanges and major intersections. Tourists unfamiliar with the area can be very hazardous. Clues to tourists include car-top luggage and out-of-state license plates. Unexpected actions (stopping in the middle of a block, changing lanes for no apparent reason, backup lights suddenly going on) are clues to confusion. Hesitation is another clue, including driving very slowly, using brakes often, or stopping in the middle of an intersection. You may also see drivers who are looking at street signs, maps, and house numbers. These drivers may not be paying attention to you.

Slow Drivers: Motorists who fail to maintain normal speed are hazards. Seeing slow moving vehicles early can prevent a crash. Some vehicles, by their nature, are slow and seeing them is a hazard clue (mopeds, farm machinery, construction machinery, tractors, etc.). Watch for the “slow moving vehicle” warning placard: a red triangle with an orange center.

Drivers Signaling a Turn May Be a Hazard: Drivers signaling a turn may slow more than expected or stop. If they are making a tight turn into an alley or driveway, they may go very slowly. If pedestrians or other vehicles block them, they may have to stop on the roadway. Vehicles turning left may have to stop for oncoming vehicles.

Drivers in a Hurry: Drivers may feel your commercial vehicle is preventing them from getting where they want to go on time. Such drivers may pass you without a safe gap in the oncoming traffic and cutting too close in front of you. Drivers entering the road may pull in front of you in order to avoid being stuck behind you, causing you to brake. Be aware of this and watch for drivers who are in a hurry.

Impaired Drivers: Drivers who are sleepy, have had too much to drink, are on drugs, or who are ill are hazards. Some clues to these drivers are:

- Weaving across the road or drifting from one side to another.
- Leaving the road (dropping right wheels onto the shoulder, or bumping across a curb in a turn).
- Stopping at the wrong time (stopping at a green light, or waiting for too long at a stop).
- Open window in cold weather.
- Speeding up or slowing down suddenly, driving too fast or too slow.

Be alert for drunk drivers and sleepy drivers late at night.

Driver Body Movement as a Clue: Drivers look in the direction they are going to turn. You may sometimes get a clue from a driver's head and body movements that a driver may be going to make a turn, even though the turn signals aren't on. Drivers making over-the-

shoulder checks may be going to change lanes. These clues are most easily seen in motorcyclists and bicyclists. Watch other road users and try to tell whether they might do something hazardous.

Conflicts: You are in conflict when you have to change speed and/or direction to avoid hitting someone. Conflicts occur at intersections where vehicles meet, at merges (such as turnpike on-ramps) and where there are needed lane changes (such as the end of a lane, forcing a move to another lane of traffic). Other situations include slow moving or stalled traffic in a traffic lane and accident scenes. Watch for other drivers who are in conflict, because they are a hazard to you. When they react to this conflict, they may do something that will put them in conflict with you.

2.8.4 Always Have a Plan

You should always be looking for hazards. Continue to learn to see hazards on the road; however, don't forget why you are looking for the hazards - they may turn into emergencies. You look for the hazards in order to have time to plan a way out of any emergency. When you see a hazard, think about the emergencies that could develop and figure out what you would do. Always be prepared to take action based on your plans. In this way, you will be a prepared, defensive driver who will improve your own safety as well as the safety of all road users.

Subsections 2.7 and 2.8

Test Your Knowledge

1. How do you find out how many seconds of following distance space you have?
2. If you are driving a 30-foot vehicle at 55 mph, how many seconds of following distance should you allow?
3. You should decrease your following distance if somebody is following you too closely. True or False?
4. If you swing wide to the left before turning right, another driver may try to pass you on the right. True or False?

5. What is a hazard?
6. Why make emergency plans when you see a hazard?

These questions may be on the test. If you can't answer them all, re-read subsections 2.7 and 2.8.

2.9 DISTRACTED DRIVING

Whenever you are driving a vehicle and your attention is not on the road, you're putting yourself, your passengers, other vehicles, and pedestrians in danger. Distracted driving can result when you perform any activity that may shift your full attention from the driving task. Taking your eyes off the road or hands off the steering wheel presents obvious driving risks. Mental activities that take your mind away from driving are just as dangerous. Your eyes can gaze at objects in the driving scene but fail to see them because your attention is distracted elsewhere.

Activities that can distract your attention include: talking to passengers; adjusting the radio, CD player, or climate controls; eating, drinking, or smoking; reading maps or other literature; picking up something that fell; reading billboards and other road advertisements; watching other people and vehicles including aggressive drivers; talking on a cell phone or CB radio; texting, using devices such as GPS navigation systems, pagers, etc.; daydreaming or being occupied with other mental distractions.

2.9.1 Don't Drive Distracted

If drivers react just one half second slower because of distractions, crashes double. Some tips to follow so you won't become distracted:

- Pre-program radio stations and have your other music or media at hand. Preview and be totally familiar with all of the safety and usage features on any in-vehicle electronics, including your cell phone, before you drive.
- Pre-program cell phones with commonly called numbers (Speed Dial) if you intend to dial any numbers while driving (see 2.9.2).
- Review maps and plan your route before you begin driving. Program your GPS and preview your route to avoid surprises.

- Clear the vehicle of any unnecessary objects. Adjust all mirrors for best all-round visibility before you start your trip.
- Don't attempt to read or write while you drive. Do not attempt to type or read messages on your satellite system or other device while driving.
- Avoid smoking, eating, and drinking while you drive. Don't engage in complex or emotionally intense conversations with other occupants of your vehicle.

2.9.2 In-vehicle Communication Equipment

Mobile Telephones (Cell Phones)

U.S. Department of Transportation (DOT) research indicates that both reaching for and dialing a mobile telephone increase the odds of a CMV driver's involvement in a safety- critical event, such as a crash, near crash, or unintended lane departure. These increases in risk are mostly because the driver's eyes are off the forward roadway.

While no State has completely banned mobile telephone use, some States have very restrictive rules for certain categories of drivers. Many States prohibit the use of all mobile telephones while driving a school bus, transit bus, or motor coach. Other States have traffic laws prohibiting all motor vehicle drivers from using a hand-held mobile telephone while driving.



Driver using hand-held mobile telephone

Because Commercial Motor Vehicle drivers are held to higher standards, FMCSA believes it is in the best interest of public safety to restrict a CMV driver's use of such devices. Therefore, new Federal rules require that only hands-free devices can be used while driving a CMV.



Driver using Wireless headset

This rulemaking restricts a CMV driver from holding a mobile telephone to conduct a voice communication, dialing a mobile telephone by pressing more than a single button, or reaching for a mobile phone in an unacceptable and unsafe manner (e.g. reaching for any mobile telephone on the passenger seat, under the driver's seat, or into the sleeper berth).

Federal Law §392.82 reads in part:

1. No driver shall use a hand-held mobile telephone while driving a CMV.
2. No motor carrier shall allow or require its drivers to use a hand-held mobile telephone while driving a CMV.
3. For the purposes of this section, driving means operating a commercial motor vehicle on a highway, including being temporarily stationary because of traffic, a traffic control device, or other momentary delays.

“Driving” does not include operating a commercial motor vehicle when the driver has moved the vehicle to the side of, or off, a highway and has halted in a location where the vehicle can safely remain stationary. In an emergency, using a hand-held mobile telephone is permissible by drivers of a CMV when necessary to

communicate with law enforcement officials or other emergency services.

A driver of a CMV who desires to use a mobile phone to make and receive calls while driving must ensure that:

- the mobile telephone is located in close proximity to the driver
- The telephone is accessible when the driver is in the normal seated driving position and properly restrained by a seat belt.
- The telephone has a hands-free mobile speaker phone function or is connected to a wired or wireless earphone.
- the driver is able to make, answer, or terminate a call by touching a single button on the phone or on a headset
- use of the phone does not require the driver to take his or her eyes off of the forward roadway for an extended period--comparable to using vehicle controls or instrument panel functions, such as the radio or climate control system.
- Keep conversations short. Never use the cell phone for social visiting while driving.

While a headset or other device helps keep your hands free, you may still become distracted while talking on a mobile phone while driving. If possible, turn the cell phone off until your destination is reached, or let calls go to your voicemail and return them when it is safe to do so.

If you do not have a “compliant” mobile phone (one that has a speaker or other hands free connection) and you must use your cell phone, pull off the road in a safe, legal place when making or receiving a call. Do not place a call while driving.

Hang up in demanding traffic situations. It is not safe to talk on a mobile phone, with or without a hands free device, while driving in heavy traffic, road construction, heavy pedestrian traffic, or severe weather conditions.

PUSH TO TALK MOBILE PHONES: Because the push-to talk features use commercial mobile radio services to transmit and receive voice communications, the device is a mobile telephone; and it also requires the driver or user to hold it. Therefore, its use while driving a CMV is the same as that of a hand-held mobile telephone and is prohibited.

A violation of the hands free cell phone rule is considered to be a serious violation and stiff penalties

can result. Any violation of this restriction may result in a civil penalty imposed on drivers in an amount up to \$2,750. Employers who fail to require their drivers to comply with safety regulations can be fined up to \$11,000. A first offense could result in a civil penalty against the driver. If a driver is convicted of committing a second hand-held mobile telephone use violation within 3 years, he or she would be disqualified for 60 days, in addition to being subject to the applicable civil penalty. For three or more hand-held mobile telephone use convictions for violations committed within 3 years, a driver would be disqualified for 120 days, in addition to being subject to the applicable civil penalty.

NOTE: Nothing in the rule authorizes enforcement officers to require a driver to make a mobile telephone available so that the officer can review call history for purposes of enforcing this rule.

Texting prohibited

FMCSA has several studies showing the dangers of texting. “Total eyes-off-road time when texting while driving is extremely risky” and “research shows that the odds of being involved in a safety-critical event (e.g., crash, near-crash, unintentional lane deviation) is 23.2 times greater when texting while driving.”

The Idaho legislature recently passed a law which prohibits texting while driving in any motor vehicle (Idaho Code 49-1401A). A violation of this law is an infraction.

Federal law §392.80 prohibits a driver from texting while operating a CMV. If you are convicted of texting, you may be disqualified from operating a CMV and your employer cannot allow you to operate the vehicle. Your employer is also prohibited from requiring or allowing their drivers to engage in texting while driving a CMV.

- **Texting while operating a CMV is illegal and is considered a serious offense**
- Texting means manually entering alphanumeric text into, or reading text from, an electronic device
- This action includes, but is not limited to, short message service, emailing, instant messaging, a command or request to access a World Wide Web page, pressing more than a single button to initiate or terminate a voice communication

using a mobile telephone, or engaging in any other form of electronic text retrieval or entry, for present or future communication.

Texting does not include:

- Inputting, selecting, or reading information on a global positioning system or navigation system;
- Pressing a single button to initiate or terminate a voice communication using a mobile telephone
- Using a device capable of performing multiple functions (e.g., fleet management systems, dispatching devices, smart phones, citizens band radios, music players, etc.) for a purpose that is not otherwise prohibited.

2.9.3 Watch Out for Other Distracted Drivers

You need to be able to recognize other drivers who are engaged in any form of driving distraction. Not recognizing other distracted drivers can prevent you from perceiving or reacting correctly in time to prevent a crash. Watch for:

- Vehicles that may drift over the lane divider lines or within their own lane.
- Vehicles traveling at inconsistent speeds.
- Drivers who are preoccupied with maps, food, cigarettes, cell phones, or other objects.
- Drivers who appear to be involved in conversations with their passengers.

Give a distracted driver plenty of room and maintain your safe following distance.

Be very careful when passing a driver who seems to be distracted. The other driver may not be aware of your presence, and they may drift in front of you.

2.10 AGGRESSIVE DRIVERS/ROAD RAGE

2.10.1 What Is It?

Aggressive driving and road rage are not new problems; however, in today's world, where heavy and slow-

moving traffic and tight schedules are the norm, more and more drivers are taking out their anger and frustration in their vehicles.

Crowded roads leave little room for error, leading to suspicion and hostility among drivers and encouraging them to take personally the mistakes of other drivers.

Aggressive driving is the act of operating a motor vehicle in a selfish, bold, or pushy manner, without regard for the rights or safety of others.

Road rage is operating a motor vehicle with the intent of doing harm to others or physically assaulting a driver or their vehicle.

2.10.2 Don't Be an Aggressive Driver

- How you feel before you even start your vehicle has a lot to do with how stress will affect you while driving.
- Reduce your stress before and while you drive. Listen to "easy listening" music.
- Give the drive your full attention. Don't allow yourself to become distracted by talking on your cell phone, eating, etc.
- Be realistic about your travel time. Expect delays because of traffic, construction, or bad weather and make allowances.
- If you're going to be later than you expected – deal with it. Take a deep breath and accept the delay.
- Give other drivers the benefit of the doubt. Try to imagine why he or she is driving that way. Whatever their reason, it has nothing to do with you.
- Slow down and keep your following distance reasonable.
- Don't drive slowly in the left lane of traffic.
- Avoid gestures. Keep your hands on the wheel. Avoid making any gestures that might anger another driver. Even seemingly harmless expressions of irritation like shaking your head can trigger anger in another driver.

- Be a cautious and courteous driver. If another driver seems eager to get in front of you, say, “Be my guest”. This response will soon become a habit, and you won’t be as offended by other drivers’ actions.

2.10.3 What You Should Do When Confronted by an Aggressive Driver

- First and foremost, make every attempt to get out of their way.
- Put your pride in the back seat. Do not challenge them by speeding up or attempting to hold your own in your travel lane.
- Avoid eye contact.
- Ignore gestures and refuse to react to them.
- Report aggressive drivers to the appropriate authorities by providing a vehicle description, license plate number, location, and if possible, direction of travel.
- If you have a cell phone, and can do it safely, call the police.
- If an aggressive driver is involved in a crash farther down the road, stop a safe distance from the crash scene, wait for the police to arrive, and report the driving behavior that you witnessed.

Subsections 2.9 and 2.10

Test Your Knowledge

1. What are some tips to follow so you won’t become a distracted driver?
2. How do you use in-vehicle communications equipment cautiously?
3. How do you recognize a distracted driver?
4. What is the difference between aggressive driving and road rage?
5. What should you do when confronted with an aggressive driver?

6. What are some things you can do to reduce your stress before and while you drive?

These questions may be on the test. If you can’t answer them all, re-read subsections 2.9 and 2.10.

2.11 DRIVING AT NIGHT

2.11.1 More Dangerous

You are at greater risk when you drive at night. Drivers can’t see hazards as quickly as in daylight, so they have less time to respond. Drivers caught by surprise are less able to avoid a crash. The problems of night driving involve the driver, the roadway, and the vehicle.

2.11.2 Driver Factors

Vision: People can’t see as sharply at night or in dim light. Also, their eyes need time to adjust to seeing in dim light. Most people have noticed this when walking into a dark movie theater.

Glare: Drivers can be blinded for a short time by bright light. It takes time to recover from this blindness. Older drivers are especially bothered by glare. Most people have been temporarily blinded by camera flash units or by the high beams of an oncoming vehicle. It can take several seconds to recover from glare. Even two seconds of glare blindness can be dangerous. A vehicle going 55 mph will travel more than 1/2 the distance of a football field during that time. Don’t look directly at bright lights when driving. Look at the right side of the road and watch the sidelines when someone coming toward you has very bright lights on.

Fatigue and Lack of Alertness: Fatigue (being tired) and lack of alertness are bigger problems at night. The body’s need for sleep is beyond a person’s control. Most people are less alert at night, especially after midnight. This is particularly true if you have been driving for a long time. Drivers may not see hazards as soon, or react as quickly, so the chance of a crash is greater. If you are sleepy, the only safe cure is to get off the road and get some sleep. If you don’t, you risk your life and the lives of others.

2.11.3 Roadway Factors

Poor Lighting: In the daytime there is usually enough light to see well. This is not true at night. Some areas

may have bright street lights, but many other areas will have poor lighting. On most roads you will probably have to depend entirely on your headlights.

Less light means you will not be able to see hazards as well as in the daytime. Road users who do not have lights are hard to see. There are many accidents at night involving pedestrians, joggers, bicyclists, and animals.

Even when there are lights, the road scene can be confusing. Traffic signals and other hazards can be hard to see against a background of signs, shop windows, and the glare of other lights.

Drive slower when lighting is poor or confusing. Drive slowly enough to be sure you can stop in the distance you can see ahead.

Drunk Drivers: Drunk drivers and drivers under the influence of drugs are a hazard to themselves and to you. Be especially alert around the closing times for bars and taverns. Watch for drivers who have trouble staying in their lane or maintaining speed, who stop without reason, or show other signs of being under the influence of alcohol or drugs.

2.11.4 Vehicle Factors

Headlights: At night your headlights will usually be the main source of light for you to see by and for others to see you. You can't see nearly as much with your headlights as you see in the daytime. With low beams you can see ahead about 250 feet and with high beams about 350-500 feet. You must adjust your speed to keep your stopping distance within your sight distance. This means going slowly enough to be able to stop within the range of your headlights, otherwise, by the time you see a hazard, you will not have time to stop. Night driving can be more dangerous if you have problems with your headlights. Dirty headlights may give only half the light they should. This cuts down your ability to see, and makes it harder for others to see you. Make sure your lights are clean and working. Headlights can be out of adjustment. If they don't point in the right direction, they won't give you a good view, and they can blind other drivers. Have a qualified person make sure they are adjusted properly.

Other Lights: In order for you to be seen easily, the following must be clean and working properly:

- Reflectors.
- Marker lights.
- Clearance lights.
- Taillights.
- Identification lights.

Turn Signals and Brake Lights: At night your turn signals and brake lights are even more important for telling other drivers your intentions. Make sure you have clean, working turn signals and stop lights.

Windshield and Mirrors: It is more important at night than in the daytime to have a clean windshield and clean mirrors. Bright lights at night can cause dirt on your windshield or mirrors to create a glare of its own and block your view. Most people have experienced driving toward the sun just as it has risen or is about to set and found that they can barely see through a windshield that seemed to look OK in the middle of the day. Clean your windshield on the inside and outside for safe driving at night.

2.11.5 Night Driving Procedures

Pre-trip Procedures: Make sure you are rested and alert. If you are drowsy, sleep before you drive! Even a nap can save your life or the lives of others. If you wear eyeglasses, make sure they are clean and unscratched and don't wear sunglasses at night. Do a complete pre-trip inspection of your vehicle and make sure all lights are operational and light lenses, reflectors and reflector tape are clean. Clean those you can reach.

Avoid Blinding Others: Glare from your headlights can cause problems for drivers coming toward you. They can also bother drivers going in the same direction you are when your lights shine in their rearview mirrors. Dim your lights before they cause glare for other drivers. Dim your lights within 500 feet of an oncoming vehicle and when following another vehicle within 500 feet.

Avoid Glare from Oncoming Vehicles: Do not look directly at lights of oncoming vehicles. Look slightly to the right at a right lane or edge marking, if available. If other drivers don't switch their headlights to low beams, don't try to "get back at them" by switching

your headlights to high beams. This increases glare for oncoming drivers and increases the chance of a crash.

Use High Beams When You Can: Some drivers make the mistake of always using low beams. This seriously cuts down on their ability to see ahead. Use high beams when it is safe and legal to do so. Use them when you are not within 500 feet of an approaching vehicle. Also, don't let the inside of your cab get too bright. This makes it harder to see outside. Keep the interior light off, and adjust your instrument lights as low as you can to still be able to read the gauges.

If You Get Sleepy, Stop Driving at the Nearest Safe Place: People often don't realize how close they are to falling asleep even when their eyelids are falling shut. If you can safely do so, look at yourself in a mirror, if you look sleepy, or you just feel sleepy, stop driving! You are in a very dangerous condition and the only safe cure is to sleep.

2.12 DRIVING IN FOG

Fog can occur at any time. Fog on highways can be extremely dangerous. Fog is often unexpected, and visibility can deteriorate rapidly. You should watch for foggy conditions and be ready to reduce your speed. Do not assume that the fog will thin out after you enter it. The best advice for driving in fog is don't. It is preferable that you pull off the road into a rest area or truck stop until visibility is better. If you must drive, be sure to consider the following:

- Obey all fog-related warning signs.
- Slow down before you enter fog.
- Use low-beam headlights and fog lights for the best visibility even in daytime, and be alert for other drivers who may have forgotten to turn on their lights.
- Turn on your 4-way flashers. This will give vehicles approaching you from behind a quicker opportunity to notice your vehicle.
- Watch for vehicles on the side of the roadway. Seeing taillights or headlights in front of you may not be a true indication of where the road is ahead of you. The vehicle may not be on the road at all.

- Use roadside highway reflectors as guides to determine how the road may curve ahead of you.
- Listen for traffic you cannot see.
- Avoid passing other vehicles.
- Don't stop along the side of the road, unless absolutely necessary.

2.13 DRIVING IN WINTER

2.13.1 Vehicle Checks

Make sure your vehicle is ready before driving in winter weather. You should make a regular pre-trip inspection paying extra attention to the following items:

Coolant Level and Antifreeze Amount: Make sure the cooling system is full and there is enough antifreeze in the system to protect against freezing. This can be checked with a special coolant tester.

Defrosting and Heating Equipment: Make sure the defrosters work. They are needed for safe driving. Make sure the heater is working, and that you know how to operate it. If you use other heaters and expect to need them (i.e., mirror heaters, battery box heaters, cargo heaters and fuel tank heaters), check their operation.

Wipers and Washers: Make sure the windshield wiper blades are in good condition. Make sure the wiper blades press against the window hard enough to wipe the windshield clean, otherwise they may not sweep off snow or water properly. Make sure the windshield washer works and there is washing fluid in the washer reservoir. Use windshield washer antifreeze to prevent freezing of the washer liquid. If you can't see well enough while driving (for example, if your wipers fail), stop safely and fix the problem.

Tires: Make sure you have enough tread on your tires. The drive tires must provide traction to push the vehicle over wet pavement and through snow. The steering tires must have traction to steer the vehicle. Having enough tread is especially important in winter conditions. **You must have at least 4/32 inch tread depth in every major groove on front tires and at least 2/32 inch on other tires** (more tread would be even

better). Use a gauge to determine if you have enough tread for safe driving.

Tire Chains: You may find yourself in conditions where you can't drive without chains. This may be true even to get to a place of safety. Carry the right number of chains and extra cross-links. Make sure they will fit your drive and trailer tires. Check the chains for broken hooks, worn or broken cross-links, and bent or broken side chains. Learn how to put the chains on before you need to do it in snow and ice. Check the chain laws of each state you will drive through in order to determine their chain requirements on different vehicle configurations.

Lights and Reflectors: Make sure the lights and reflectors are clean. Lights and reflectors are especially important during bad weather. Check from time to time during bad weather to make sure they are clean and working properly.

Windows and Mirrors: Remove any ice, snow, etc., from the windshield, windows, and mirrors before starting on your trip. Use a windshield scraper, snow brush, and windshield defroster as necessary.

Hand Holds, Steps, and Deck Plates: Remove all ice and snow from hand holds, steps, and deck plates. This will reduce the danger of slipping.

Radiator Shutters and Winter-front: Remove ice from the radiator shutters. Make sure the winter-front is not closed too tightly. If the shutters freeze shut or the winter-front is closed too much, the engine may overheat and stop. Watch the engine temperature gauge for signs that the engine is over-heating.

Exhaust System: Exhaust system leaks are especially dangerous when cab ventilation may be poor (windows rolled up, etc.). Loose connections could permit poisonous carbon monoxide to leak into your vehicle. Carbon monoxide gas will cause you to be sleepy and in large enough amounts can kill you and/or your passengers. Check the exhaust system for holes, loose parts and for sounds and signs of leaks.

2.13.2 Driving

Slippery Surfaces: Do not use your cruise control or engine retarder (Jake Brake) while traveling on slippery surfaces. Drive slowly and smoothly on slippery roads.

Start Gently and Slowly: When first starting, get the feel of the road. Don't hurry.

Check for Ice: Check for ice on the road, especially bridges and overpasses. A lack of spray from other vehicles indicates ice has formed on the road. Also, check your mirrors and wiper blades for ice. If they have ice, the road most likely will be icy as well.

Adjust Turning and Braking to Conditions: Make turns as gently as possible. Don't brake any harder than necessary, and don't use the engine brake or speed retarder. (They can cause the driving wheels to skid on slippery surfaces).

Adjust Speed to Conditions: Do not use your cruise control while traveling on slippery surfaces. Don't pass slower vehicles unless necessary. Go slowly and watch far enough ahead to keep a steady speed. Avoid having to slow down and speed up. Take curves at slower speeds and don't brake while in the curves. Be aware that as the temperature rises to the point where ice begins to melt, the road becomes even more slippery. Slow down more.

Adjust Space to Conditions: Don't drive alongside other vehicles and keep a longer following distance. When you see a traffic jam ahead, slow down or stop to wait for it to clear. Try hard to anticipate stops early and slow down gradually. Watch for snowplows, as well as salt and sand trucks and give them plenty of room.

Wet Brakes: When driving in heavy rain or deep standing water, your brakes will get wet. Water in the brakes can cause the brakes to be weak, apply unevenly, or grab. This can cause lack of braking power, wheel lockups, pulling to one side or the other, and a jackknife if you pull a trailer. Avoid driving through deep puddles or flowing water if possible. If not, you should:

- Slow down and place transmission in a low gear.
- Gently put on the brakes. This presses linings against brake drums or discs and keeps mud, silt, sand, and water from getting in.
- Increase engine rpm and cross the water while keeping light pressure on the brakes.
- When out of the water, maintain light pressure on the brakes for a short distance to heat them up and dry them out.

- Make a test stop when safe to do so. Check behind you to make sure no one is following, then apply the brakes to be sure they work well. If not, dry them out further as described above. (CAUTION: Do not apply too much brake pressure and accelerator at the same time, or you can overheat the brake drums/rotors and linings/pads.)

2.14 DRIVING IN VERY HOT WEATHER

2.14.1 Vehicle Checks

Do a normal pre-trip inspection, but pay special attention to the following items:

Tires: Check the tire mounting and air pressure. Inspect the tires every two hours or every 100 miles when driving in very hot weather. Air pressure increases with temperature. Do not let air out or the pressure will be too low when the tires cool off. If a tire is too hot to touch, remain stopped until the tire cools off, otherwise the tire may blow out or catch fire.

Engine Oil: The engine oil helps keep the engine cool, as well as lubricating it. Make sure there is enough engine oil. If you have an oil temperature gauge, make sure the temperature is within the proper range while you are driving.

Engine Coolant: Before starting out, make sure the engine cooling system has enough water and antifreeze according to the engine manufacturer's directions (Antifreeze helps the engine under hot conditions as well as cold conditions). When driving, check the water or coolant temperature gauge occasionally to make sure the vehicle is operating in the normal range. If the gauge goes above the highest safe temperature, there may be something wrong that could lead to engine failure and possibly fire. Stop driving as soon as safely possible and try to find out what is wrong.

Some vehicles have sight glasses, see-through coolant over-flow containers, or coolant recovery containers. These permit you to check the coolant level while the engine is hot. If the container is not part of the pressurized system, the cap can be safely removed and coolant added even when the engine is at operating temperature.

Never remove the radiator cap or any part of the pressurized system until the system has cooled: Steam and boiling water can spray under pressure and cause severe burns. If you can touch the radiator cap with your bare hand, it is probably cool enough to open.

If coolant has to be added to a system without a recovery tank or overflow tank, follow these steps:

1. Shut engine off.
2. Wait until engine has cooled.
3. Protect hands (use gloves or a thick cloth).
4. Turn radiator cap slowly to the first stop, which releases the pressure seal.
5. Step back while pressure is released from cooling system.
6. When all pressure has been released, press down on the cap and turn it further to remove it.
7. Visually check level of coolant and add more coolant if necessary.
8. Replace cap and turn all the way to the closed position.

Engine Belts: Learn how to check V-belt tightness on your vehicle by pressing on the belts. Loose belts will not turn the water pump and/or fan properly. This will result in over-heating. Also, check belts for cracking or other signs of wear.

Hoses: Make sure coolant hoses are in good condition. A broken hose while driving can lead to engine failure and even fire.

2.14.2 Driving

Watch for Bleeding Tar: Tar in the road pavement frequently rises to the surface in very hot weather. Spots where tar "bleeds" to the surface are very slippery.

Go Slowly Enough to Prevent Overheating: High speeds create more heat for tires and the engine. In desert conditions the heat may build up to the point

where it is dangerous. The heat will increase chances of tire failure, fire, and engine failure.

Subsections 2.11, 2.12, 2.13, and 2.14

Test Your Knowledge

1. You should use low beams whenever you can. True or False?
2. What should you do before you drive if you are drowsy?
3. What effects can wet brakes cause? How can you avoid these problems?
4. You should let air out of hot tires so the pressure goes back to normal. True or False?
5. You can safely remove the radiator cap as long as the engine isn't overheated. True or False?

These questions may be on the test. If you can't answer all of them, re-read subsections 2.11, 2.12, 2.13, and 2.14.

2.15 RAILROAD-HIGHWAY CROSSINGS

Railroad-highway grade crossings are a special kind of intersection where the roadway crosses train tracks. These crossings are always dangerous. Every such crossing must be approached with the expectation that a train is coming.

2.15.1 Types of Crossings

Passive Crossings: This type of crossing does not have any type of traffic control device. The decision to stop or proceed rests entirely in your hands. Passive crossings require you to recognize the crossing, search for any train using the tracks and decide if there is sufficient clear space to cross safely. Passive crossings have yellow circular advance warning signs, pavement markings and crossbucks to assist you in recognizing a crossing. (See Figure 2.14)

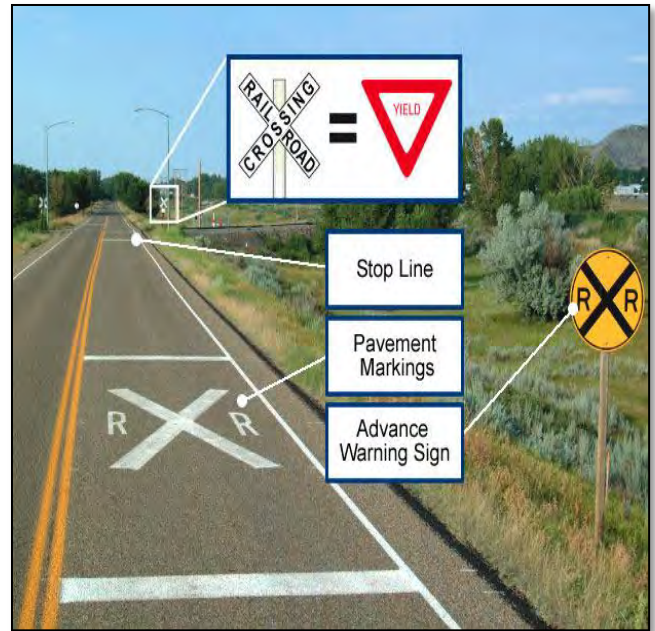

Figure 2.14 Railroad Crossing Signs

Active Crossings: This type of crossing has a traffic control device installed at the crossing to regulate traffic at the crossing. These active devices include flashing red lights, with or without bells and flashing red lights with bells and gates.



2.15.2 Warning Signs and Devices

Advance Warning Signs: The round, black-on-yellow warning sign is placed ahead of a public railroad-highway crossing. The advance warning sign tells you to slow down, look and listen for the train, and be prepared to stop at the tracks if a train is coming (See Figure 2.15)

Figure 2.15 Railroad Crossing Warning Sign

Pavement Markings: Pavement markings mean the same as the advance warning sign. They consist of an "X" with the letters "RR" and a no-passing marking on two-lane roads (See Figure 2.14).

There is also a no passing zone sign on two-lane roads. There may be a white stop line painted on the pavement before the railroad tracks. The front of the school bus must remain behind this line while stopped at the crossing.

Crossbuck Signs: This sign marks the grade crossing. It requires you to yield the right-of-way to the train. If there is no white line painted on the pavement, you must stop the bus before the crossbuck sign. When the road crosses

over more than one set of tracks, a sign below the crossbuck indicates the number of tracks (See Figure 2.16).



Figure 2.16 Crossbuck Sign

Flashing Red Light Signal: At many highway-rail grade crossings, the crossbuck sign has flashing red lights and bells. When the lights begin to flash, **Stop!** A train is approaching. You are required to yield the right-of-way to the train. If there is more than one track, make sure all tracks are clear before crossing. Many railroad-highway crossings have gates with flashing red lights and bells. Stop when the lights begin to flash and before the gate lowers across the road lane. Remain stopped until the gates go up, and the lights have stopped flashing. Proceed when it is safe (See Figure 2.17).



Figure 2.17 Railroad Crossing Gate & Light with Multiple Track Warning Sign

2.15.3 Driving Procedures

Never Race a Train to a Crossing: Never attempt to race a train to a crossing. It is extremely difficult to judge the speed of an approaching train.

Reduce Speed: Speed must be reduced in accordance with your ability to see approaching trains in any direction, and the speed must be held to a point which will permit you to stop short of the tracks in case a stop is necessary.

Don't Expect to Hear a Train: Because of noise inside your vehicle, you cannot expect to hear the train horn until the train is dangerously close to the crossing.

Don't Rely on Signals: You should not rely solely upon the presence of warning signals, gates, or flagmen to warn of the approach of trains. Be especially alert at crossings that do not have gates or flashing red light signals.

Double Tracks Require a Double Check: Remember that a train on one track may hide a train on the other track. Look both ways before crossing. After one train has cleared a crossing, be sure no other trains are near before starting across the tracks.

Yard areas and grade crossings in cities and towns are just as dangerous as rural grade crossings. Approach them with as much caution.

2.15.4 Stopping Safely at Railroad-Highway Crossings

A full stop is required at grade crossings whenever:

- The nature of the cargo makes a stop mandatory under state or federal regulations.
- A stop is otherwise required by law.

When stopping be sure to:

- Check for traffic behind you while stopping gradually. Use a pullout lane, if available
- Turn on your four-way emergency flashers.

2.15.5 Crossing the Tracks

Railroad crossings with steep approaches can cause your unit to hang up on the tracks.

Never permit traffic conditions to trap you in a position where you have to stop on the tracks. Be sure you can get all the way across the tracks before you start across. It takes a typical tractor-trailer unit at least 14 seconds to clear a single track and more than 15 seconds to clear a double track.

Do not shift gears while crossing railroad tracks. It is against the Federal Motor Carrier Safety Regulations and Idaho Code to shift gears while crossing railroad tracks.

2.15.6 Special Situations

Be Aware! The following trailers can get stuck on raised crossings:

- Low slung units (lowboy, car carrier, moving van, possum-belly livestock trailer).
- Single-axle tractor pulling a long trailer with its landing gear set to accommodate a tandem-axle tractor.

If for any reason you get stuck on the tracks, get out of the vehicle and away from the tracks. Check signposts or signal housing at the crossing for emergency notification information. Call 911 or other emergency number and give the location of the crossing using all identifiable landmarks, especially the DOT number, if posted.

2.16 MOUNTAIN DRIVING

In mountain driving, gravity plays a major role. On any upgrade, gravity slows you down. The steeper the grade, the longer the grade, and/or the heavier the load, the more you will have to use lower gears to climb hills or mountains. In coming down long, steep downgrades, gravity causes the speed of your vehicle to increase. You must select an appropriate safe speed, use a low gear, and proper braking techniques. You should plan ahead and obtain information about any long steep grades along our planned route of travel. If possible, talk to other drivers who are familiar with the grades to find out what speeds are safe.

You must go slowly enough so your brakes can hold you back without getting too hot. If the brakes become too hot, they may start to “fade.” This means you have to apply them harder and harder to get the same stopping power. If you continue to use the brakes hard, they can keep fading until you cannot slow down or stop at all. Also, over-heated brakes can catch fire. Before starting down a hill, check your brakes by gently applying the foot brake to ensure that they are functioning properly.

2.16.1 Select a “Safe” Speed

Your most important consideration when faced with a steep downgrade is to select a safe speed that is not too fast for the following circumstances:

- Total weight of the vehicle and cargo.
- Length of the grade.
- Steepness of the grade.
- Road conditions.
- Weather.

If a speed limit is posted, or there is a sign indicating “Maximum Safe Speed,” never exceed the speed shown. Also, look for and heed warning signs indicating the length and steepness of the grade.

You must use the braking effect of the engine as the principal way of controlling your speed. The braking effect of the engine is greatest when it is near the governed rpm setting, and the transmission is in the lower gears. Save your brakes so you will be able to slow or stop as required by road and traffic conditions.

2.16.2 Select the Right Gear before Starting Down the Grade

Shift the transmission to a low gear before starting down the grade. Do not try to downshift after your speed has already built up. You will not be able to shift into a lower gear. You may not even be able to get back into any gear and all engine braking effect will be lost. Forcing an automatic transmission into a lower gear at high speed could damage the transmission and also lead to loss of all engine braking effect.

With older trucks, a rule for choosing gears is to use the same gear going down a hill that you would need to

climb the hill. However, new trucks have low friction parts and streamlined shapes for fuel economy and they may also have more powerful engines. This means they can go up hills in higher gears and have less friction and air drag to hold them back going down hills. For that reason, drivers of modern trucks may have to use lower gears going down a hill than would be required to go up the hill. You should know what is right for your vehicle.

2.16.3 Brake Fading or Failure

Brakes are designed so brake shoes or pads rub against the brake drum or rotors to slow the vehicle. Braking creates heat, but brakes are designed to take a lot of heat. However, brakes can fade or fail from excessive heat caused by using them too much and not relying on the engine braking effect.

Brake fade is also affected by adjustment. To safely control a vehicle, every brake must do its share of the work. Brakes out of adjustment will stop doing their share before those that are in adjustment. The other brakes can then overheat and fade, and there will not be enough braking available to control the vehicle. Brakes can get out of adjustment quickly, especially when they are used a lot; also, brake linings wear faster when they are hot. Therefore, brake adjustment must be checked frequently.

2.16.4 Proper Braking Technique

Remember, the use of brakes on a long and/or steep downgrade is only a supplement to the braking effect of the engine. Once the vehicle is in the proper low gear, the following is the proper braking technique:

1. Apply the brakes just hard enough to feel a definite slowdown.
2. When your speed has been reduced to approximately five mph below your "safe" speed, release the brakes (This brake application should last for about three seconds).
3. When your speed has increased to your "safe" speed, repeat steps 1 and 2.

For example, if your "safe" speed is 40 mph, you would not apply the brakes until your speed reaches 40 mph. You now apply the brakes hard enough to gradually

reduce your speed to 35 mph and then release the brakes. Repeat this as often as necessary until you have reached the end of the downgrade.

Braking Technique Review

1. Use the braking effect of your engine as the principal way to control your speed.
2. To supplement the braking effect of your engine when going downhill:
 - a. Apply the brakes hard enough to feel a definite slowdown.
 - b. When your speed has been reduced to 5 m.p.h. below your "safe" speed, release the brakes.
 - c. When your speed has increased to your "safe" speed, repeat steps "a" and "b."

Truck Escape Ramps: Escape ramps have been built on many steep mountain downgrades. These ramps are made to stop runaway vehicles safely without injuring drivers and passengers. Escape ramps use a long bed of loose soft material to slow a runaway vehicle, sometimes in combination with an up-grade. All ramps are clearly signed with easily accessible entrances.

The major problems you may encounter on Idaho's mountain highways are:

- Failing to shift into a lower gear at the top of the hill.
- Driving too fast.
- Using brakes too much.
- Falling rocks.
- Large animals on the road (livestock, deer and elk).
- Aggressive, impatient drivers.
- Narrow, winding roads.

The danger signs to watch for when driving down mountain highways are:

- Any air application over 10 p.s.i. to the brakes.
- Smoking brakes.
- Fading brakes or diminished stopping power.
- The engine rpm starts to exceed normal cruise rpm.

If you use an escape ramp, make sure to lock your brakes after stopping. Use your cell phone or flag a motorist down who can contact a towing service, or use your CB radio tuned to channel nine to call for help.



Know the escape ramp locations on your route. Signs show drivers where ramps are located. Escape ramps save lives, equipment, and cargo. Use them if you lose your brakes.

Note: *The only charge for using an escape ramp in Idaho is the tow charge to back your vehicle out.*

Subsections 2.15 and 2.16

Test Your Knowledge

1. What factors determine your selection of a “safe” speed when going down a long, steep downgrade?
2. Why should you be in the proper gear before starting down a hill?
3. Describe the proper braking technique when going down a long, steep downgrade.
4. What type of vehicles can get stuck on a railroad-highway crossing?
5. How long does it take for a typical tractor-trailer unit to clear a double track?

These questions may be on the test. If you can’t answer them all, re-read subsections 2.15 and 2.16.

2.17 DRIVING EMERGENCIES

Traffic emergencies occur when two vehicles are about to collide. Vehicle emergencies occur when tires, brakes, or other critical parts fail. Following the safety practices in this manual can help prevent emergencies. But if an emergency does happen, your chances of avoiding a crash depend upon how well you take action. Actions you can take are discussed below.

2.17.1 Steering to Avoid a Crash

Stopping is not always the safest thing to do in an emergency. When you don’t have enough room to stop, you may have to steer away from what’s ahead. Remember, you can almost always turn to miss an obstacle more quickly than you can stop; however, top-heavy vehicles and tractors with multiple trailers may flip over.

Keep Both Hands on the Steering Wheel: In order to turn quickly, you must have a firm grip on the steering wheel with both hands. The best way to have both hands on the wheel, if there is an emergency, is to keep them there all the time.

How to Turn Quickly and Safely: A quick turn can be made safely, if it’s done the right way. Here are some points that safe drivers use:

- Do not apply the brake while you are turning. It's very easy to lock your wheels while turning, and if that happens, you may skid out of control and/or cause your vehicle to rollover.
- Do not turn any more than needed to clear whatever is in your way. The more sharply you turn, the greater the chances of a skid or rollover.
- Be prepared to "counter-steer," that is, to turn the wheel back in the other direction, once you've passed whatever was in your path. Unless you are prepared to counter-steer, you won't be able to do it quickly enough. You should think of emergency steering and counter-steering as two parts of one driving action.

Where to Steer: If an oncoming driver has drifted into your lane, a move to your right is best. If that driver realizes what has happened, the natural response will be to return to his or her own lane.

If something is blocking your path, the best direction to steer will depend on the situation.

- If you have been using your mirrors, you'll know which lane is empty and can be safely used.
- If the shoulder is clear, going right may be best. No one is likely to be driving on the shoulder but someone may be passing you on the left. You will know if you have been using your mirrors.
- If you are blocked on both sides, a move to the right may be best. At least you won't force anyone into an opposing traffic lane and into a possible head-on collision.

Leaving the Road: In some emergencies, you may have to drive off the road. It may be less risky than facing a collision with another vehicle.

Most shoulders are strong enough to support the weight of a large vehicle and, therefore, offer an available escape route. Here are some guidelines, if you do leave the road.

Avoid Braking: If possible, avoid using the brakes until your speed has dropped to about 20 mph and then brake very gently to avoid skidding on a loose surface.

Keep One Set of Wheels on the Pavement, if Possible: This helps to maintain control.

Stay on the Shoulder: If the shoulder is clear, stay on it until your vehicle has come to a stop. Signal and check your mirrors before pulling back onto the road.

Returning to the Road: If you are forced to return to the road before you can stop, use the following procedure:

- Hold the wheel tightly and turn sharply enough to get right back on the road safely. Don't try to edge gradually back on the road. If you do, your tires might grab unexpectedly and you could lose control.
- When both front tires are on the paved surface, counter-steer immediately. The two turns should be made as a single "steer, counter-steer" move.

2.17.2 How to Stop Quickly and Safely

If somebody suddenly pulls out in front of you, your natural response is to hit the brakes. This is a good response if there's enough distance to stop, and you use the brakes correctly.

You should brake in a way that will keep your vehicle in a straight line and allow you to turn if it becomes necessary. Unless you have ABS on your vehicle, you can use the "controlled braking" method or the "stab braking" method.

Controlled Braking: With this method, you apply the brakes as hard as you can without locking the wheels. Keep steering wheel movements very small while doing this. If you need to make a larger steering adjustment or if the wheels lock, release the brakes. Re-apply the brakes as soon as you can.

Stab Braking:

- Apply your brakes all the way.
- Release brakes when wheels lock up.

- As soon as the wheels start rolling, apply the brakes fully again (It can take up to one second for the wheels to start rolling after you release the brakes. If you re-apply the brakes before the wheels start rolling, the vehicle won't straighten out).

Don't Jam on the Brakes: Unless you have ABS on your vehicle, emergency braking does not mean pushing down on the brake pedal as hard as you can. That will only keep the wheels locked up and cause a skid. If the wheels are skidding, you cannot control the vehicle.

2.17.3 Brake Failure

Brakes kept in good condition rarely fail. Most hydraulic brake failures occur for one of two reasons (Air brakes are discussed in Chapter 5):

1. Loss of hydraulic pressure.
2. Brake fade on long hills.

Loss of Hydraulic Pressure: When the system won't build up pressure, the brake pedal will feel spongy or go to the floor. Following are some things you can do.



Downshift: Putting the vehicle into a lower gear will help to slow the vehicle.

Pump the Brakes: Sometimes pumping the brake pedal will generate enough hydraulic pressure to stop the vehicle.

Use the Parking Brake: The parking or emergency brake is separate from the hydraulic brake system. Therefore, it can be used to slow the vehicle; however, be sure to press the release button or pull the release lever at the same time you use the emergency brake so you can adjust the brake pressure and keep the wheels from locking up.

Find an Escape Route: While slowing the vehicle, look for an escape route - an open field, side-street, or escape ramp. Turning uphill is a good way to slow and stop the vehicle. Make sure the vehicle does not start rolling backward after you stop. Put it in low gear, apply the parking brake, and, if necessary, roll back into some obstacle that will stop the vehicle.

Brake Failure on Downgrades:

Going slow enough and braking properly will almost always prevent brake failure on long downgrades. Once the brakes have failed, however, you are going to have to look outside your vehicle for something to stop it.

Your best hope is to use an escape ramp. If there is one, there'll be signs telling you about it. Ramps are usually located a few miles from the top of the downgrade. Every year, hundreds of drivers avoid injury to themselves or damage to their vehicles by using escape ramps.



Some escape ramps use soft gravel that resists the motion of the vehicle and brings it to a stop. Others turn uphill, using the hill to stop the vehicle and soft gravel to hold it in place.

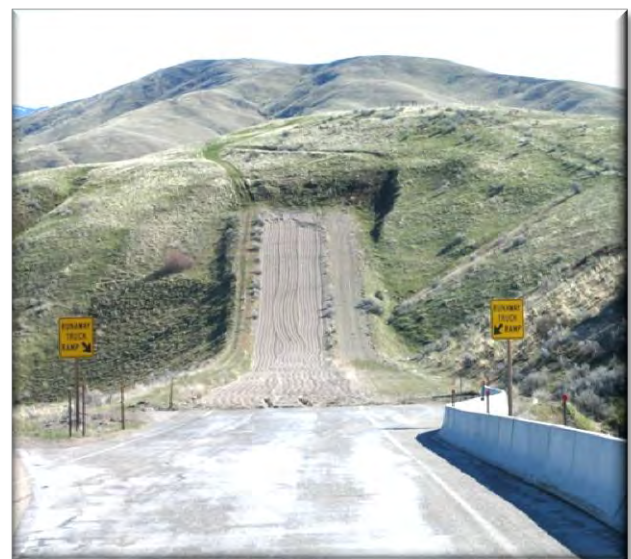

Special Note: Any driver who loses brakes going downhill should use an escape ramp if it's available. There is no fine or penalty for using an escape ramp! If you don't use it, your chances of having a serious crash may be much greater.

If no escape ramp is available, take the least hazardous escape route you can - such as an open field or a side road that flattens out or turns uphill. Make the move as soon as you know your brakes don't work. The longer you wait, the faster the vehicle will go, and the harder it will be to stop or avoid a serious accident.

2.17.4 Tire Failure

Recognize Tire Failure: Quickly knowing you have a tire failure will let you have more time to react. Having just a few extra seconds to remember what it is you're supposed to do can help you. The major signs of tire failure include the following:

- **Sound:** The loud "bang" of a blowout is an easily recognized sign, because it can take a few seconds for your vehicle to react. You might think it was some other vehicle, but any time you hear a tire blow, you'd be safest to assume it is yours.
- **Vibration:** If the vehicle thumps or vibrates heavily, it may be a sign that one of the tires has gone flat. With a rear tire, that may be the only sign you get.
- **Feel:** If the steering feels "heavy," it is probably a sign that one of the front tires has failed. Sometimes, failure of a rear tire will cause the vehicle to slide back and forth or "fishtail." However, dual rear tires usually prevent this.

Respond to Tire Failure: When a tire fails, your vehicle is in danger. You must immediately-

- **Hold the Steering Wheel Firmly:** If a front tire fails, it can twist the steering wheel out of your hand. The only way to prevent this is to keep a firm grip on the steering wheel with both hands at all times.
- **Stay Off the Brake:** It's natural to want to brake in an emergency. However, braking when a tire has failed could cause loss of control.

Unless you're about to run into something, stay off the brake until the vehicle has slowed down, and then brake very gently, pull off the road, and stop.

- **Check the Tires:** After you've come to a stop, get out and check all the tires. Do this even if the vehicle seems to be handling all right. Check the inflation and condition of each of your dual tires and look for other damage a blowout may have caused.

2.18 ANTILOCK BRAKING SYSTEMS (ABS)

ABS is a computerized system that keeps your wheels from locking up during hard brake applications.

ABS is an addition to your normal brakes. It does not decrease or increase your normal braking capability. ABS only activates when wheels are about to lock up.

ABS does not necessarily shorten your stopping distance, but it does help you keep the vehicle under control during hard braking.

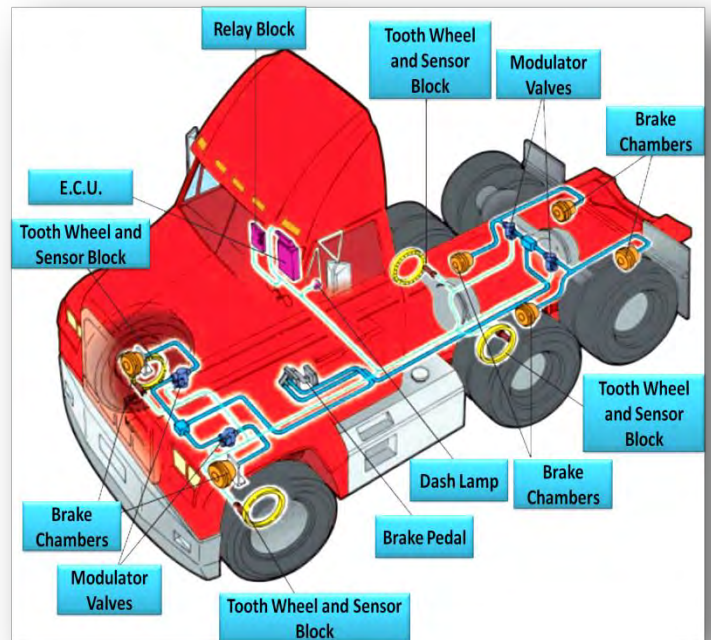

2.18.1 How Antilock Braking Systems Work

Sensors detect potential wheel lock up. An electronic control unit (ECU) will then decrease brake pressure to avoid wheel lockup.

Brake pressure is adjusted to provide the maximum braking without danger of lockup.

ABS works far faster than the driver can respond to potential wheel lockup. At all other times the brake system will operate normally.

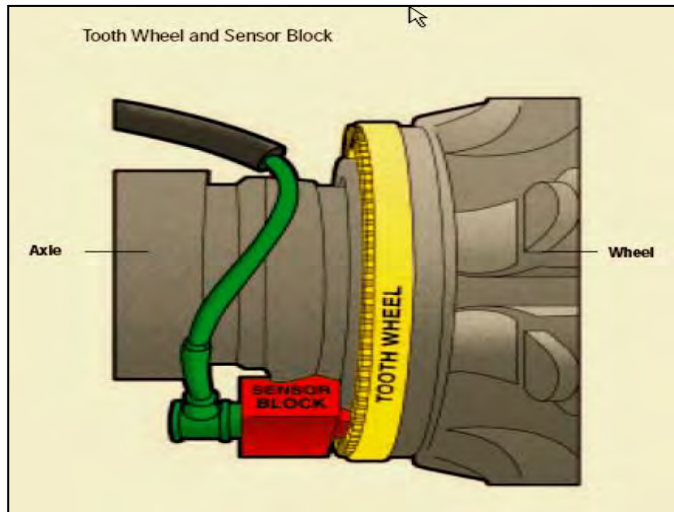

2.18.2 Antilock Braking Systems Required on Newer Vehicles



The Federal Motor Carrier Safety Regulations requires ABS be on:

- Truck tractors with air brakes built on or after March 1, 1997.
- Other air brake vehicles, (trucks, buses, trailers, and converter dollies) built on or after March 1, 1998.

- Hydraulically braked trucks and buses with a gross vehicle weight rating of 10,000 lbs or more built on or after March 1, 1999.

Many commercial vehicles built before these dates have been voluntarily equipped with ABS.

2.18.3 How to Know If Your Vehicle Is Equipped with ABS

Tractors, trucks, and buses will have yellow ABS malfunction lamps on the instrument panel.

Trailers will have yellow ABS malfunction lamps on the left side, either on the front or rear corner.



Dollies manufactured on or after March 1, 1998, are required to have a lamp on the left side.

As a system check on newer vehicles, the malfunction lamp comes on at start-up for a bulb check, and then goes out quickly. On older systems, the lamp could stay on until you are driving over five mph.

If the lamp stays on after the bulb check, or goes on once you are under way, you may have lost ABS control.

In the case of towed units manufactured before it was required by the Department of Transportation, it may be difficult to tell if the unit is equipped with ABS. Look under the vehicle for the ECU and wheel speed sensor wires coming from the back of the brakes.

2.18.4 How ABS Helps You

When you brake hard on slippery surfaces in a vehicle without ABS, your wheels may lock up. When your steering wheels lock up, you lose steering control.

When your other wheels lock up, you may skid, jackknife, or even spin the vehicle.

ABS helps you avoid wheel lock up and maintain control. You may or may not be able to stop faster with ABS, but you should be able to steer around an obstacle while braking, and avoid skids caused by over braking.

2.18.5 ABS on the Tractor Only or Only on the Trailer

Having ABS on only the tractor, only the trailer, or even on only one axle, still gives you more control over the vehicle during braking. Brake normally.

When only the tractor has ABS, you should be able to maintain steering control, and there is less chance of jackknifing, but keep your eye on the trailer and let up on the brakes (if you can safely do so) if it begins to swing out.

When only the trailer has ABS, the trailer is less likely to swing out, but if you lose steering control or start a tractor jackknife, let up on the brakes (if you can safely do so) until you regain control.

If all vehicles in a combination are equipped with working ABS, during an emergency stop when hard braking is required, apply continuous pressure on the brake pedal. Brake fully, but **Do Not Pump the Brake Pedal** as this will defeat the system's design and reduce the effectiveness of the ABS and cause the vehicle to increase its stopping distance. The ABS will activate immediately, allowing you to retain full steering control during hard braking and on slippery surfaces; however, ABS does not decrease stopping distances.

During hard braking with ABS, the system actually pumps the brakes for you at a higher rate than you could do yourself. This pumping action causes a noise from the ABS pump motor, and you may feel a noticeable pulse through the brake pedal. Do not be concerned by the noise and pulsation, because this is normal and there is no reason for concern. Knowing you will hear the pump motor and feel the pulse will help you resist the natural instinct to remove your foot from the brake pedal.

2.18.6 Braking with ABS

When you drive a vehicle with ABS, you should brake as you always have. In other words:

- Use only the braking force necessary to stop safely and stay in control.
- Brake the same way, regardless of whether you have ABS on the bus, tractor, the trailer, or both.
- As you slow down, monitor your tractor and trailer and back off the brakes (if it is safe to do so) to stay in control.
- If all vehicles in a combination are equipped with working ABS, during an emergency stop when hard braking is required, apply continuous pressure on the brake pedal and **Do Not Pump The Brakes.**

2.18.7 Braking If ABS Is Not Working

Without ABS you still have normal brake functions. Drive and brake as you always have. Vehicles with ABS have yellow malfunction lamps to tell you if something isn't working.

As a system check on newer vehicles, the malfunction lamp comes on at start-up for a bulb check and then goes out quickly. On older systems, the lamp could stay on until you are driving over five mph. If the lamp stays on after the bulb check, or goes on once you are under way, you may have lost ABS control on one or more wheels or the ABS sensors could merely be covered in mud or dirt. Remember, if your ABS malfunctions, you still have regular brakes. Drive normally, but get the system serviced soon.

2.18.8 Safety Reminders

- ABS won't allow you to drive faster, follow more closely, or drive less carefully.
- ABS won't prevent power or turning skids. ABS should prevent brake-induced skids or jackknifes, but not those caused by spinning the drive wheels or going too fast in a turn.
- ABS won't necessarily shorten stopping distance. ABS will help maintain vehicle control, but not always shorten stopping distance.

- ABS won't increase or decrease ultimate stopping power. ABS is an "add-on" to your normal brakes, not a replacement for them.
- ABS won't change the way you normally brake. Under normal braking conditions, your vehicle will stop as it always stopped. ABS only comes into play when a wheel would normally have locked up because of over braking.
- ABS won't compensate for bad brakes or poor brake maintenance.
- Remember, the best vehicle safety feature is still a safe driver.
- Remember: drive so you never need to use your ABS.
- Remember: if you need it, ABS could help to prevent a serious crash.
- Remember: don't pump the brakes during an emergency stop if the ABS is working on all vehicles in the combination.

2.19 SKID CONTROL AND RECOVERY

A skid happens whenever the tires lose their grip on the road. This is caused in one of four ways:

Over-braking: Braking too hard and locking up the wheels. Skids also can occur when using the cruise control and speed retarder when the road is slippery.

Over-steering: Turning the wheels more sharply than the vehicle can turn.

Over-acceleration: Supplying too much power to the drive wheels, causing them to spin.

Driving Too Fast: Most serious skids result from driving too fast for road conditions. Drivers who adjust their driving to conditions don't over-accelerate and don't have to over-brake or over-steer from too much speed.

2.19.1 Drive-wheel Skids

By far the most common skid is one in which the rear wheels lose traction through excessive braking or acceleration. Skids caused by acceleration usually happen on ice or snow. Taking your foot off the

accelerator can easily stop them (If it is very slippery, push the clutch in. Otherwise, the engine can keep the wheels from rolling freely and regaining traction).

Rear wheel braking skids occur when the rear drive wheels lock. Because locked wheels have less traction than rolling wheels, the rear wheels usually slide sideways in an attempt to "catch up" with the front wheels. In a bus or straight truck, the vehicle will slide sideways in a "spin out." With vehicles towing trailers, a drive-wheel skid can let the trailer push the towing vehicle sideways, causing a sudden jackknife (See Figure 2.18).

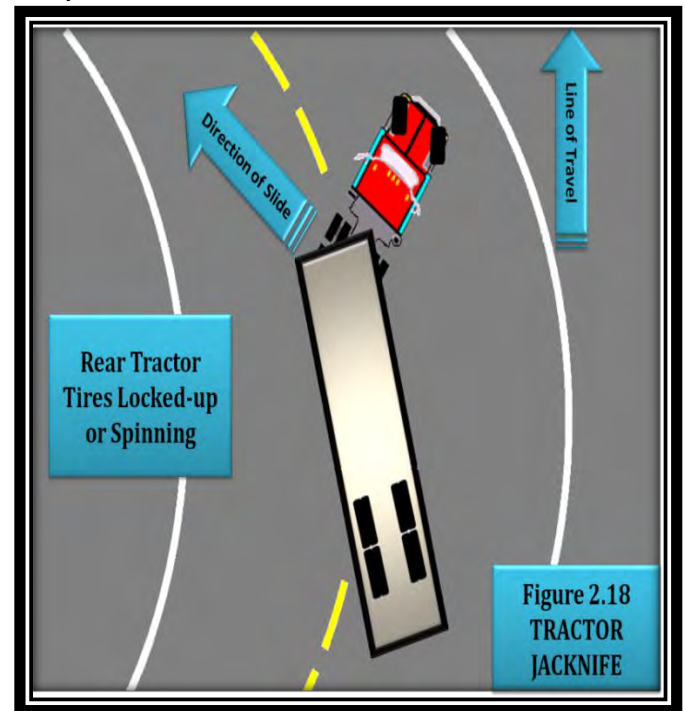

2.19.2 Correcting a Drive-wheel Braking Skid

Do the following to correct a drive-wheel braking skid:

Stop Braking: This will let the rear wheels roll again, and keep the rear wheels from sliding any.

Counter-steer: As a vehicle turns back on course, it has a tendency to keep on turning. Unless you turn the steering wheel quickly the other way, you may find yourself skidding in the opposite direction.

Learning to stay off the brake, turn the steering wheel quickly, push in the clutch, and counter-steer in a skid takes a lot of practice. The best place to get this practice is on a large driving range or "skid pad."

2.19.3 Front-wheel Skids

Driving too fast for conditions causes most front-wheel skids. Other causes include lack of tread on the front tires and cargo loaded so not enough weight is on the front axle. In a front-wheel skid, the front end tends to go in a straight line regardless of how much you turn the steering wheel. On a very slippery surface, you may not be able to steer around a curve or turn. When a front-wheel skid occurs, the only way to stop the skid is to let the vehicle slow down. Stop turning and/or braking so hard. Slow down as quickly as possible without skidding.

Subsections 2.17, 2.18, and 2.19

Test Your Knowledge

1. Stopping is not always the safest thing to do in an emergency. True or False?
2. What are some advantages of going right instead of left around an obstacle?
3. What is an “escape ramp?”
4. If a tire blows out, you should put the brakes on hard to stop quickly. True or False?
5. How do you know if your vehicle has antilock brakes?
6. What is the proper braking technique when driving a vehicle with antilock brakes?
7. How do antilock brakes help you?

These questions may be on the test. If you can't answer them all, re-read subsections 2.17, 2.18, and 2.19.

2.20 ACCIDENT PROCEDURES

When you're in an accident and not seriously hurt, you need to act to prevent further damage or injury. The basic steps to be taken at any accident are to:

- Protect the area.
- Notify the authorities.
- Care for the injured.

2.20.1 Protect the Area

The first thing to do at an accident scene is to keep another accident from happening in the same spot. To protect the accident area:

- If your vehicle is involved in the accident, try to get it to the side of the road. This will help prevent another accident and allow traffic to move.
- If you're stopping to help, park away from the accident. The area immediately around the accident will be needed for emergency vehicles.
- Put on your flashers.
- Set out reflective triangles to warn other traffic. Make sure other drivers can see them in time to avoid the accident.

2.20.2 Notify Authorities

If you have a cell phone or CB, call for assistance before you get out of your vehicle. If not, wait until after the accident scene has been properly protected, then phone or send someone to phone the police. Try to determine where you are so you can give the exact location.

2.20.3 Care for the Injured

If a qualified person is at the accident and helping the injured, stay out of the way unless asked to assist. Otherwise, do the best you can to help any injured parties. Here are some simple steps to follow in giving assistance:

- Don't move a severely injured person unless the danger of fire or passing traffic makes it necessary.
- Stop heavy bleeding by applying direct pressure to the wound.
- Keep the injured person warm.

2.21 FIRES

Truck fires can cause damage and injury. Learn the causes of fires and how to prevent them. Know what to do to extinguish fires.

2.21.1 Causes of Fire

The following are some causes of vehicle fires:

- After Accidents: Spilled fuel, improper use of flares.
- Tires: Under-inflated tires and duals that touch.
- Electrical System: Short circuits due to damaged insulation, loose connections.
- Fuel: Driver smoking, improper fueling, loose fuel connections, leaking fuel tanks and lines.
- Cargo: Flammable cargo improperly sealed, or loaded cargo with poor ventilation.
- Brakes: Truck and/or trailer(s) due to heat generated by excessive braking or locked brakes.

2.21.2 Fire Prevention

Pay attention to the following:

- Pre-trip Inspection: Make a complete inspection of the electrical, fuel, and exhaust systems, tires, and cargo. Be sure to check the fire extinguisher to ensure it is fully charged and appropriately rated for the vehicle driven.
 - Power units used to transport hazardous materials in a quantity that requires placarding must be equipped with a fire extinguisher having a UL rating of 10 B:C or better.
 - Power units that are not used to transport hazardous materials must be equipped with a fire extinguisher having a UL rating of 5 B:C or better, or two 2) fire extinguishers having a UL rating of 4 B:C or more.
- En Route Inspection: Check the tires, wheels, and truck body for signs of heat whenever you stop during a trip.
- Follow Safe Procedures: Follow correct safety procedures for fueling the vehicle, using brakes, handling flares, and other activities that can cause a fire.

- Monitoring: Check the instruments and gauges often for signs of overheating and use the mirrors to look for signs of smoke from tires, brakes, cargo, or the vehicle.
- Caution: Use normal caution in handling anything flammable.

2.21.3 Fire Fighting

Knowing how to fight fires is important. Know how the fire extinguisher works. Study the instructions printed on the extinguisher before you need it. Here are some procedures to follow in case of fire.

Pull Off the Road: The first step is to get the vehicle off the road and stop. In doing so:

- Park in an open area, away from buildings, trees, brush, other vehicles, or anything that might catch fire.
- Don't pull into a service station!
- Notify emergency services of your problem and your location.

Keep the Fire from Spreading: Before trying to put out the fire, make sure that it doesn't spread any further.

- With an engine fire, turn off the engine as soon as you can. Don't open the hood if you can avoid it. Discharge the contents of your fire extinguisher (UL rated B:C or better) through the front grill or under side of the vehicle.
- For a cargo fire in a van or box trailer, keep the doors shut, especially if your cargo contains hazardous materials. Opening the van doors will supply the fire with oxygen and can cause it to burn very fast.

Extinguish the Fire: Here are some rules to follow in putting out a fire:

- When using the extinguisher, stay as far away from the fire as possible.
- Aim at the source or base of the fire, not up in the flames.

Use the Right Fire Extinguisher

- **Tables 2.2 and 2.3** detail the type of fire extinguisher to use by class of fire.
- The “B:C” type fire extinguisher is designed to work on electrical fires and burning liquids.

Class/Type of Fires	
Class	Type
A	Wood, Paper, Ordinary Combustibles Extinguish by Cooling and Quenching Using Water or Dry Chemicals
B	Gasoline, Oil, Grease, Other Greasy Liquids Extinguish by Smothering, Cooling or Heat Shielding Using Carbon Dioxide or Dry Chemicals
C	Electrical Equipment Fires Extinguish with Non-conducting Agents such as Carbon Dioxide or Dry Chemicals. DO NOT USE WATER.
D	Fires in Combustible Metals Extinguish by Using Specialized Extinguishing Powders

Table 2.2

Table 2.3 Classes of Fires and Types of Extinguishers	
Class of Fire/Type of Extinguisher	
Class of Fire	Type of Extinguisher
B or C	Regular Dry Chemical
A, B, C, or D	Multi Purpose Dry Chemical
D	Purple K Dry Chemical
B or C	KCL Dry Chemical
D	Dry Powder Special Compound
B or C	Carbon Dioxide (Dry)
B or C	Halogenated Agent (Gas)
A	Water
A	Water With Anti-Freeze
A or B	Water, Loaded Steam Style
B, some A	Foam

- The “A:B:C” type is designed to work on: burning wood, paper and cloth; electrical fires, and burning liquids.
- Water can be used on wood, paper, or cloth,

but don’t use water on an electrical fire (can cause shock) or a gasoline fire (it will spread the flames).

- A burning tire must be cooled. Lots of water may be required.
- If you’re not sure what to use, especially on a hazardous materials fire, wait for firefighters.
- Position yourself upwind. Let the wind carry the extinguisher to the fire.
- Continue until whatever was burning has been cooled. Absence of smoke or flame does not mean the fire cannot restart.

Subsections 2.20 and 2.21

Test Your Knowledge

1. What are some things to do at an accident scene to prevent another accident?
2. Name two causes of tire fires.
3. What kinds of fires is a “B:C” extinguisher not good for?
4. When using your extinguisher, should you get as close as possible to the fire?
5. Name some causes of vehicle fires.

These questions may be on the test. If you can’t answer them all, re-read subsections 2.20 and 2.21.

2.22 ALCOHOL, OTHER DRUGS, AND DRIVING

2.22.1 Alcohol and Driving

Drinking alcohol and then driving is very dangerous and a serious problem. People who drink alcohol are involved in traffic accidents resulting in over 20,000 deaths every year.

Alcohol impairs muscle coordination, reaction time, depth perception, and night vision. It also affects the parts of the brain that control judgment and inhibition. For some people, one drink is all it takes to show signs of

impairment.

How Alcohol Works: Alcohol goes directly into the blood stream and is carried to the brain. After passing through the brain, a small percentage is removed in urine, perspiration, and by breathing, while the rest is carried to the liver. The liver can only process one-third an ounce of alcohol per hour, which is considerably less than the alcohol in a standard drink. This is a fixed rate, so only time, not black coffee or a cold shower, will sober you up. If you have drinks faster than your body can get rid of them, you will have more alcohol in your body, and your driving will be more affected. The Blood Alcohol Content (BAC) commonly measures the amount of alcohol in your body (See Table 2.4).

Effects Of Increasing Blood Alcohol Content		Table 2.4
Blood Alcohol Content is the amount of alcohol in your blood recorded in milligrams of alcohol per 100 milliliters of blood. Your BAC depends on the amount of blood (which increases with weight) and the amount of alcohol you consume over time (how fast you drink). The faster you drink, the higher your BAC, as the liver can only handle about one drink per hour—the rest builds up in your blood.		
BAC	Effects on Body	Effects on Driving Condition
.02	Mellow feeling, slight body warmth.	Less inhibited.
.05	Noticeable relaxation.	Less alert, less self-focused, coordination impairment begins.
.08	Definite impairment in coordination & judgment .	Drunk driving limit, impaired coordination & judgment.
.10*	Noisy, may exhibit embarrassing behavior, mood swings.	Reduction in reaction time.
.15	Impaired balance & movement, clearly drunk.	Unable to drive.
.30	Many lose consciousness.	
.40	Most lose consciousness, some die.	
.50	Breathing stops, many die.	
BAC of .10 means that 1/10 of 1 % (or 1/1000) of your total blood content is alcohol.		

What Is a Drink? It is the alcohol in drinks that affects human performance. It doesn't make any difference whether that alcohol comes from "a couple of beers," or from two glasses of wine, or two shots of hard liquor.

All of the following drinks contain the same amount of alcohol:

- A 12-ounce glass of 5% beer.
- A 5-ounce glass of 12% wine.
- A 1.5-ounce shot of 80 proof liquor (40% alcohol).

What Determines Blood Alcohol Content? BAC is determined by the amount of alcohol you drink (more alcohol means higher BAC), how fast you drink (faster drinking means higher BAC), and your weight (a small person doesn't have to drink as much to reach the same BAC).

Alcohol and the Brain: Alcohol affects more and more of the brain as BAC builds up. The first part of the brain affected controls judgment and self-control. One of the bad things about this is it can keep drinkers from knowing they are getting drunk, and, of course, good judgment and self-control are absolutely necessary for safe driving.

As BAC continues to build up, muscle control, vision, and coordination are affected more and more. Effects on driving may include:

- Straddling lanes.
- Quick, jerky starts.
- Not signaling, failure to use lights.
- Running stop signs and red lights.
- Improper passing.

These effects mean increased chances of a crash and excellent chances for being arrested and losing your driver's license. Accident statistics show that the chance of a crash is much greater for drivers who have been drinking than for drivers who have not.

Blood Alcohol Content is the amount of alcohol in your blood recorded in milligrams of alcohol per 100 millimeters of blood or milligrams. Your BAC depends on the amount of blood (which increases with weight) and the amount of alcohol you consume over time (how fast you drink). The faster you drink, the higher your BAC, as the liver can only handle about one drink per hour - the rest builds up in your blood (See Table 2.5).

As BAC continues to build, It is the alcohol in drinks that affects human performance. It doesn't make any difference whether that alcohol comes from "a couple of beers," or from two glasses of wine, or two shots of hard liquor. Approximate Blood Alcohol Content

Drinks ↓	Body Weight in Pounds									Effects ↓
	100	125	150	175	200	225	250	275	300	
0	.00	.00	.00	.00	.00	.00	.00	.00	.00	Only Safe Driving Limit
1	.04	.03	.03	.02	.02	.02	.02	.02	.02	Impairment Begins
2	.08	.06	.05	.05	.04	.04	.03	.03	.03	Driving Skills Significantly Affected Criminal Penalties
3	.11	.09	.08	.07	.06	.06	.05	.05	.05	
4	.15	.12	.11	.09	.08	.08	.07	.06	.06	
5	.19	.16	.13	.12	.11	.09	.09	.08	.08	
6	.23	.19	.16	.14	.13	.11	.10	.09	.09	Legally Intoxicated Criminal Penalties
7	.26	.22	.19	.16	.15	.13	.12	.11	.11	
8	.30	.25	.21	.19	.17	.15	.14	.13	.13	
9	.34	.28	.24	.21	.19	.17	.15	.14	.14	
10	.38	.31	.27	.23	.21	.19	.17	.16	.16	

Subtract .01% for each 40 minutes of drinking. One drink is 1.25 oz. of 80 proof liquor, 12 oz. of beer, or 5 oz. of table wine.

Table 2.5

How Alcohol Affects Driving: All drivers are affected by drinking alcohol. Alcohol affects judgment, vision, coordination, and reaction time. It causes serious driving errors, such as:

- Increased reaction time to hazards.
- Driving too fast or too slow.
- Driving in the wrong lane.
- Running over the curb.
- Weaving.

2.22.2 Other Drugs

Besides alcohol, other legal and illegal drugs are being used more often. Laws prohibit possession or use of many drugs while on duty. They prohibit being under the influence of any "controlled substance," amphetamines (including "pep pills," "uppers," and "bennies"), narcotics, or any other substance, which can make the driver unsafe. This could include a variety of prescription and over-the-counter drugs (cold medicines), which may make the driver drowsy or otherwise affect his/her safe driving ability. However, possession and use of a drug given to a driver by a doctor is permitted if the doctor informs the driver that it will not affect his/her safe driving ability.

Pay attention to warning labels for legitimate drugs and medicines, and to doctor's orders regarding possible side effects of the drug. Stay away from illegal drugs.

Don't use any drug that hides fatigue - the only cure for fatigue is rest. Alcohol can make the effects of other drugs much worse. The safest rule is don't mix drugs with driving at all.

Use of drugs can lead to traffic accidents resulting in death, injury, and property damage. Furthermore, it can lead to arrest, fines, and jail sentences. It can also mean the end of a person's driving career.

2.23 STAYING ALERT AND FIT TO DRIVE

Driving a vehicle for long hours is tiring. Even the best of drivers will become less alert. However, there are things that good drivers do to help stay alert and safe.

2.23.1 Be Ready to Drive

Get Enough Sleep: Sleep is not like money. You can't save it up ahead of time and you can't borrow it later; however, just as with money, you can go into debt with it. If you don't sleep enough, you "owe" more sleep to yourself. This debt can only be paid off by sleeping. You can't overcome it with willpower, and it won't go away by itself. The average person needs seven or eight hours of sleep every 24 hours. Leaving on a long trip when you're already tired is dangerous. If you have a long trip scheduled, make sure that you get enough sleep before you go.

Schedule Trips Safely: Try to arrange your schedule so you are not in "sleep debt" before a long trip. Your body gets used to sleeping during certain hours. If you are driving during those hours, you will be less alert. If possible, try to schedule trips for the hours you are normally awake. Many heavy motor vehicle accidents occur between midnight and 6 a.m. Tired drivers can easily fall asleep at these times, especially if they don't regularly drive at those hours. Trying to push on and finish a long trip at these times can be very dangerous.

Exercise Regularly: Resistance to fatigue and improved sleep are among the benefits of regular exercise. Try to incorporate exercise into your daily life. Instead of sitting and watching TV in your sleeper, walk or jog a few laps around the parking lot. A little bit of daily exercise will give you energy throughout the day.

Eat Healthy: It is often hard for drivers to find healthy food, but with a little extra effort, you can eat healthy, even on the road. Try to find restaurants with healthy, balanced meals. If you must eat at fast-food restaurants, pick low-fat items. Another simple way to reduce your caloric intake is to eliminate fattening snacks. Instead, try fruit or vegetables.

Avoid Medication: Many medicines can make you sleepy, and those that do usually have a label warning against operating vehicles or machinery. The most common medicine of this type is an ordinary cold pill. If you have to drive with a cold, you are better off suffering from the cold than from the effects of the medicine.

Visit Your Doctor: Regular checkups literally can be lifesavers. Illnesses such as diabetes, heart disease, and

skin and colon cancer can be detected easily and treated if found in time.

You should consult your physician or a local sleep disorder center if you suffer from frequent daytime sleepiness, have difficulty sleeping at night, take frequent naps, fall asleep at strange times, snore loudly, gasp and choke in your sleep, and/or wake up feeling as though you have not had enough sleep.

2.23.2 While You Are Driving

Keep Cool: A hot, poorly ventilated vehicle can make you sleepy. Keep the window or vent cracked open or use the air conditioner if you have one.

Take Breaks: Short breaks can keep you alert, but the time to take them is before you feel really drowsy or tired, not after. Stop often and walk around and inspect your vehicle. It may help to do some physical exercises. Be sure to take a mid-afternoon break and plan to sleep between midnight and 6 a.m.

Recognize the Danger Signals of Drowsy Driving. Sleep is not voluntary. If you're drowsy, you can fall asleep and never even know it. If you are drowsy, you are likely to have "micro sleeps" - brief naps that last around four or five seconds. At 55 miles an hour, that's more than 100 yards, and plenty of time for a crash. Even if you are not aware of being drowsy, if you have a sleep debt you are still at risk. Here are a few ways to tell if you're about to fall asleep. If you experience any of these danger signs, take them as a warning that you could fall asleep without meaning to.

- Your eyes close or go out of focus by themselves.
- You have trouble keeping your head up.
- You can't stop yawning.
- You have wandering, disconnected thoughts.
- You don't remember driving the last few miles.
- You drift between lanes, tailgate, or miss traffic signs.
- You keep jerking the truck back into the lane.
- You have drifted off the road and narrowly missed crashing.

If you have even one of these symptoms, you may be in danger of falling asleep. Pull off the road in a safe place and take a nap.

2.23.3 When You Do Become Sleepy

When you are sleepy, trying to “push on” is far more dangerous than most drivers think. It is a major cause of fatal accidents. Here are some important rules to follow.

Stop to Sleep: When your body needs sleep, sleep is the only thing that will work. If you have to make a stop anyway, make it whenever you feel the first signs of sleepiness, even if it is earlier than you planned. By getting up a little earlier the next day, you can keep on schedule without the danger of driving while you are not alert.

Take a Nap: If you can’t stop for the night, at least pull off at a safe place, such as a rest area or truck stop, and take a nap. A nap as short as a half-hour will do more to overcome fatigue than a half-hour coffee stop.

Avoid Drugs: There are no drugs that can overcome being tired. While they may keep you awake for a while, they won’t make you alert, and eventually, you’ll be even more tired than if you hadn’t taken them at all. Sleep is the only thing that can overcome fatigue.

Do Not: Don’t rely on coffee or another source of caffeine to keep you awake. Do not count on the radio, an open window, or other tricks to keep you awake.

2.23.4 Illness

Once in a while, you may become so ill that you cannot operate a motor vehicle safely. If this happens to you, you must not drive; however, in case of an emergency, you may drive to the nearest place where you can safely stop.

2.24 HAZARDOUS MATERIALS RULES FOR ALL COMMERCIAL DRIVERS

All drivers should know something about hazardous materials. You must be able to recognize hazardous cargo, and you must know whether or not you can haul it without having a hazardous materials endorsement on your license.

2.24.1 What Are Hazardous Materials?

Hazardous materials are products that pose a risk to health, safety, and property during transportation (See Table 2.6)









Hazard Class Definitions		
Class	Class Name	Example
1	 Explosives	Ammunition, Dynamite, Fireworks
2	 Gases	Propane, Oxygen, Helium
3	 Flammable	Gasoline Fuel, Acetone
4	 Flammable Solids	Matches, Fuses
5	 Oxidizers	Ammonium Nitrate, Hydrogen Peroxide
6	 Poisons	Pesticides, Arsenic
7	 Radioactive	Uranium, Plutonium
8	 Corrosives	Hydrochloric Acid, Battery Acid
9	 Miscellaneous Hazardous Materials	Formaldehyde, Asbestos
None	ORM-D (Other Regulated Material-Domestic)	Hair Spray or Charcoal
None	Combustible Liquids	Fuel Oils, Lighter Fluid

Table 2.6

2.24.2 Why Are There Rules?

You must follow the many rules about transporting hazardous materials. The intent of the rules is to:

- Contain the product.
- Communicate the risk.
- Ensure safe drivers and equipment.

To Contain the Product: Many hazardous products can injure or kill on contact. To protect drivers and others from contact, the rules tell shippers how to package safely. Similar rules tell drivers how to load, transport, and unload bulk tanks. These are containment rules.

To Communicate the Risk: The shipper uses a shipping paper and diamond shaped hazard labels to warn dockworkers and drivers of the risk.

After an accident or hazardous material spill or leak, you may be injured and unable to communicate the hazards of the materials you are transporting. Firefighters and police can prevent or reduce the amount of damage or injury at the scene if they know what hazardous materials are being carried. Your life, and the lives of others, may depend on quickly locating the hazardous materials shipping papers. For that reason, you must tab shipping papers related to hazardous materials or keep them on top of other shipping papers. You must also keep shipping papers:

- In a pouch on the driver's door, or
- In clear view within reach while driving, or
- On the driver's seat when out of the vehicle.

2.24.3 Lists of Regulated Products

Placards are used to warn others of hazardous materials. Placards are signs put on the outside of a vehicle that identify the hazard class of the cargo. A placarded vehicle must have at least four identical placards. They are put on the front, rear, and both sides. Placards must be readable from all four directions. They are at least 10 3/4 inches square, turned upright on a point, in a diamond shape. Cargo tanks and other bulk packaging display the identification number of their contents on placards or orange panels.

Identification Numbers are a four digit code used by first responders to identify hazardous materials. An identification number may be used to identify more

than one chemical on shipping papers. The identification number will be preceded by the letters "NA" or "UN." The U.S. DOT Emergency Response Guidebook (ERG) identifies the chemicals to which all identification numbers are assigned.

Not all vehicles carrying hazardous materials need to have placards. The rules about placards are given in Chapter 9 of this manual. You can drive a vehicle that carries hazardous materials if it does not require placards. If it requires placards, you cannot drive it unless your driver's license has the hazardous materials endorsement (**See Figure 2.19**).

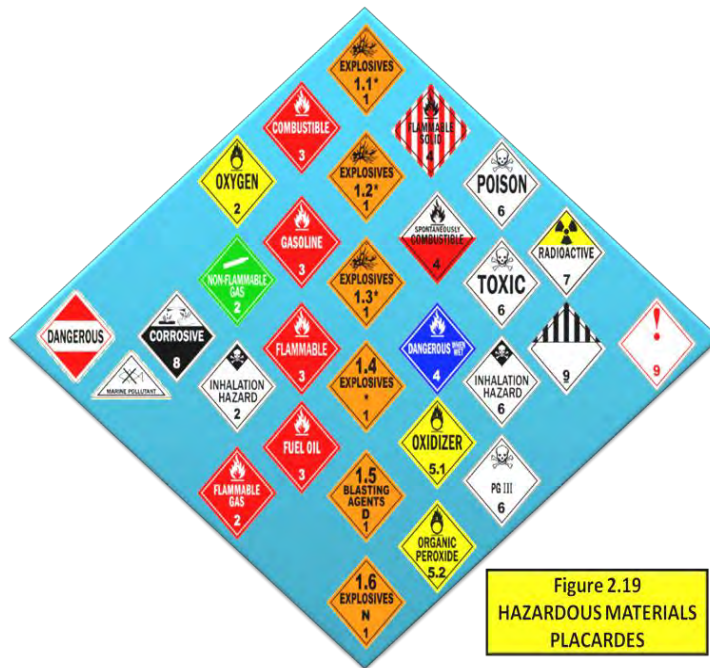

The rules require all drivers of placarded vehicles to learn how to safely load and transport hazardous products. They must have a commercial driver's license with a hazardous materials endorsement. To get the required endorsement, you must pass a written test on material found in Chapter 9 of this manual. A tank endorsement is required for certain vehicles that transport liquids or gases. The liquid or gas does not have to be a hazardous material. A tank endorsement is only required if your vehicle needs a Class A or B CDL, and your vehicle has a permanently mounted cargo tank of any capacity; or your vehicle is carrying a portable tank with a capacity of 1,000 gallons or more.

Drivers who need the hazardous materials endorsement must learn the placard rules. If you do not know if your vehicle needs placards, ask your employer. Never drive a vehicle needing placards unless you have the hazardous materials endorsement. To do so is a crime.

When stopped you will be cited and you will not be allowed to drive your truck further. It will cost you time and money. A failure to placard when needed may risk your life and others if you have an accident. Emergency help will not know of your hazardous cargo.

Hazardous materials drivers must also know which products they can load together, and which they cannot. These rules are also in Chapter 9. Before loading a truck with more than one type of product, you must know if it is safe to load them together. If you do not know, ask your employer.

Subsections 2.22, 2.23, and 2.24

Test Your Knowledge

1. Common medicines for colds can make you sleepy. True or False?
2. What should you do if you become sleepy while driving?
3. Coffee and a little fresh air will help a drinker sober up. True or False?
4. What is a hazardous materials placard?
5. Why are placards used?
6. What is "sleep debt"?
7. What are the danger signals of drowsy driving?

These questions may be on the test. If you can't answer them all, re-read subsections 2.22, 2.23, and 2.24.

2.25 SHARING THE ROAD

2.25.1 Introduction.



As a professional driver, you will be faced with the daily challenges of driving a large heavy commercial vehicle in several different traffic and weather environments. Traffic is of constant concern to the commercial vehicle driver, so he/she must pay specific attention to the

limitations and characteristics of the equipment they

operate (i.e., off-tracking, visibility blind spots – **The No Zone**, See **Figure 2.20**, acceleration and stopping characteristics of the vehicle, etc.).

The commercial driver must also be concerned with the effects their equipment may have (i.e., air turbulence, spray, flying debris, etc.) on others sharing the road or being next to it (i.e., smaller vehicles, motorcycles, bicycles and pedestrians).

The keys to minimizing hazards to others you share the roadway with are:

- Patience
- Courtesy
- Respect for the rights of others
- Heightened awareness of potential problems
- Abundance of caution

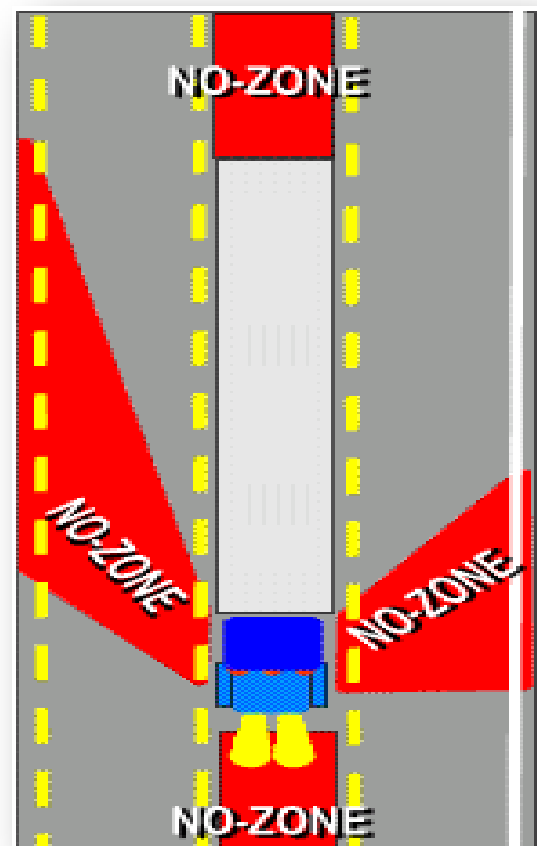

Figure 2.20

2.25.2 Motorcycles



Motorcycle riders have the same rights and responsibilities as other highway users, and they must obey the same traffic laws. Motorcycles are smaller and harder to see than cars. They're easily hidden in a commercial vehicle's blind spot. Because it may be hard to judge the distance to motorcycles, or to tell how fast they are moving, be alert to their presence and be extra cautious. Approximately one-half of all motorcycle crashes involve another motor vehicle, so it is important to practice safe driving in order to help avoid collisions. Here are some situations that call for special attention when motorcycles are around.

Left turns: Vehicles turning left in front of an oncoming motorcycle cause nearly 40 percent of serious car/motorcycle crashes. Drivers may fail to see a motorcycle rider in the traffic scene, or a driver may fail to judge the speed of an oncoming motorcycle. As a driver, the correct precaution is for you to look and then look again. Make sure you see the motorcycle and know its speed before you make a left turn.

Turn signals: Most motorcycles do not have turn signals that turn off automatically. At times, motorcycle riders may forget to switch the signal off. Before you make a turn in front of a motorcycle with a signal flashing, be sure the motorcycle is turning and not continuing straight into your path.

Lanes: Motorcycles are entitled to the same full lane width as all other vehicles. Good motorcycle riders are constantly changing positions within the lane so they can see and be seen, and to avoid objects in the road. Never move into the same lane alongside a motorcycle, even if the lane is wide and the motorcyclist is riding far to one side.

Bad weather: Weather conditions and slippery surfaces can be serious problems for motorcycles. Allow even

more following room when it's raining or the road surface is slick.

Road surface: Unusual road surfaces and irregularities in the road that don't affect other vehicles can create problems for motorcycles. Gravel, debris, pavement seams, small animals, and even manhole covers may force a motorcycle rider to change speed or direction.

Visibility: Always make a visual check for motorcycles by checking mirrors and blind spots before entering or leaving a lane of traffic or an intersection. Motorcyclists are often hidden in a vehicle's blind spot or missed in a quick look due to their smaller size. Always use turn signals and brake lights to signal your intentions for turning, changing lanes, merging, slowing and stopping. This allows the motorcyclist to anticipate traffic flow and find a safe lane position. Allow more than 3 seconds following distance between your vehicle and the motorcycle. This allows you and the motorcyclist enough time to maneuver or stop in an emergency.

2.25.3 Bicyclists



Every year the number of bicycles increases on Idaho roadways. Cycling has become an important means of transportation as well as recreation. Bicyclists are legally allowed to ride on all Idaho roadways, have the same rights as motorists, and are required to ride with the flow of traffic. They must ride as close to the right-hand curb or edge of the roadway as safety allows, except when passing, turning left, avoiding an obstacle, or when the roadway does not allow a bicycle and vehicle to travel safely side by side.

In Idaho, cyclists do not need to come to a complete stop at stop signs. They must, however, yield the right-of-way to vehicles in or already at the intersection, and then proceed with caution through the intersection. Bicyclists may proceed with caution through a red light after stopping and yielding the right of way to vehicles already in the intersection. They do not need to come to a complete stop when turning right on a red light; however, they must yield the right of way to vehicles already in the intersection.

Cyclists are relatively unprotected compared to motor vehicle operators and most collisions result in injury to the cyclist; therefore, motor vehicle operators should be alert and use caution when encountering them.

The following are some rules you must observe when operating your vehicle around cyclists:

- **RIGHT TURNS WHEN STOPPED:** When stopped, never only look to the left before turning right. Always look both left and right, checking the right first. A cyclist riding against traffic or on the sidewalk may be approaching on your right. Also, a cyclist may be pulled up alongside to turn right. A crash is easily preventable if you look both directions before turning.
- **RIGHT TURNS WHEN MOVING:** If you are preparing for a right turn and a bicyclist is ahead of you, do not assume that you can beat the bicycle to the turn. Misjudgment can result in a broadside crash called the "right hook." Avoid right-hook crashes by slowing and remaining behind the bicyclist until he rides past the point where you will turn. On streets with bike lanes, remember that you are turning across a dedicated travel lane. Always look for and expect bicyclists.
- **INTERSECTIONS:** When proceeding through or turning at an intersection, always scan the corners of the intersection more than once. An approaching cyclist can easily travel 50 to 100 feet in a few seconds, so what you saw on your first look may change. Looking one last time before proceeding is a good safety practice.
- **DASHED BIKE LANE LINES:** Dashed lines indicate a merging movement is allowed and expected. Check for bicyclists first. When turning right at an intersection it is OK to occupy the bike lane in the dashed line area. This prevents cyclists from approaching along your right side and forces them to blend into the lane of traffic that will best suit their intentions when going through the intersection.
- **SIDEWALKS:** Bicyclists can legally ride on sidewalks in most communities although there is no legal requirement to use them. Young children usually ride on the sidewalk, so be extremely cautious when pulling in or out of a driveway.
- **CHILDREN:** Be aware that children riding along the street often change direction unexpectedly, so pass them with extra caution and distance.
- **BEING IN A HURRY:** Never rush a turn or squeeze past a bicyclist just to beat traffic or a traffic light. The few seconds you are trying to save may cost a life.
- **EXPECT BICYCLISTS:** Bicyclists are not as noticeable as motor vehicles. Their position on the road, smaller size, and slower speed requires drivers to consciously look for them. Always drive with the expectation that bicyclists are on the road.
- **PASSING DISTANCE:** A typical 12-foot-wide travel lane is not wide enough to safely share with a bicyclist. Cycling instructors and riding manuals teach bicyclists to ride at least 3 feet from the edge of pavement to avoid accumulated edge debris and have enough space to the right, away from traffic, for an emergency maneuver. Three feet is the minimum passing space that motorists should leave when passing a bicyclist. Higher speeds require more passing space. Always wait until you can see oncoming traffic and then safely pass by moving partially or fully into the other lane. This delay is usually brief.
- **BE PATIENT:** The design of some streets and highways requires that for safety bicyclists must occupy the travel lane by riding in the center, not to the right. Do not tailgate the bicyclist. These are usually brief stretches of narrow roadway where it is unsafe for a motorist to pass a bicyclist.
- **COMMUNICATION:** If you want to make sure a bicyclist sees you, wave a hand or nod your head, and wait for the bicyclist's reaction. Do not depend on making "eye contact."
- **HONKING:** Never honk when close to a bicyclist, it is startling.
- **PARALLEL PARKING:** Always look behind you for approaching bicyclists before opening the driver's door.
- **BE PREDICTABLE:** Road safety depends upon predictability. Always use your turn signal.

Bicyclists and other motorists will appreciate knowing your intent to turn or change lanes.

➤ **BIKE LANES:** Parking in bike lanes is not allowed. These are designated travel lanes for bicyclists and should not be blocked.

➤ **YIELD TO CYCLISTS:**

- Bicycles are considered vehicles
- Cyclists should be given the appropriate right of way
- Allow extra time for cyclists to traverse intersections



➤ **PASS WITH CARE:**

- Check your mirrors carefully before moving back
- The wind produced by your vehicle could cause a cyclist to swerve out of control.
- In wet weather, try to stay to the far side of the lane in order not to splash water or spray the cyclist.

➤ **INFORMATION PAMPHLETS:** *Idaho Bicycling Street Smarts* and the *Idaho Bicycle Commuter Guide* are available from the Idaho Transportation Department. You may order copies from the website at

http://www.itd.idaho.gov/bike_ped/Commuter_StreetSmarts.html or check with your County driver's license office for a copy.



2.25.4 Pedestrians

Vehicle-pedestrian collisions account for approximately 12 percent of all traffic deaths. When driving a commercial vehicle, you must be aware of pedestrian activity, particularly in residential areas, near schools, school crossings, trail crossings, parking lots, intersections, crosswalks, bus stops, playgrounds, and parks.

You always need to be alert and use caution when driving near pedestrians. Pedestrians are unpredictable and highly vulnerable to injury.

2.25.5 Children at Play

Take extra care when driving in residential areas and school zones and at times and places where children are likely to be found near the roadway. Before getting into your vehicle, walk around it to be sure no children are playing near it that you may not be able to see from the driver's seat. When backing out of a driveway, watch for children who may run behind your vehicle. **OBEY**



THE SPEED LIMIT and be alert when vehicles are parked along the roadway. Darting into traffic from between or around a parked car is a common cause of serious injury to children. They are often too short to be seen easily when playing near parked cars, so use extra caution when you

see any children near the roadway. They may have an unseen playmate that cannot see you either.

2.25.6 Horseback Riders

People riding horses are allowed to use most public roads. They also have the same rights as motor vehicle operators and must obey the same rules. When approaching someone riding a horse, take care to avoid frightening the animal—slow down and allow plenty of room when passing. Never sound your horn because



you may frighten the horse and cause an accident. If you encounter a rider that is having difficulty controlling an animal, be sure to use extreme caution when going around them. Stop if necessary to prevent becoming a part of the hazard.

2.25.7 Funeral Processions

If you see a funeral procession on the road, do not drive between or join vehicles in the formation unless you are authorized to do so by a police officer. Do not pass the procession in the right lane on a multi-lane highway unless the procession is in the farthest left lane. You may not enter an intersection when the procession is proceeding through (regardless of the color of the traffic light) unless you can do so without crossing the path of the procession. Always give funeral processions the right of way.

All vehicles in a funeral procession are required to have their headlights and tail lights turned on. The first and last vehicles in the procession must also have their warning lights flashing to indicate the beginning and ending points of the formation.



2.25.8 Open Range

Horses, cattle, sheep, goats, and other livestock that are under controlled movement over a highway or road have the right of way in Idaho. When you meet or overtake any livestock herds, be careful and cooperate with the workers in charge.

Livestock also run at large in much of Idaho's range country, and they have the right of way. Drivers must be alert for animals grazing unattended on "open range," which means almost all areas outside of city



limits and herd districts upon which livestock by custom, license, lease, or permit, are grazed or permitted to roam. The presence of fences does not necessarily mean that animals are not present or do not have the right of way.

Be especially careful driving at night. If you strike and injure or kill livestock or domestic animals that are on the open range or under controlled movement, the owner of the animal(s) is not liable for damages to you or your vehicle; however, you may be liable for the injuries or death of the animal if you are found to have been negligent.

2.26 IDAHO PORT OF ENTRY INFORMATION

Special Note: The following is for information purposes only. You will not be tested on the contents of section 2.26.

2.26.1 Port Of Entry:

Laws regarding the establishment and stopping requirements at the Idaho Ports of Entry are found in Idaho Code §40-510 & §40-511.

2.26.2 Gross Weight

Means the weight of a vehicle without load plus the weight of any load on that vehicle. (Idaho Code §49-108(4))

2.26.3 Maximum Gross Weight

Idaho Code §49-114 (6)

Means the scale weight of a vehicle, equipped for operation, to which shall be added the maximum load to be carried as declared by the owner in making application for registration. When a vehicle against which a registration fee is assessed is a combination of vehicles, the “maximum gross weight” means the combined maximum gross weights of all vehicles in the combination.



Laws governing Idaho Allowable Weight limits are found in Idaho Code §49-1001. The weight limits vary depending on the commodity being hauled and the routes being traveled. General weight limits are as follows:

Single Axle: 20,000 lbs.

Tandem axles:

34,000 lbs. (Interstate System-- Refer to bridge formula §49-1001(1))

37,800 lbs. (Interstate System--gross weight is limited to 79,000 lbs. hauling exempt commodities – logs, pulpwood, stull, poles or pilings, ores, concentrates, sand & gravel, and aggregates thereof, in bulk; unprocessed agricultural products including livestock. Refer to §49-1001(2)).

37,800 lbs. (Non-Interstate System. Gross weight limited to 80,000 lbs. Refer to §49-1001(9)).

Maximum Weight on Interstate without an Over-legal Permit:

80,000 lbs.

Maximum Weight on Interstate with an Over-legal Permit:

105,500 lbs.

Maximum Weight on Secondary Routes (no Over-legal permit required):

105,500 lbs.

Certain routes can accommodate loads up to 129,000 lbs. with an Overlegal permit.

See <http://itd.idaho.gov/dmv/poe/poe.htm> online for more information

2.26.4 Who Must Stop:

Idaho requires any Commercial Motor Vehicle (CMV) with a Maximum Gross Weight or Registered Gross Weight of 26,001 lbs. or more to stop and submit to weighing and inspection at all established Idaho Ports of Entry, this includes roving ports of entry set up at various locations through the state.

Idaho also requires any vehicle, or combinations of vehicles, with a Maximum Gross Weight of 10,000 pounds or more transporting livestock or placardable quantities of hazardous materials to stop at all ports of entry or checking stations established by the Idaho Transportation Department.

2.26.5 Size Limitations

See chart on next page

2.26.6 Weight Limits:

2.26.5 Size Limitations

Laws governing Idaho size limitations are found in Idaho Code §49-1010.

LEGAL DIMENSIONS ARE AS FOLLOWS:

Width: 8ft. 6in. (102")

Height: 14 ft.

Length:

Single motor vehicle	45'
Trailer or Semi-Trailer (Off National Network)	48'
Trailer or Semi-Trailer (On National Network)	53'
Motor Vehicle with One or more Trailers (except as noted below)	75'
Double Trailers (Off National Network)	61' of trailers or 75' overall
Double Trailers (On National Network)	68 ft. of trailers
Dromedary Tractor (Stinger Steered)	75 ft.
Dromedary Tractor (Non-stinger Steered)	65 ft.
Auto or Boat Transporter (Stinger Steered)	75 ft.
Auto or Boat Transporter (Non-stinger steered)	65 ft.
Saddle-mount Combinations (On National Network)	97 ft.
Saddle-mount Combinations (Off National Network)	75 ft.
Overhang:	
Front of Vehicle	4'
Beyond the end of a vehicle	10'
Front and Read combined overhang for Auto or Boat Transporter	7'



The national network is defined as the interstate system and routes designated as such on the Extra-Length Map which the Idaho Over-legal Permit office maintains.

Other size limitations exist in Idaho code and for loads exceeding these limitations, see Idaho Over-legal Permit Conditions Manual. <http://itd.idaho.gov/dmv/poe/documents/permits.pdf>

Chapter 3 : Transporting Cargo Safely

This Chapter Covers:



- Inspecting Cargo**
- Cargo Weight and Balance**
- Securing Cargo**
- Cargo Needing Special Attention**

This chapter tells you about hauling cargo safely. You must understand basic cargo safety rules to get a CDL.

If you load cargo wrong or do not secure it, it can be a danger to others and yourself. Loose cargo that falls off a vehicle can cause traffic problems and others could be hurt or killed. Loose cargo could hurt or kill you during a quick stop or crash. Your vehicle could be damaged by an overload. Steering could be affected by how a vehicle is loaded, making it more difficult to control the vehicle.

Whether or not you load and secure the cargo yourself, you are responsible for:

- Inspecting your cargo.
- Recognizing overloads and poorly balanced weight.
- Knowing your cargo is properly secured and does not obscure your view ahead or to the sides.
- Knowing your cargo does not restrict your access to emergency equipment.

Exception to the inspection rule: Per Federal Motor Carrier Rule 392.9 (b) (4) you are not responsible for inspecting the cargo of a commercial motor vehicle and/or trailer, if it bears a “Seal” and you are ordered not to open the unit and inspect the cargo. You are also not responsible for inspecting the cargo of a commercial motor vehicle and/or trailer if the cargo is loaded in such a manner that makes an inspection impracticable (such as a container).

If you intend to carry hazardous material that requires placards on your vehicle, you will also need to have a hazardous materials endorsement. Chapter 9 of this

manual has the information you need to pass the hazardous materials test.

3.1 INSPECTING CARGO

As part of your pre-trip inspection, make sure the truck is not overloaded and the cargo is balanced and secured properly.

After Starting the Trip: Inspect the cargo and its securing devices again within the first 50 miles after beginning a trip. Make any adjustments needed.

Re-check: Re-check the cargo and securing devices as often as necessary during a trip to keep the load secure. A good habit is to inspect again:

- After you have driven for 3 hours or 150 miles.
- After every break you take during driving.

Federal, state, and local regulations for commercial vehicle weight, securing cargo, covering loads, and where you can drive large vehicles vary from place to place. Know the rules where you will be driving.

3.2 WEIGHT AND BALANCE

You are responsible for not being overloaded. The following are some definitions of weight you should know.

3.2.1 Definitions You Should Know

Gross Vehicle Weight (GVW): The total weight of a single vehicle plus its load.

Gross Combination Weight (GCW): The total weight of a powered unit, plus trailer(s), plus the cargo.

Gross Vehicle Weight Rating (GVWR): The maximum Gross Vehicle Weight specified by the manufacturer for a single vehicle plus its load. This is also called the placarded weight and is on plate attached to the truck/tractor and trailer(s).

Gross Combination Weight Rating (GCWR): The maximum Gross Combination Weight specified by the

manufacturer for a specific combination of vehicles plus its load.

Axle Weight: The weight transmitted to the ground by one axle or one set of axles.

Tire Load: The maximum safe weight a tire can carry at a specified pressure. This rating is stated on the side of each tire.

Suspension Systems: Suspension systems have a manufacturer's weight capacity rating.

Coupling Device Capacity: Coupling devices are rated for the maximum weight they can pull and/or carry.

3.2.2 Legal Weight Limits

You must keep weights within legal limits. States have maximums for GVWs, GCWs, and axle weights. Often, maximum axle weights are set by a bridge formula. A bridge formula permits less maximum axle weight for axles that are closer together. This is to prevent overloading bridges and roadways.

Overloading can have bad effects on steering, braking, and speed control. Overloaded trucks have to go very slowly on upgrades, and they may gain too much speed on downgrades. Stopping distance increases and brakes can fail when forced to work too hard. During bad weather or in mountains, it may not be safe to operate at legal maximum weights. Take this into account before driving.

3.2.3 Don't Be Top-heavy

The height of the vehicle's center of gravity is very important for safe handling. A high center of gravity (cargo piled up high or heavy cargo on top) means you are more likely to tip over. It is most dangerous in curves, or if you have to swerve to avoid a hazard. It is very important to distribute the cargo so it is as low as possible. Put the heaviest parts of the cargo under the lightest parts.

3.2.4 Balance the Weight

Poor weight balance can make vehicle handling unsafe. Too much weight on the steering axle can cause hard steering. It can damage the steering axle and tires. Under-loaded front axles (caused by shifting weight too far to the rear) can make the steering axle weight too

light to steer safely. Too little weight on the driving axles can cause poor traction and cause the drive wheels to spin more easily. During bad weather, the truck may not be able to keep going. Weight that is loaded so there is a high center of gravity causes a greater chance of rollover. On flat bed vehicles, there is also a greater chance that the load will shift to the side or fall off (See Figure 3.1).

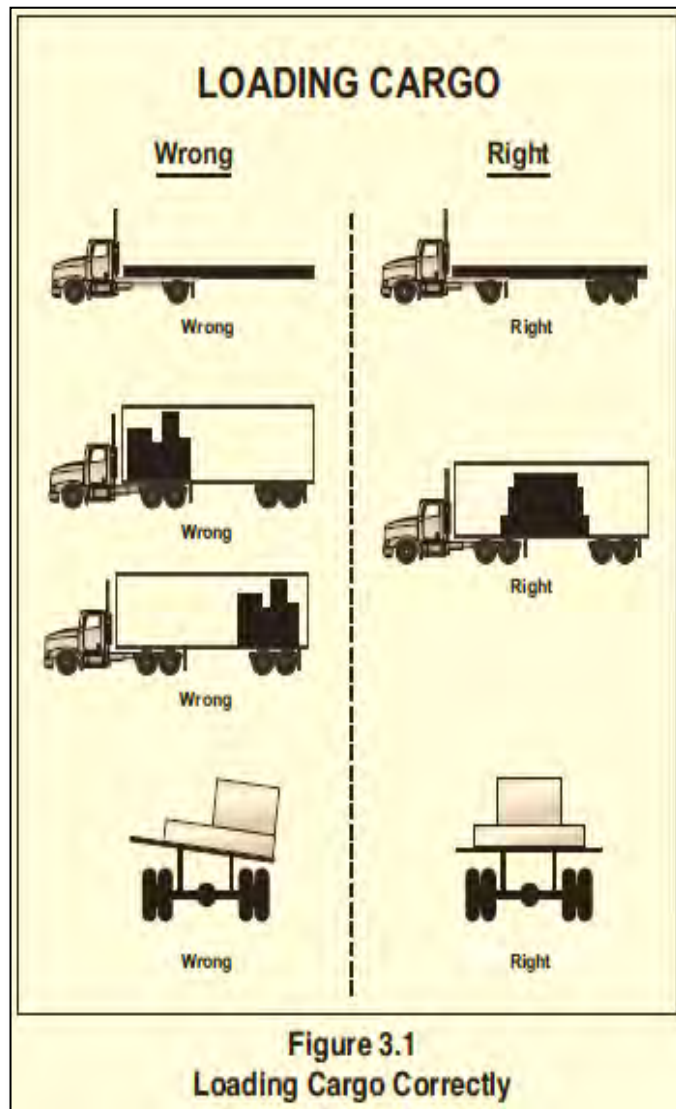

3.3 SECURING CARGO

3.3.1 Blocking and Bracing

Blocking (also known as dunnage) is used in the front, back, and/or sides of a piece of cargo to keep it from sliding. Blocking is shaped to fit snugly against cargo. It is secured to the cargo deck to prevent cargo movement. Bracing is also used to prevent movement of cargo. Bracing goes from the upper part of the cargo to the floor and/or walls of the cargo compartment.

3.3.2 Cargo Tie-down

On flatbed trailers or trailers without sides, cargo must be secured to keep it from shifting or falling off.



In closed vans, tie-downs can also be important to prevent cargo shifting that may affect the handling of the vehicle. Tie-downs must be of the proper type and proper strength.

The combined strength of all cargo tie-downs must be strong enough to lift one and one-half times the weight of the piece of cargo tied down. Proper tie-down equipment must be used, including ropes, straps, chains, and tensioning devices (winches, ratchets, clinching components). Tie-downs must be attached to the vehicle correctly (hooks, bolts, rails, rings). See **Figure 3.2 and 3.2a**.

meet this need. No matter how small the cargo, it should have at least two tie-downs.

TIE-DOWN DEVICES

Cargo should have at least one tie-down for each 10 feet of cargo. Make sure you have enough tie-downs to meet this need. No matter how small the cargo is, there should be at least two tie-downs holding it.

Figure 3.2 Using Tie-down Devices

The diagram shows a side view of a truck trailer. The trailer is divided into four 10-foot sections by vertical lines. Above each section, a horizontal line with a downward-pointing arrow indicates a tie-down point. The arrows are labeled '10''.

There are special requirements for securing heavy pieces of metal, pipe, and coiled steel, to name a few. Find out what they are if you are to carry such loads.

TIE-DOWN DEVICES

Larger Loads Require More Tie-downs. Pictured here is an example of a multi-tiered load with extra straps holding the bottom two layers. These straps are called belly or gut straps.

Figure 3.2a Using Tie-down Devices

The diagram shows a side view of a truck trailer with a multi-tiered load. The load is divided into four 10-foot sections. In addition to the vertical tie-downs, there are horizontal straps (belly or gut straps) across the bottom two layers of the load. The arrows are labeled '10''.

3.3.3 Header Boards

Front-end header boards (“headache racks”) protect you from your cargo in case of a crash or emergency stop. Make sure the front-end structure is in good condition. The front-end structure should block the forward movement of any cargo you carry.



3.3.4 Covering Cargo

There are two basic reasons for covering cargo:

1. To protect people from spilled cargo.
2. To protect the cargo from weather.

Cargo should have at least one tie-down for each ten feet of cargo. Make sure you have enough tie-downs to

Spill protection is a safety requirement in many states. Be familiar with the laws in the states in which you drive.

You should look at your cargo covers in the mirrors from time to time while driving. A flapping cover can tear loose, uncovering the cargo, and possibly block your view or someone else's.

3.3.5 Sealed and Containerized Loads

Containerized loads generally are used when freight is carried part way by rail or ship. Delivery by truck occurs at the beginning and/or end of the journey. Some containers have their own tie-down devices or locks that attach directly to a special frame. Others have to be loaded onto flatbed trailers and must be properly secured just like any other cargo.

You cannot inspect sealed loads, but you can and should check that you don't exceed gross weight and axle weight limits, because you are still responsible for an over loaded vehicle.

If you accept a sealed load, you should make sure the bill of lading states something to the effect of: "Shipper loaded & secured-sealed load". Police can break a seal on a load in an emergency, but you should not open a sealed load without the express permission of the shipper and your company.

3.4 CARGO NEEDING SPECIAL ATTENTION

3.4.1 Dry Bulk

Dry bulk tanks require special care because they have a high center of gravity, and the load can shift. Be extremely cautious (slow and careful) going around curves and making sharp turns.

3.4.2 Hanging Meat

Hanging meat (suspended beef, pork, lamb) in a refrigerated truck can be a very unstable load with a high center of gravity. Particular caution is needed on sharp curves such as off ramps and on ramps. Go slowly.

3.4.3 Livestock

Livestock can move around in a trailer, causing unsafe handling characteristics. With less than a full load, use false bulkheads to keep livestock bunched together. Even when bunched, special care is necessary because livestock can lean on curves. This shifts the center of gravity and makes rollover more likely.

3.4.4 Oversized Loads

Over-length, over-width, and/or overweight loads require special transit permits. Driving is usually limited to certain times. Special equipment may be necessary such as "wide load" signs, flashing lights, flags, etc. Such loads may require a police escort or pilot vehicles bearing warning signs and/or flashing lights. These special loads require special driving care.

Section 3- Test Your Knowledge

1. What four things related to cargo are drivers responsible for?
2. How often must you stop while on the road to check your cargo?
3. How is Gross Combination Weight Rating different from Gross Combination Weight?
4. Name two situations where legal maximum weights may not be safe.
5. What can happen if you don't have enough weight on the front axle?
6. What is the minimum number of tie-downs for any flatbed load?
7. What is the minimum number of tie-downs for a 20 foot load?
8. Name the two basic reasons for covering cargo on an open bed.
9. What must you check before transporting a sealed load?

These questions may be on your test. If you can't answer them all, re-read Chapter 3.

Chapter 4 : Transporting Passengers Safely

This Chapter Covers:



- Vehicle Inspection**
- Loading**
- On the Road**
- Post-trip Vehicle Inspection**
- Prohibited Practices**
- Use of Brake-Door Interlocks**

Bus drivers must have a commercial driver license if they drive a vehicle designed to seat 16 or more people, including the driver.

Bus drivers must have a passenger endorsement on their commercial driver's license. To get the endorsement, you must pass a knowledge test on Chapters 2, 3, and 4 of this manual. If your bus has air brakes, you must also pass a knowledge test on Chapter 5. You must also pass the skills tests in a passenger vehicle of the license class you wish to drive. If you operate a vehicle that requires a passenger endorsement (bus), you will only be authorized to operate the class of vehicle that you used in your passenger endorsement skills test (i.e., If you skills test in a Class C bus you cannot drive a Class B bus, but if test in a Class B bus, you can drive both Class B and C buses).

4.1 VEHICLE INSPECTION

You must complete a pre-trip safety inspection of your bus at the beginning of each day and/or shift. If the motor carrier is required to have their drivers prepare a Driver Vehicle Inspection Report by the Federal Motor Carrier Safety Regulations, you **must** review the last driver vehicle inspection report at the beginning of your workday to ensure any items listed on the last report that affect the safety of the bus have been repaired or were found to be unnecessary by the mechanic performing the repairs. The mechanic must certify the repairs were performed by placing his/her signature on the original inspection report. You **must** sign the same report certifying you have reviewed the report and accept the bus. You do not have to sign a report from the previous driver if no defects or deficiencies were noted.

4.1.1 Vehicle Systems

Make sure the following components are in good working order before driving:

- Service brakes, including air hose couplings (if your bus has a trailer or semitrailer).
- Parking brake.
- Steering mechanism.
- Lights and reflectors.
- Tires (front wheels must not have recapped or re-grooved tires).
- Horn.
- Windshield wipers.
- Rear-vision mirror or mirrors.
- Coupling devices (if present).
- Wheels and rims.
- Emergency equipment.

4.1.2 Access Doors and Panels

As you check the outside of the bus, close any open emergency exits. Also, close any open access panels (baggage, battery, restroom service, engine, etc.) before driving.

4.1.3 Bus Interior

People sometimes damage unattended buses. Always check the interior of the bus before driving to ensure rider safety. Aisles and stairwells should always be clear. The following parts of your bus must be in safe working condition:

- Each handhold and railing.

- Floor covering.
- Signaling devices, including the restroom emergency buzzer, if the bus has a restroom.
- Emergency exit handles.

The seats must be safe for riders. All seats must be securely fastened to the bus.

Never drive with an open emergency exit door or window. The “Emergency Exit” sign on an emergency door must be clearly visible. If there is a red emergency door light, it must work. Turn it on at night or any other time you use your outside lights.

4.1.4 Roof Hatches

You may lock some emergency roof hatches in a partly open position for fresh air. Do not leave them open as a regular practice. Keep in mind the bus’s higher clearance while driving with them open.

Make sure your bus has the fire extinguisher and emergency reflectors required by law. The bus must also have spare electrical fuses, unless equipped with circuit breakers.

4.1.5 Use Your Seatbelt!

The driver’s seat should have a seat belt in good working order. Always use it for safety, and because it’s the law.

4.2 LOADING AND TRIP START

Do not allow riders to leave carry-on baggage in a doorway or aisle. There should be nothing in the aisle that might trip other riders. Secure baggage and freight in ways that avoid damage and that:

- Allows the driver to move freely and easily.
- Allows riders to exit by any window or door in an emergency.
- Protects riders from injury if carry-on baggage falls or shifts.

4.2.1 Hazardous Materials

Watch for cargo or baggage containing hazardous materials. Most hazardous materials cannot be carried on a bus.

The Federal Hazardous Materials Table shows which materials are hazardous. They pose a risk to health, safety, and property during transportation. The rules require shippers to mark containers of hazardous material with the material’s name, identification number, and hazard label. There are nine different four inch, diamond-shaped hazard labels (**See Table 4.1**).

Class	Class Name	Example
1	Explosives	Ammunition, Dynamite, Fireworks
2	Gases	Propane, Oxygen, Helium
3	Flammable	Gasoline, Acetone
4	Flammable Solids	Matches, Fuses
5	Oxidizers	Ammonium Nitrate, Hydrogen Peroxide
6	Poisons	Pesticides, Arsenic
7	Radioactive	Uranium, Plutonium
8	Corrosives	Hydrochloric Acid, Battery Acid
9	Miscellaneous Hazardous Materials	Formaldehyde, Asbestos
None	ORM-D (Other Regulated Material, Domestic)	Hair Spray, Charcoal
None	Combustible Liquids	Fuel Oils, Lighter Fluid

Watch for the diamond-shaped labels and do not transport any hazardous material unless you are sure the rules allow it.

4.2.2 Forbidden Hazardous Materials

Buses may carry small-arms ammunition labeled ORM-D, emergency hospital supplies, and drugs. You can carry small amounts of some other hazardous materials if the shipper cannot send them any other way. Buses must never carry the following:

- Division 2.3 poison gas, liquid Class 6 poison, tear gas, irritating material.
- More than 100 pounds of solid Class 6 poisons.
- Explosives in the space occupied by people, except small arms ammunition.
- Labeled radioactive materials in the space occupied by people.
- More than 500 pounds total of allowed hazardous materials, and no more than 100 pounds of any one class.

Riders sometimes board a bus with an unlabeled hazardous material. Do not allow riders to carry on common hazards such as car batteries or gasoline.

4.2.3 Standee Line

No rider may stand forward of the rear of the driver's seat. Buses designed to allow standing must have a two inch line on the floor or some other means of showing riders where they cannot stand. This is called the standee line. All standing riders must stay behind it.

4.2.4 At Your Destination

When arriving at the destination or intermediate stops, announce in a clear voice:

- The location.
- Reason for Stopping.
- Next departure time.
- Bus number.

Remind riders to take carry-on baggage with them if they get off the bus. If the aisle is on a lower level than the seats, remind riders of the step-down. It is best to tell them before coming to a complete stop.

Charter bus drivers should not allow riders on the bus until departure time. This will help prevent theft or vandalism of the bus.

4.3 ON THE ROAD

4.3.1 Passenger Supervision

Many charter and intercity carriers have passenger comfort and safety rules. Mention rules about smoking, drinking, or use of radio and tape players at the start of the trip. Explaining the rules at the start will help to avoid trouble later on.

While driving, scan the interior of your bus as well as the road ahead, to the sides, and to the rear. You may have to remind riders about the rules, or to keep their arms and heads inside the bus.

4.3.2 Stops

Riders can stumble when getting on or off the bus, and when the bus starts or stops. Caution riders to watch their step when leaving the bus. Wait for them to sit down or brace themselves before starting. Starting and stopping should be as smooth as possible to avoid rider injury.

Occasionally, you may have a drunk or disruptive rider. You must ensure this rider's safety as well as that of others. Don't discharge such riders where it would be unsafe for them. It may be safer at the next scheduled stop or a well-lighted area where there are other people. Many carriers have guidelines for handling disruptive riders.

4.3.3 Common Accidents

The Most Common Bus Accidents: Bus accidents often happen at intersections. Use caution, even if a signal or stop sign controls other traffic. School and mass transit buses sometimes scrape off mirrors or hit passing vehicles when pulling out from a bus stop. Remember the clearance your bus needs, and watch for poles and tree limbs at stops. Know the size of the gap your bus needs to accelerate and merge with traffic and wait for the gap to open before leaving the stop. Never assume other drivers will brake to give you room when you signal or start to pull out.

4.3.4 Speed on Curves

Crashes on curves that kill people and destroy buses are the result of excessive speed, often when rain or snow has made the road slippery. Every banked curve has a safe "design speed." In good weather, the posted

speed is safe for cars, but it may be too high for many buses. If there is good traction, the bus may roll over; with poor traction, it might slide off the curve; therefore, you must reduce speed for curves! If your bus leans toward the outside on a banked curve, you are driving too fast.

4.3.5 Railroad-highway Crossings

Stop at Railroad Crossings:

- Stop your bus between 15 and 50 feet before railroad crossings.
- Listen and look in both directions for trains. You should open your forward door if it improves your ability to see or hear an approaching train.
- Before crossing after a train has passed, make sure there isn't another train coming in the other direction on other tracks.
- If your bus has a manual transmission, never change gears while crossing the tracks.
- You do not have to stop, but must slow down and carefully check for other vehicles in the following situations:
 - At streetcar crossings.
 - Where a policeman or flagman is directing traffic.
 - If a traffic signal is green.
 - At crossings marked as "exempt" or "abandoned."

4.3.6 Drawbridges

Stop at Drawbridges. Stop at drawbridges that do not have a signal light or traffic control attendant. Stop at least 50 feet before the draw of the bridge and look to make sure the draw is completely closed before crossing. You do not need to stop, but you must slow down and make sure it's safe, in the following situations:

- There is a traffic light showing green.

- The bridge has an attendant or traffic officer who controls traffic whenever the bridge opens.

4.4 POST-TRIP VEHICLE INSPECTION

Inspect your bus at the end of each shift. If the motor carrier is required to have their drivers prepare a Driver Inspection Report by the Federal Motor Carrier Safety Regulations, you **must** prepare a written inspection report at the completion of each day's work on each bus operated. You **must** identify the bus(s) you operated and list any defect or deficiency that would affect the safe operation of the bus that would cause the bus to suffer a mechanical breakdown. You must also prepare a written report if no equipment defect or deficiency is found. In all instances, you **must** sign the report.

The Driver's Inspection Report notifies the motor carrier of the condition of the bus and identifies any defects or deficiencies found that would make the bus unsafe or cause it to break down. Depending on the motor carrier's policy regarding the distribution of the inspection report, if possible, you should leave a copy of the inspection report in the bus for at least a day so it can be reviewed by the next driver.

4.5 PROHIBITED PRACTICES

Avoid fueling your bus with riders on board unless it is absolutely necessary. Never refuel in a closed building with riders on board.

Don't talk with riders (check your employer guidelines), or engage in any other distracting activity, while driving.

Do not tow or push a disabled bus with riders aboard the vehicle, unless getting off would be unsafe. Only tow or push the bus to the nearest safe spot to discharge passengers. Follow your employer's guidelines on towing or pushing disabled buses.

4.6 USE OF BRAKE-DOOR INTERLOCKS

Urban mass transit coaches may have a brake and accelerator interlock system. The interlock applies the service brakes and holds the throttle in idle position when the rear door is open. The interlock releases when you close the rear door. Do not use this safety feature in place of the parking brake.

Chapter 4- Test Your Knowledge

1. Name some things to check in the interior of a bus during a pre-trip inspection.
2. What are some hazardous materials you can transport by bus?
3. What are some hazardous materials you can't transport by bus?
4. What is a standee line?
5. Does it matter where you make a disruptive passenger get off the bus?
6. How far from a railroad crossing should you stop?
7. When must you stop before crossing a drawbridge?
8. Describe from memory the "prohibited practices" listed in the manual.
9. The rear door of a transit bus has to be open to put on the parking brake. True or False?

These questions may be on your test. If you can't answer them all, re-read Chapter 4.



Chapter 5 : Air Brakes

This Chapter Covers:



Air Brake System Parts
Dual Air Brake Systems
Inspecting Air Brakes
Using Air Brakes

This chapter tells you about air brakes. If you want to drive a truck or bus with air brakes, or pull a trailer with air brakes, you need to read this section. If you want to pull a trailer with air brakes, you also need to read Chapter 6, Combination Vehicles.

You only need to take a written and skills test on the air brake system if the vehicle you intend to drive has an air brake system and requires that you have a CDL to operate it. The air brake test is **not an endorsement, it is a restriction (L)** placed on a CDL when an applicant has not taken a written and/or skills test with a vehicle equipped with air brakes. To remove the restriction, you need to pass the written test and a modified skills test consisting of the pre-trip inspection and the road test. You do not have to take the basic control test. You can test in any class of vehicle to remove the restriction as long as it has an air brake system. Once you have passed a test in a vehicle with air brakes, the restriction is permanently lifted, and you can take any other endorsement test requiring a skills test (i.e., school bus or passenger) in a vehicle not equipped with air brakes without having the restriction being placed on your CDL.

Air brakes use compressed air to make the brakes work. Air brakes are a good and safe way of stopping large, heavy vehicles; however, the brakes must be well maintained and used properly.

Air brakes are really three different braking systems: service brake, parking brake, and emergency brake.

- The service brake system applies and releases the brakes when you use the brake pedal during normal driving.
- The parking brake system applies and releases the parking brakes when you use the parking brake control.

- The emergency brake system uses parts of the service and parking brake systems to stop the vehicle in a brake system failure.

The parts of these systems are discussed in greater detail below.

5.1 THE PARTS OF AN AIR BRAKE SYSTEM

There are many parts to an air brake system. You should know about the parts discussed here.

5.1.1 Air Compressor

The air compressor pumps air into the air storage tanks (reservoirs). The air compressor is connected to the engine through gears or a v-belt. The compressor may be air cooled or may be cooled by the engine cooling system. It may have its own oil supply or be lubricated by engine oil. If the compressor has its own oil supply, check the oil level before driving.

5.1.2 Air Compressor Governor

The governor controls when the air compressor will pump air into the air storage tanks. When air tank pressure rises to the “cut-out” level (around 125 pounds per square-inch or "psi"), the governor stops the compressor from pumping air. When the tank pressure falls to the “cut-in” pressure (around 100 psi), the governor allows the compressor to start pumping again.

5.1.3 Air Storage Tanks

Air storage tanks are used to hold compressed air. The number and size of air tanks varies among vehicles. The tanks will hold enough air to allow the brakes to be used several times, even if the compressor stops working.

5.1.4 Air Tank Drains

Compressed air usually has some water and some compressor oil in it, which is bad for the air brake system. For example, the water can freeze in cold weather and cause brake failure. The water and oil

tend to collect in the bottom of the air tank, so be sure that you drain the air tanks completely.

Each air tank is equipped with a drain valve in the bottom. There are two types:

1. Manually operated by turning a quarter turn or by pulling a cable. You must drain the tanks yourself at the end of each day of driving (**See Figure 5.1**).
2. Automatic - the water and oil are automatically expelled. These tanks may be equipped for manual draining as well.

Automatic air tanks are available with electric heating devices. These help prevent freezing of the automatic drain in cold weather.

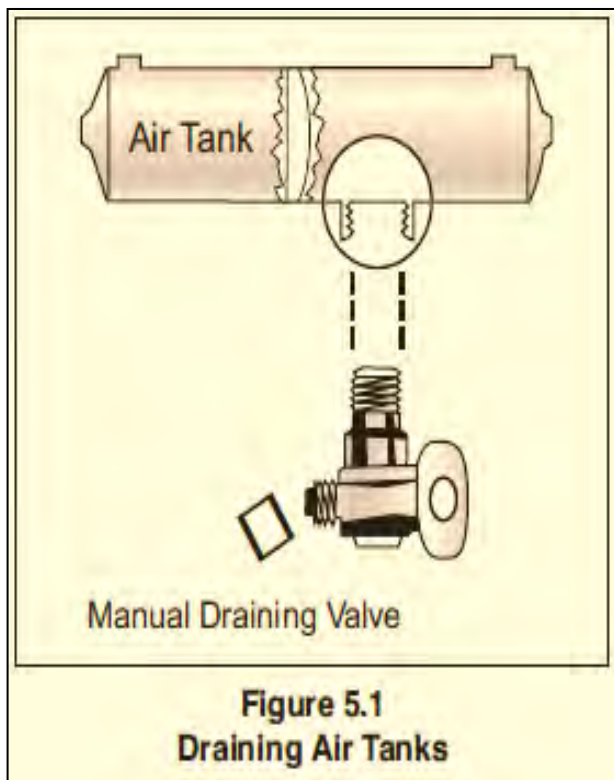

5.1.5 Alcohol Evaporator

Some air brake systems have an alcohol evaporator to put alcohol into the air system. This helps to reduce the risk of ice in air brake valves and other parts during cold

weather. Ice inside the system can make the brakes stop working.

Check the alcohol container and fill up as necessary, every day during cold weather. Daily air tank drainage is still needed to get rid of water and oil unless the system has automatic drain valves.

5.1.6 Safety Valve

A safety relief valve is installed in the first tank the air compressor pumps air to. The safety valve protects the tank and the rest of the system from too much pressure. The valve is usually set to open at 150 psi. If the safety valve releases air, something is wrong. Have the fault fixed by a mechanic.

5.1.7 The Brake Pedal

You put on the brakes by pushing down the brake pedal (also called the foot valve or treadle valve). Pushing the pedal down harder applies more air pressure. Letting up on the brake pedal reduces the air pressure and releases the brakes. Releasing the brakes lets some compressed air go out of the system, so the air pressure in the tanks is reduced. It must be made up by the air compressor. Pressing and releasing the pedal unnecessarily can let air out faster than the compressor can replace it. If the pressure gets too low, the brakes won't work.

5.1.8 Foundation Brakes

Foundation brakes are used at each wheel. The most common type is the S-cam drum brake. The parts of the brake are discussed below.

Brake Drums, Shoes, and Linings: Brake drums are located on each end of the vehicle's axles. The wheels are bolted to the drums. The braking mechanism is inside the drum. To stop, the brake shoes and linings are pushed against the inside of the drum. This causes friction, which slows the vehicle and creates heat. The heat a drum can take without damage depends on how hard and how long the brakes are used. Too much heat can make the brakes stop working (also called fade).

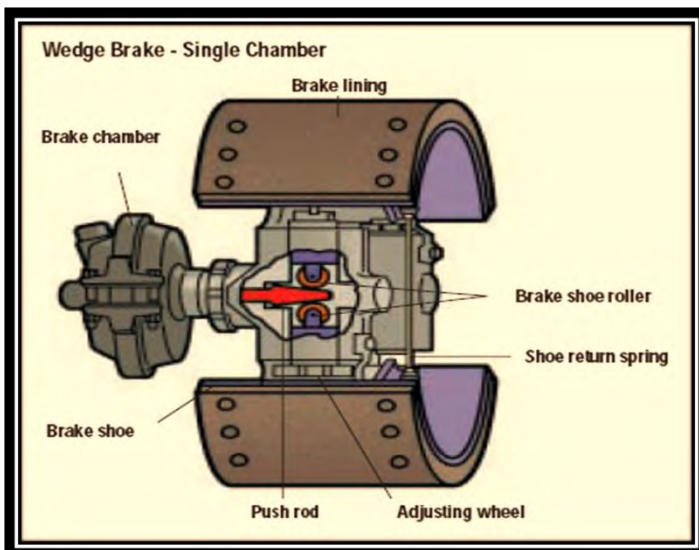
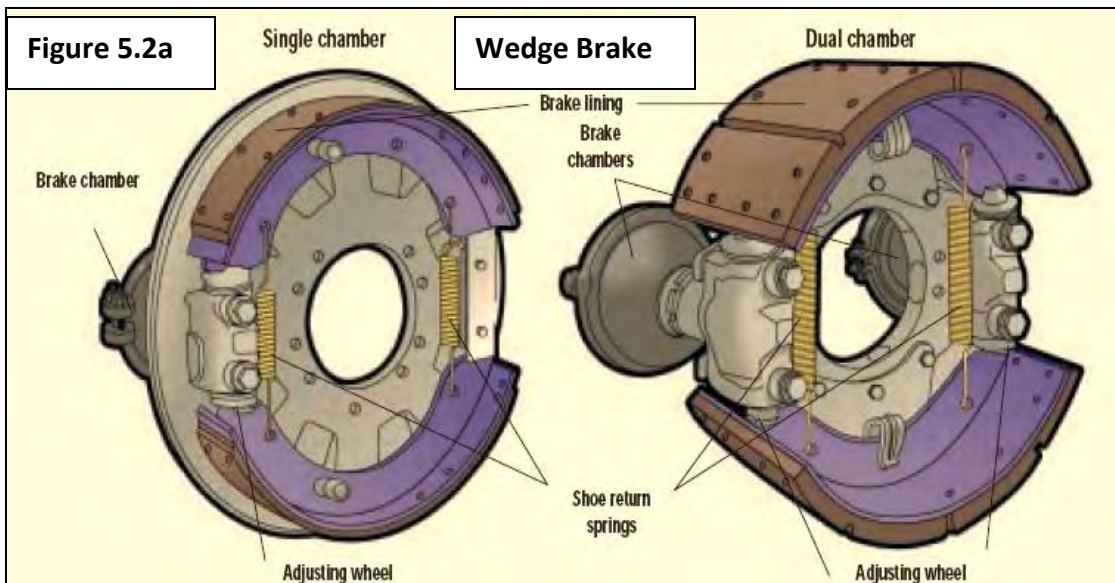
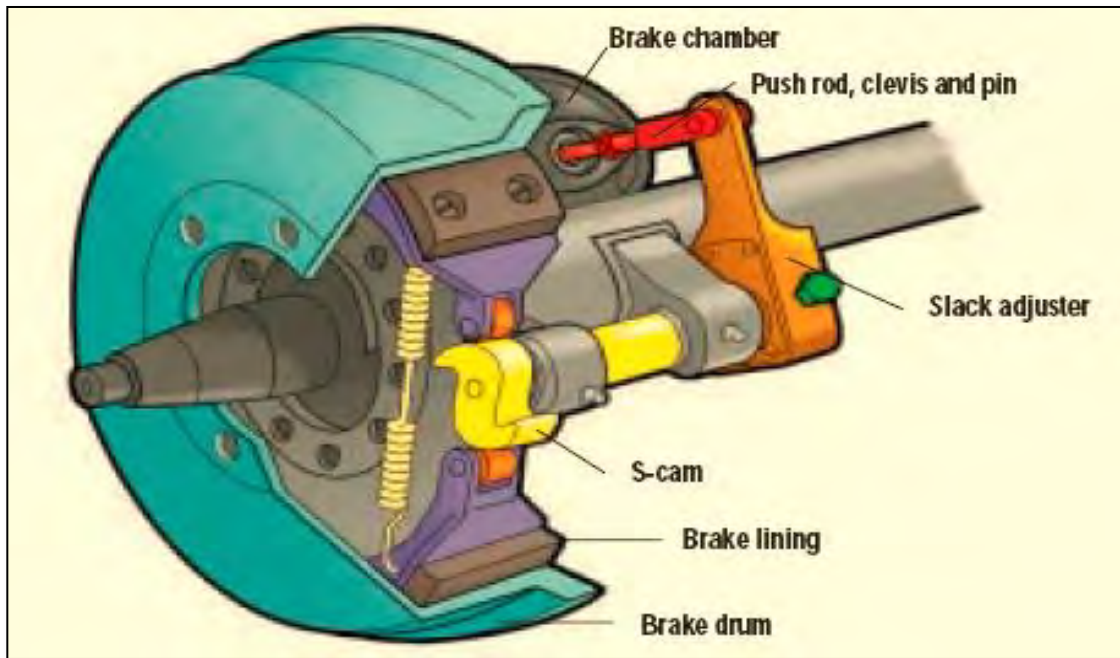

S-cam Brakes: When you push the brake pedal, air is let into each brake chamber. Air pressure pushes the rod out, moving the slack adjuster, thus twisting the brake camshaft. This turns the S-cam (so called because it is shaped like the letter "S"). The S-cam forces the brake shoes away from one another and presses them against the inside of the brake drum. When you release the brake pedal, the S-cam rotates back and a spring pulls the brake shoes away from the drum, letting the wheels roll freely again (**See Figure 5.2**).

Wedge Brakes: In this type of brake, the brake chamber push rod pushes a wedge directly between the ends of two brake shoes. This shoves them apart and against the inside of the brake drum. Wedge brakes may have a single brake chamber, or two-brake

chambers pushing wedges in at both ends of the brake shoes. Wedge type brakes may be self-adjusting or may require manual adjustment (See Figure 5.2a).

Air Disc (Disk) Brakes: In air-operated disc brakes, air pressure acts on a brake chamber and slack adjuster like S-cam brakes, but instead of the S-cam, a “power screw” is used. When the brakes are applied, the pressure of the brake chamber on the slack adjuster turns the power screw causing the caliper to clamp two brake pads against a rotor (like a C-clamp). Air discs, compared to drum-type brakes, have superior ability to resist fade. Wedge brakes and disc brakes are less common than S-cam brakes See Figure 5.2b).



Figure 5.2b

5.1.9 Supply Pressure Gauges

All vehicles with air brakes have a pressure gauge connected to the air tank. If the vehicle has a dual air brake system, there will be a gauge for each half of the system, or a single gauge with two needles. Dual systems will be discussed later. These gauges tell you how much pressure is in the air tanks.



5.1.10 Application Pressure Gauge

This gauge shows how much air pressure you are applying to the brakes (This gauge is not on all vehicles). **Increasing application pressure to hold the same speed means the brakes are fading.** You should slow down and use a lower gear. The need for increased pressure



can also be caused by brakes out of adjustment, air leaks, or mechanical problems.

5.1.11 Low Air Pressure Warning

A low air pressure warning signal is required on vehicles with air brakes. A warning signal you can see must come on before the air pressure in the tanks falls below 60 psi (or one half the compressor governor cutout air pressure on older vehicles). The warning is usually a red light. A buzzer may also come on.



Another type of warning found on some old trucks and busses is the “wig wag.” This device drops a mechanical arm into your view when the pressure in the system drops below 60 psi. An automatic wig wag will rise out of your view when the pressure in the system goes above 60 psi. The manual reset type must be

placed in the “out of view” position manually, and it will not stay in place until the pressure in the system is above 60 psi.

On large buses it is common for the low pressure warning devices to signal at 80-85 psi.

5.1.12 Stop Light Switch

Drivers behind you must be warned when you put your brakes on. The air brake system does this with an electric switch that works by air pressure. The switch turns on the brake lights when you put on the air brakes.

5.1.13 Front Brake Limiting Valve

Some older vehicles (made before 1975) have a front brake limiting valve and a control in the cab. The control is usually marked “normal” and “slippery.” When you put the control in the “slippery” position, the limiting valve cuts the “normal” air pressure to the front brakes by half. Limiting valves were used to reduce the chance of the front wheels skidding on slippery surfaces; however, they actually reduce the stopping power of the vehicle. Front wheel braking is good under all conditions. Tests have shown front wheel skids from braking are not likely even on ice. Make sure the control is in the “normal” position to have normal stopping power.

Many vehicles have automatic front wheel limiting valves. They reduce the air to the front brakes except when the brakes are put on very hard (60 psi or more application pressure). These valves cannot be controlled by the driver.

5.1.14 Spring Brakes



All trucks, truck tractors, and buses must be equipped with emergency brakes and parking brakes. They must be held on by mechanical force, because air pressure can eventually leak away. Spring brakes are usually used to meet

these needs. **When driving, powerful springs are held back by air pressure. If the air pressure is removed, the springs put on the brakes.** A parking brake control in the cab allows the driver to let the air out of the spring brakes which applies the brakes (the linings will be forced against the drums). A leak in the air brake system, which causes all the air to be lost, will also cause the springs to put on the brakes.

Tractor and straight truck spring brakes will come fully on when air pressure drops to a range of 20 to 45 psi

(typically 20 to 30 psi). Do not wait for the brakes to come on automatically. When the low air pressure warning light and buzzer first come on, bring the vehicle to a safe stop right away, while you can still control the brakes.

The braking power of spring brakes depends on the brakes being in adjustment. If the brakes are not adjusted properly, neither the regular brakes nor the emergency/parking brakes will work right.

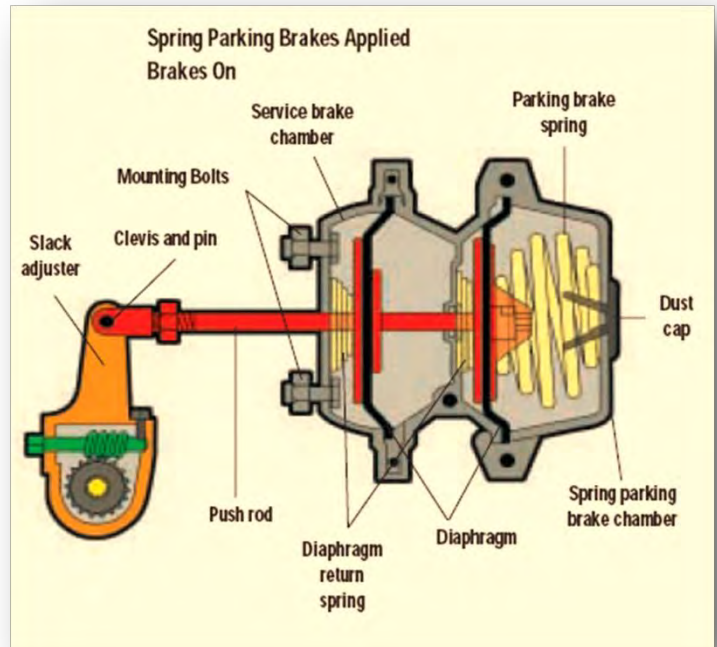

5.1.15 Parking Brake Controls



In newer vehicles with air brakes, you put on the parking brakes using a diamond-shaped, yellow, push-pull control knob.

You pull the knob out to put the parking brakes (spring brakes) on, and push it in to release them. On older vehicles, the parking brakes may be controlled by a lever. Use the parking brakes whenever you park.

Caution! Never push the brake pedal down when the spring brakes are on. If you do, the brakes could be damaged by the combined forces of the springs and the air pressure. Brake compounding can occur in a spring brake parking system due to the mechanical and

pneumatic nature of the chamber. It will occur in unprotected systems when parking AND service brake applications are made at the same time. An example of this situation occurs when a vehicle is parked on a steep incline; the driver holds the service brakes applied (preventing the vehicle from rolling backward), then actuates the park control which "sets" or applies the spring brakes. For a brief time, the air applied service brakes and the mechanical spring brakes both exert a braking force on the slack adjusters and foundation brakes. The forces of the spring and air applications are additive and can cause damage to the foundation brake components (cam shaft splines, shoes, drum, etc.) and/or slack adjuster.

An anti-compounding system is especially important in protecting the adjusting mechanism of automatic slack adjusters from damage caused by over torque that occurs during a compounded application of the brakes. The anti-compounding system prevents the simultaneous application of both the air and spring brakes by directing application air to the spring brakes when both are applied at once. The double check valve allows service application air to apply the service brakes AND move into the spring cavity if they are also applied (no air pressure and springs are also applying brakes). The anti-compounding function of the double check valve is built into several air brake devices, but not all systems are set up that way, and those that are may not always work. It is much better to develop the habit of not pushing the brake pedal down when the spring brakes are on.

Modulating Control Valves:

In some vehicles a control handle on the steering column or dash board may be used to apply the spring brakes gradually. This is called a modulating valve (also known as a Trolley Valve or Johnson Bar). It is spring-loaded so you have a feel for the braking



action. The more you move the control lever, the harder the spring brakes come on. They work this way so you can control the spring brakes if the service brakes fail. Do not use the modulating control valve to park a vehicle. Use the parking brake(s).

Dual Parking Control Valves: When main air pressure is lost, the spring brakes come on. Some vehicles, such as buses, have a separate air tank which can be used to release the spring brakes. This is so you can move the vehicle in an emergency. One of the valves is a push-pull type and is used to put on the spring brakes for parking. The other valve is spring loaded in the "out" position. When you push the control in, air from the separate air tank releases the spring brakes so you can move the vehicle.

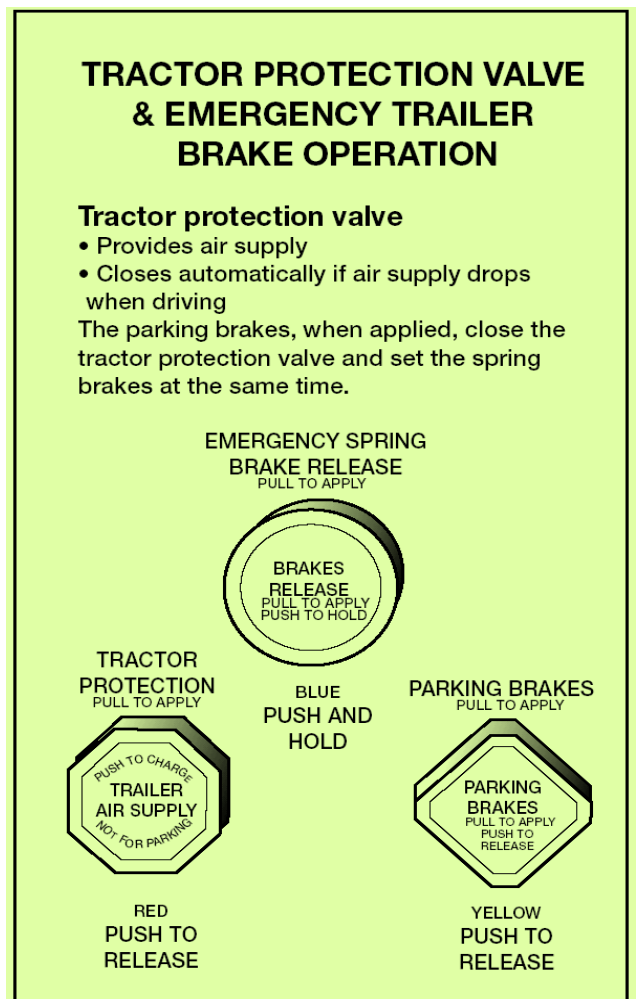

Figure 5.3

When you release the button, the spring brakes come on again. There is only enough air in the separate tank to do this a few times. Therefore, plan carefully when moving the bus, otherwise, you may be stopped in a dangerous location when the separate air supply runs out (See Figure 5.3).

5.1.16 Antilock Braking Systems (ABS)

Truck tractors with air brakes built on or after March 1, 1997, and other air brakes vehicles, (trucks, buses, trailers, and converter dollies) built on or after March 1,

1998, are required to be equipped with antilock brakes. Many commercial vehicles built before these dates have been voluntarily equipped with ABS. Check the certification label for the date of manufacture to determine if your vehicle is equipped with ABS. ABS is a computerized system that keeps your wheels from locking up during hard brake applications.

Vehicles with ABS have yellow malfunction lamps to tell you if something isn't working. Tractors, trucks, and buses will have yellow ABS malfunction lamps on the instrument panel. Trailers will have yellow ABS malfunction lamps on the left side, either on the front or rear corner. Dollies manufactured on or after March 1, 1998 are required to have a lamp on the left side.

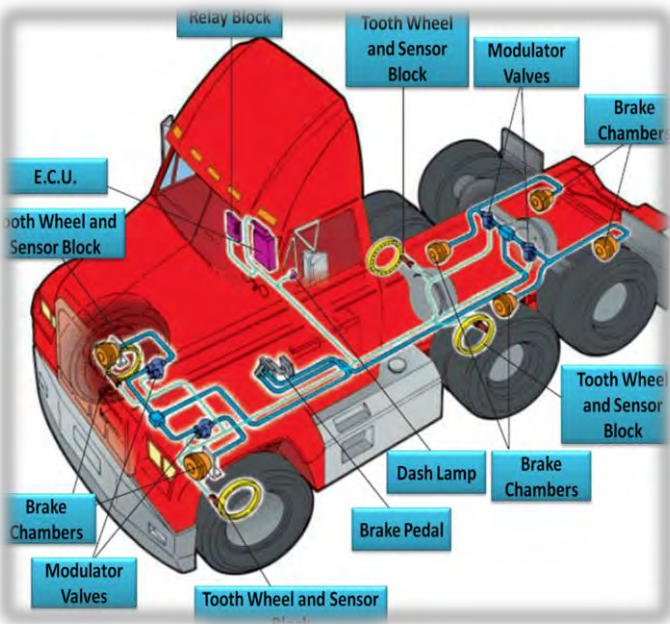

On newer vehicles, the malfunction lamp comes on at start-up for a bulb check, and then goes out quickly. On older systems, the lamp could stay on until you are driving over five mph.

If the lamp stays on after the bulb check, or goes on once you are under way, you may have lost ABS control at one or more wheels.

In the case of towed units manufactured before it was required by the Department of Transportation, it may be difficult to tell if the unit is equipped with ABS. Look under the vehicle for the electronic control unit (ECU) and wheel speed sensor wires coming from the back of the brakes.

ABS is an addition to your normal brakes. It does not decrease or increase your normal braking capability. ABS only activates when wheels are about to lock up. ABS does not necessarily shorten your stopping distance, but it does help you keep the vehicle under control during hard braking.

Subsection 5.1

Test Your Knowledge

1. Why must air tanks be drained?
2. What is a supply pressure gauge used for?
3. All vehicles with air brakes must have a low air pressure warning signal. True or False?
4. What are spring brakes?
5. Front wheel brakes are good under all conditions. True or False?
6. How do you know if your vehicle is equipped with antilock brakes?

These questions may be on your test. If you can't answer them all, re-read subsection 5.1.

5.2 DUAL AIR BRAKE

Most heavy-duty vehicles use dual air brake systems for safety. A dual air brake system has two separate air brake systems, which use a single set of brake controls. Each system has its own air tanks, hoses, lines, etc. One system typically operates the regular brakes on the rear axle or axles. The other system operates the regular brakes on the front axle, and possibly one rear axle. Both systems supply air to the trailer (if there is one). The first system is called the "primary" system. The other is called the "secondary" system (See Figure 5.4 and Air Brake Appendix 1 at end of this chapter).

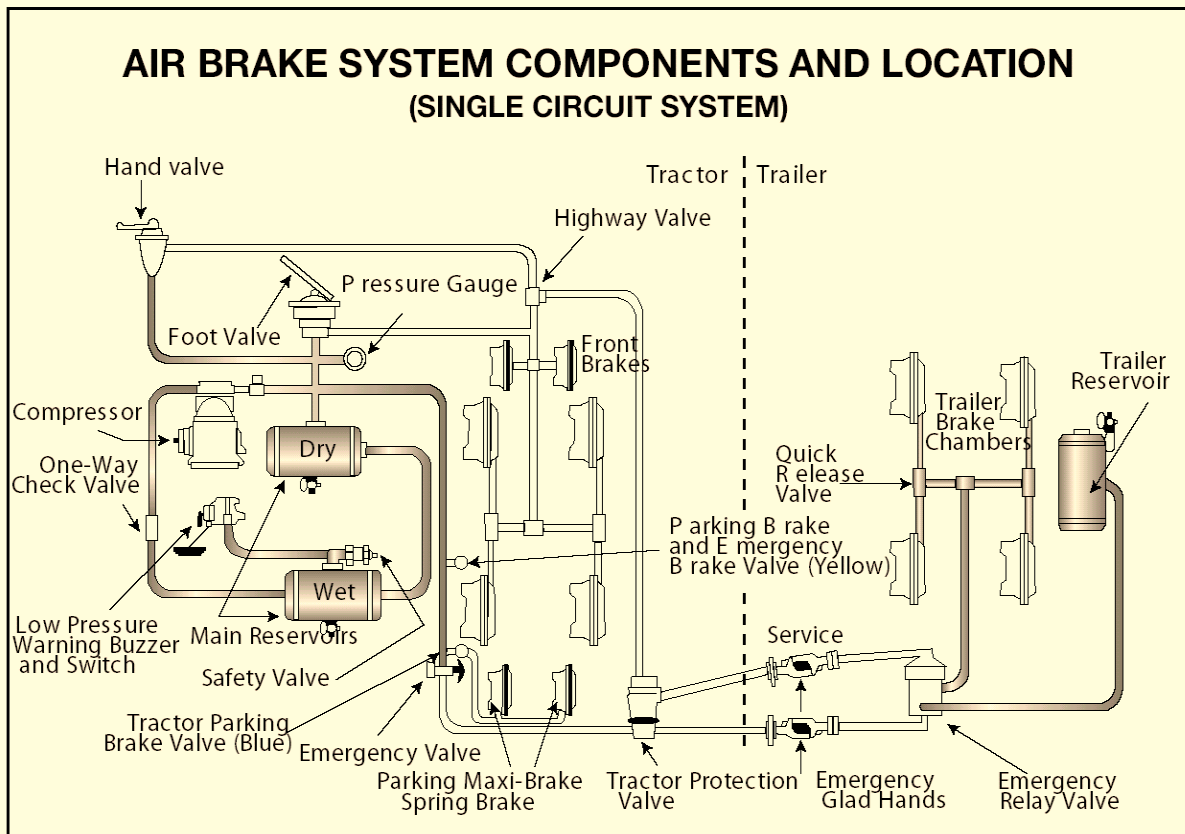

Figure 5.4 Air Brake System Components and Location

Before driving a vehicle with a dual air system, allow time for the air compressor to build up a minimum of 100 psi pressure in both the primary and secondary systems. Watch the primary and secondary air pressure gauges (or needles, if the system has two needles in one gauge). Pay attention to the low air pressure warning light and buzzer. The warning light and buzzer should shut off when air pressure in both systems rises to a value set by the manufacturer. This value must be greater than 60 psi.

The warning light and buzzer should come on before the air pressure drops below 60 psi in either system. If this happens while driving, you should stop right away and safely park the vehicle. If one air system is very low on pressure, either the front or the rear brakes will not be operating fully. This means it will take you longer to stop. Bring the vehicle to a safe stop, and have the air brakes system fixed.

5.3 INSPECTING AIR BRAKE SYSTEMS

You should use the basic seven-step inspection procedure described in Chapter 2 to inspect your vehicle. There are more things to inspect on a vehicle with air brakes than one without them. These things

are discussed below, in the order they fit into the seven-step method.

5.3.1 During Step 2: Engine Compartment Checks

Check Air Compressor Drive Belt (if compressor is belt-driven). If the air compressor is belt-driven, check the condition and tightness of the belt. It should be in good condition.

5.3.2 During Step 5: Walk-around Inspection

Check Slack Adjusters on S-cam Brakes: Park on level ground and chock the wheels to prevent the vehicle from moving. Turn off the parking brakes so you can move the slack adjusters. Use gloves and pull hard on each slack adjuster that you can reach. If a slack adjuster moves more than about one inch where the push rod attaches to it, it probably needs adjustment. Adjust it or have it adjusted. Vehicles with too much brake slack can be very hard to stop. Out-of-adjustment brakes are the most common problem found in roadside inspections. Be safe and check the slack adjusters.

All vehicles built since 1991 have automatic slack adjusters. **Even though automatic slack adjusters adjust themselves during full brake applications, they must be checked.**

Automatic adjusters should not have to be manually adjusted except when performing maintenance on the brakes and during installation of the slack adjusters. In a vehicle equipped with automatic adjusters, when the pushrod stroke exceeds the legal brake adjustment limit, it is an indication that a mechanical problem exists in the adjuster itself, a problem with the related foundation brake components, or that the adjuster was improperly installed.

The manual adjustment of an automatic adjuster to bring a brake pushrod stroke within legal limits is generally masking a mechanical problem and is not fixing it. It may be dangerous because it can give the vehicle operator a false sense of security about the effectiveness of the braking system. Continued routine adjustment of most automatic adjusters will likely result in premature wear of the adjuster itself. It is recommended that when brakes equipped with automatic adjusters are found to be out of adjustment, the driver take the vehicle to a repair facility as soon as possible to have the problem corrected.

The manual adjustment of an automatic adjuster should only be used as a temporary measure to correct the adjustment in an emergency situation as it is likely the brake will soon be back out of adjustment since this procedure usually does not fix the underlying adjustment problem.

Note: Automatic slack adjusters are made by different manufacturers and do not all operate the same; therefore, the specific manufacturer's Service Manual should be consulted prior to troubleshooting a brake adjustment problem.

Mechanical Release (Caging): Some spring parking brakes can be released mechanically by "winding them off" or "caging" them (See Figure 5.4a). Caging means the brakes are being released. During your inspection, be sure the brakes have not been "caged" by another driver.

Caging the brakes is achieved with a bolt that runs through the center of the chamber body, which is turned to compress the spring. It may be necessary to first remove a lock plate and stud to gain access to the

head of the bolt. Other types have a dust cap that must first be removed and a bolt inserted. In some cases, a special wrench is required. Instructions on how to "cage" is usually on the body of the parking brake chamber. If all air is lost and the vehicle has to be towed, the parking brakes can be released by caging them. Always block the wheels when caging the parking brake spring.

WARNING: Spring parking brake chambers should never be disassembled without first compressing the spring with a caging bolt. These springs are under extreme pressure and could cause serious personal injury if disassembly is attempted by anyone not experienced in servicing these units. Disassembly of a spring brake chamber should only be performed by a qualified mechanic or technician.

Figure 5.4a

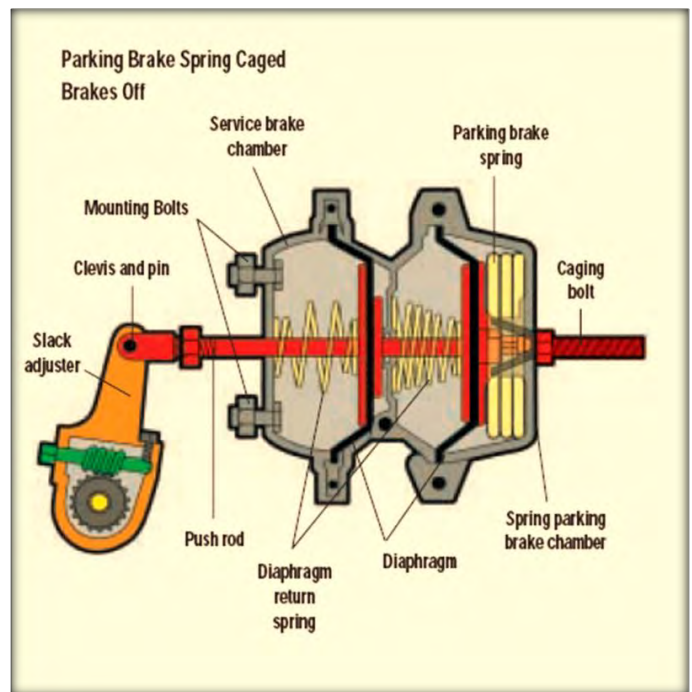

Drums (or Rotors), Linings, (or Pads) and Hoses: Brake drums (or rotors) must not have cracks longer than one half the width of the friction area. Brake linings, or pads (friction material) must not be loose or soaked with oil or grease. They must not be dangerously thin (approximately 1/4 inch minimum linings or pads present). Mechanical parts must be in place, not broken or missing. Check the air hoses connected to the brake chambers to make sure they aren't cut or worn due to rubbing.

5.3.3 During Step 7: Final Air Brake Check

Do the following checks instead of the hydraulic brake check shown in Chapter 2, Step 7: Check Brake System.

Check Rate of Air Pressure Buildup: When the engine is at normal operating speed, the pressure should build from 85 to 100 psi within 45 seconds in dual air systems (if the vehicle has larger than minimum air tanks, the buildup time can be longer and still be safe. Check the manufacturer's specifications. In single air systems (pre-1975), typical requirements are pressure build up from 50 to 90 psi within 3 minutes with the engine at an idle speed of 600-900 rpm.

If air pressure does not build up fast enough, your pressure may drop too low during driving requiring an emergency stop. Don't drive until you get the problem fixed.

Check Air Compressor Governor Cut-in and Cut-out Pressures: Pumping by the air compressor should start at about 100 psi and stop at about 125 psi (check manufacturer's specifications). Run the engine at a fast idle. The air governor should cut-out the air compressor at about the manufacturer's specified pressure. The air pressure shown by your gauge(s) will stop rising. With the engine idling, step on and off the brake to reduce the air tank pressure. The compressor should cut-in at about the manufacturer's specified cut-in pressure. The pressure should begin to rise.

If the air governor does not work as described above, it may need to be fixed. A governor that does not work properly may not keep enough air pressure for safe driving.

Test Air Leakage Rate: With a fully-charged air system (typically 125 psi), turn off the engine, release the parking brake, and time the air pressure drop. The loss rate should be less than two psi in one minute for single vehicles and less than three psi in one minute for combination vehicles. Then apply 90 psi or more with the brake pedal. After the initial pressure drop, if the air pressure falls more than three psi in one minute for single vehicles (more than four psi for combination vehicles), the air loss rate is too much. Check for air leaks and fix before driving the vehicle. Otherwise, you could lose your brakes while driving.

Test Low Pressure Warning Signal: Shut the engine off when you have enough air pressure so that the low pressure warning signal is not on. Turn the electrical power on and step on and off the brake pedal to reduce air tank pressure. The low air pressure warning signal must come on before the pressure drops to less than 60 psi in the air tank (or tank with the lowest air pressure, in dual air systems) (See Figure 5.5).

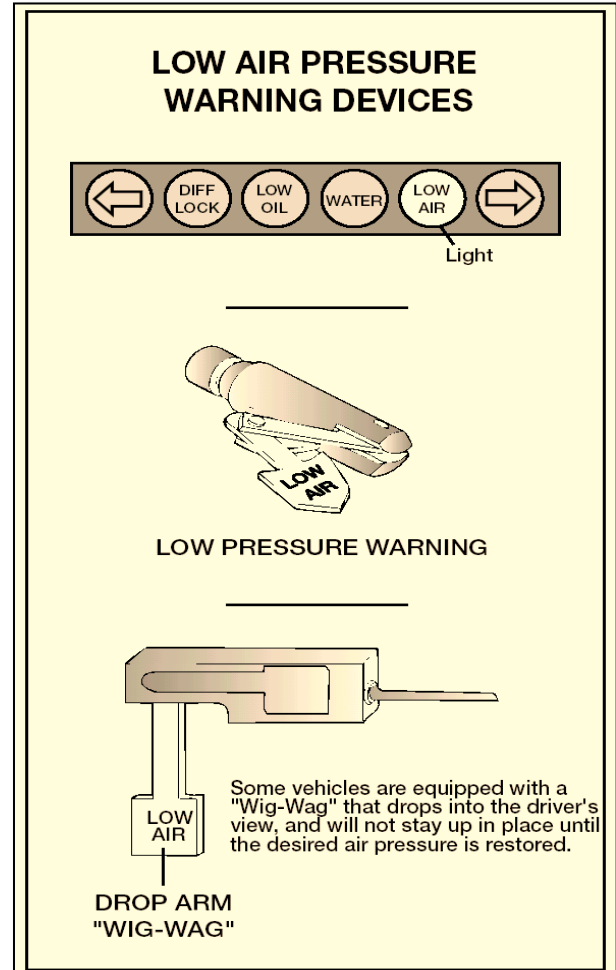

Figure 5.5

If the warning signal doesn't work, you could lose air pressure and you would not know it. This could cause sudden emergency braking in a single-circuit air system. In dual systems, the stopping distance will be increased. Only limited braking can be done before the spring brakes come on.

Check Spring Brakes Come On Automatically: Continue to fan off the air pressure by stepping on and off the brake pedal to reduce tank pressure. The tractor protection valve and parking brake valve should close (pop out) on a tractor-trailer combination vehicle, and the parking brake valve should close (pop out) on other combination and single vehicle types when the air

pressure falls to the manufacturer's specification (20 – 45 psi). This will cause the spring brakes to come on.



Drive forward slowly and pull gently against the brake.

Test Parking Brake:

Test the parking brake on single vehicles using the following method:



Apply the parking brake.



Place the vehicle in low gear.



Drive forward slowly and pull gently against the brake.



If the brake doesn't stop the vehicle from moving forward, it is faulty and must be fixed before you travel.

Test the parking brakes on combination vehicles using the following method:



Apply the Parking brake (pull out) and release (push in) the Tractor Protection Valve (also known as Trailer Air Supply)



Place the vehicle in low gear.



Drive forward slowly and pull gently against the brake.



If the brake doesn't stop the vehicle from moving forward, it is faulty and must be fixed before you travel.



Apply the Tractor Protection Valve (pull out) and release (push in) the parking brake.



Place the vehicle in low gear.

If the brake doesn't stop the vehicle from moving forward, it is faulty and must be fixed before you travel.

Test Service Brakes: Wait for normal air pressure, release the parking brake, move the vehicle forward slowly (about five mph), and apply the brakes firmly using the brake pedal. Note any vehicle "pulling" to one side, unusual feel, or delayed stopping action. This test may show you problems, which you otherwise wouldn't know about until you needed the brakes on the road.

Subsections 5.2 and 5.3

Test Your Knowledge

1. What is a dual air brake system?
2. What are the slack adjusters?
3. How can you check slack adjusters?
4. How can you test the low pressure warning signal?
5. How can you check that the spring brakes come on automatically?
6. What are the maximum leakage rates?

These questions may be on your test. If you can't answer them all, re-read subsections 5.2 and 5.3.

5.4 USING AIR BRAKES

5.4.1 Normal Stops

Push the brake pedal down. Control the pressure so the vehicle comes to a smooth, safe stop. If you have a manual transmission, don't push the clutch in until the engine rpm is down close to idle. When stopped, select a starting gear.

5.4.2 Braking with Antilock Brakes

When you brake hard on slippery surfaces in a vehicle without ABS, your wheels may lock up. When your steering wheels lock up, you lose steering control. When your other wheels lock up, you may skid, jackknife, or even spin the vehicle.

ABS helps you avoid wheel lock up. The computer senses impending lockup, reduces the braking pressure to a safe level, and you maintain control.

You may or may not be able to stop faster with ABS, but you should be able to steer around an obstacle while braking, and avoid skids caused by over braking.

Having ABS on only the tractor, only the trailer, or even on only one axle, still gives you more control over the vehicle during braking. Brake normally.

When only the tractor has ABS, you should be able to maintain steering control, and there is less chance of jackknifing, but keep your eye on the trailer and let up on the brakes (if you can safely do so) if it begins to swing out.

When only the trailer has ABS, the trailer is less likely to swing out, but if you lose steering control or start a tractor jackknife, let up on the brakes (if you can safely do so) until you gain control.

When you drive a tractor-trailer combination with ABS, you should brake as you always have. In other words:

- Use only the braking force necessary to stop safely and stay in control.
- Brake the same way, regardless of whether you have ABS on the tractor, the trailer, or both.
- As you slow down, monitor your tractor and trailer and back off the brakes (if it is safe to do so) to stay in control.

There is only one exception to this procedure. During an emergency stop (with working ABS on both tractor and trailer) when hard braking is required, apply continuous pressure on the brake pedal. **Do Not Pump the Brake Pedal** as this will defeat the system's design and reduce the effectiveness of the ABS and cause the vehicle to increase its stopping distance. The ABS will activate immediately, allowing you to retain full steering control during hard braking and on slippery surfaces; however, ABS does not decrease stopping distances.

During hard braking with ABS, the system actually pumps the brakes for you at a higher rate than you could do yourself. This pumping action causes a noise from the ABS pump motor, and you may feel a

noticeable pulse through the brake pedal. Do not be concerned by the noise and pulsation, because this is normal. Knowing you will hear the pump motor and feel the pulse will help you resist the natural instinct to remove your foot from the pedal.

Without ABS, you still have normal brake functions. Drive and brake as you always have. Remember, if your ABS malfunctions, you still have regular brakes. Drive normally, but get the system serviced soon.

5.4.3 Emergency Stops

If somebody suddenly pulls out in front of you, your natural response is to hit the brakes. This is a good response if there's enough distance to stop, and you use the brakes correctly.

You should brake in a way that will keep your vehicle in a straight line and allow you to turn if it becomes necessary. Unless you have ABS on your vehicle, you can use the "controlled braking" method or the "stab braking" method.

Controlled Braking: With this method, you apply the brakes as hard as you can without locking the wheels. Keep steering wheel movements very small while doing this. If you need to make a larger steering adjustment or if the wheels lock, release the brakes. Re-apply the brakes as soon as you can.

Stab Braking

- Apply your brakes all the way.
- Release brakes when wheels lock up.
- As soon as the wheels start rolling, apply the brakes fully again (it can take up to one second for the wheels to start rolling after you release the brakes. If you re-apply the brakes before the wheels start rolling, the vehicle won't straighten out).

5.4.4 Stopping Distance

Stopping distance was described in Chapter 2 under "Speed and Stopping Distance." With air brakes there is an added delay - "Brake Lag". This is the time required for the brakes to work after the brake pedal is pushed. With hydraulic brakes (used on cars and light/medium trucks), the brakes work instantly. However, with air

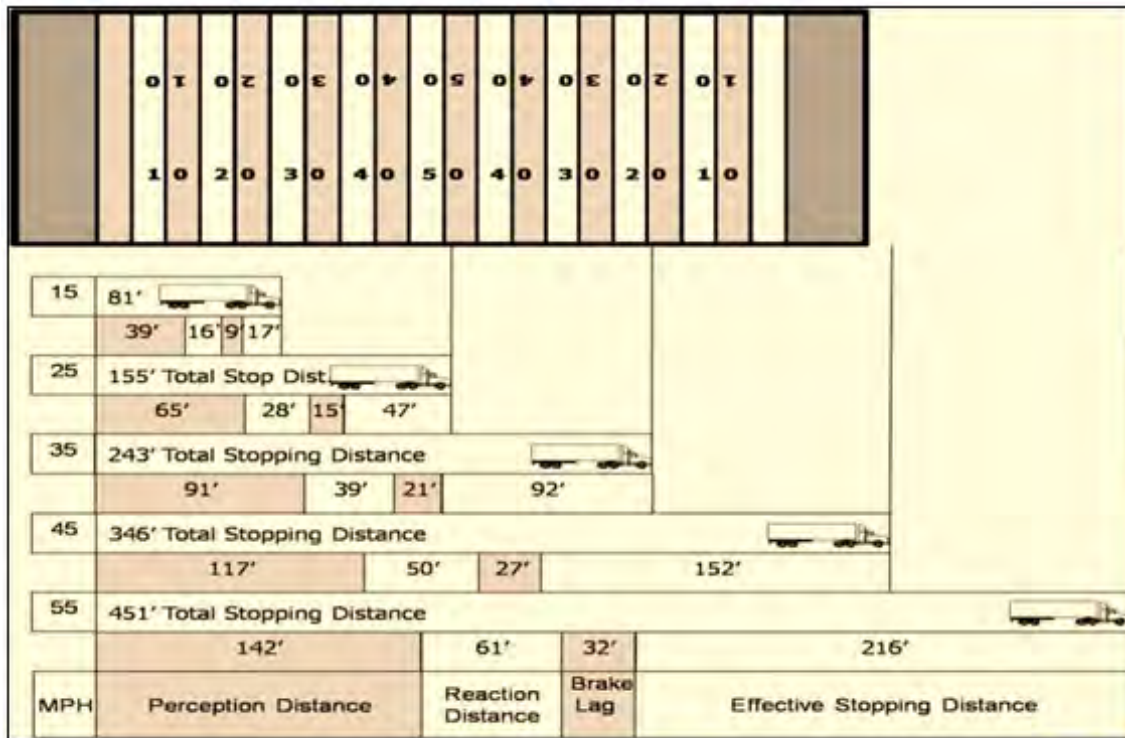

The air brake lag distance at 55 mph on dry pavement adds about 32 feet. So at 55 mph for an average driver under good traction and brake conditions, the total stopping distance is over 450 feet.

brakes, it takes a little time (one half second or more) for the air to flow through the lines to the brakes. Thus, the total stopping distance for vehicles with air brake systems is made up of four different factors. Perception Distance + Reaction Distance + Brake Lag Distance + Effective Stopping Distance = Total Stopping Distance (See Figure 5.6)

5.4.5 Brake Fading or Failure

Brakes are designed so brake shoes or pads rub against the brake drum or disks to slow the vehicle. Braking creates heat, but brakes are designed to take a lot of heat; however, brakes can fade or fail from excessive heat caused by using them too much and not relying on the engine braking effect.

Excessive use of the service brakes results in overheating and leads to brake fade. Brake fade results from excessive heat causing chemical changes in the brake lining, which reduce friction, and also causing expansion of the brake drums. As the overheated drums expand, the brake shoes and linings have to move farther to contact the drums, and the force of this contact is reduced. Continued overuse may increase brake fade until the vehicle cannot be slowed down or stopped.

Brake fade is also affected by adjustment. To safely control a vehicle, every brake must do its share of the work. Brakes out of adjustment will stop doing their share before those that are in adjustment. The other brakes can then overheat and fade, and there will not be enough braking available to control the vehicle(s). Brakes can get out of adjustment quickly, especially when they are hot; therefore, check brake adjustment often.

5.4.6 Proper Braking Technique

Remember: The use of brakes on a long and/or steep downgrade is only a supplement to the braking effect of the engine. Once the vehicle is in the proper low gear, the following is the proper braking technique:

1. Apply the brakes just hard enough to feel a definite slowdown.
2. When your speed has been reduced to approximately five mph below your "safe" speed, release the brakes (this application should last for about three seconds).
3. When your speed has increased to your "safe" speed, repeat steps 1 and 2.

For example, if your “safe” speed is 40 mph, you would not apply the brakes until your speed reaches 40 mph. You now apply the brakes hard enough to gradually reduce your speed to 35 mph and then release the brakes. Repeat this as often as necessary until you have reached the end of the downgrade.

5.4.7 Low Air Pressure

If the low air pressure warning comes on, stop and safely park your vehicle as soon as possible. There might be an air leak in the system. Controlled braking is possible only while enough air remains in the air tanks. The spring brakes will come on when the air pressure drops into the range of 20 to 45 psi. A heavily loaded vehicle will take a long distance to stop because the spring brakes do not work on all axles. Lightly loaded vehicles or vehicles on slippery roads may skid out of control when the spring brakes come on. It is much safer to stop while there is enough air in the tanks to use the foot brakes.

5.4.8 Parking Brakes

Any time you park, use the parking brakes, except as noted below. Pull the parking brake control knob out to apply the parking brakes, push it in to release. The control will be a yellow, diamond-shaped knob labeled “parking brakes” on newer vehicles. On older vehicles, it may be a round blue knob or some other shape (including a lever that swings from side to side or up and down).

Don’t use the parking brakes if the brakes are very hot (from just having come down a steep grade), or if the brakes are very wet in freezing temperatures. If parking brakes are used while the brakes are very hot, they can be damaged by the heat. If they are used in freezing temperatures when the brakes are very wet, they can freeze so the vehicle cannot move. Use wheel chocks to hold the vehicle. Let hot brakes cool before using the

parking brakes. If the brakes are wet, use the brakes lightly while driving in a low gear to heat and dry them.

If your vehicle does not have automatic air tank drains, drain your air tanks at the end of each working day to remove moisture and oil, otherwise the brakes could fail.

Never leave your vehicle unattended without applying the parking brakes or chocking the wheels. Your vehicle might roll away and cause injury and damage.

Subsection 5.4

Test Your Knowledge

1. Why should you be in the proper gear before starting down a hill?
2. What factors can cause brakes to fade or fail?
3. The use of brakes on a long, steep downgrade is only a supplement to the braking effect of the engine. True or False?
4. If you are away from your vehicle only a short time, you do not need to use the parking brake. True or False?
5. How often should you drain air tanks?
6. How do you brake when you drive a tractor-trailer combination with ABS?
7. You still have normal brake functions if your ABS is not working. True or False?

These questions may be on your test. If you can’t answer them all, re-read subsection 5.4

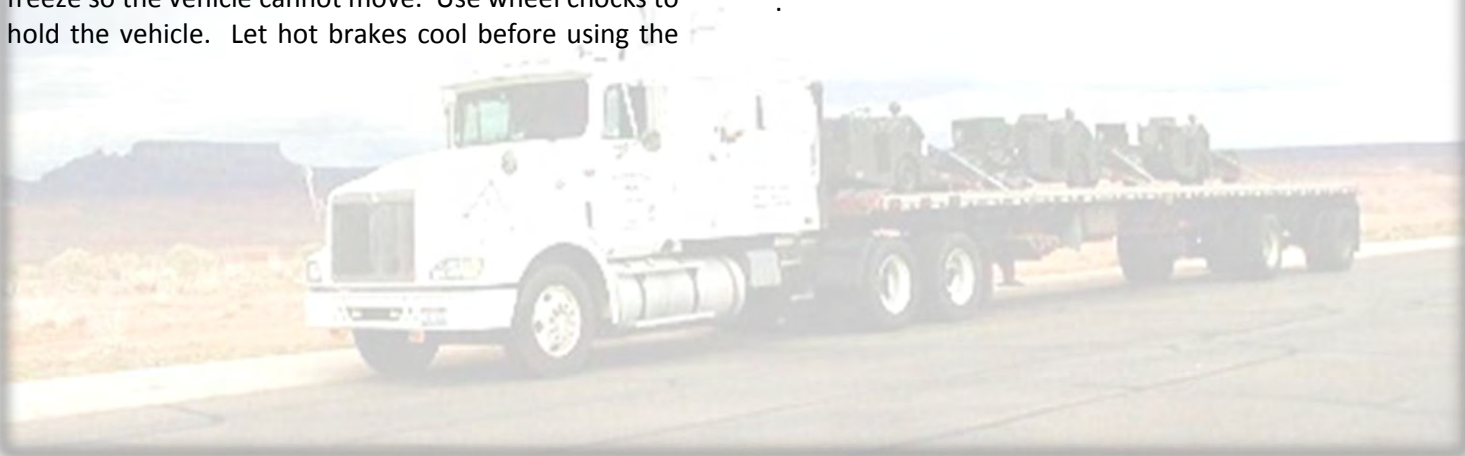

Chapter 6 : Combination Vehicles

This Chapter Covers:



- Driving Combinations**
- Combination Vehicle Air Brakes**
- Antilock Brake Systems**
- Coupling and Uncoupling**
- Inspecting Combinations**

This chapter provides information needed to pass the tests for combination vehicles (tractor-trailer, doubles, triples, straight truck with trailer). The information is only to give you the minimum knowledge needed for driving common combination vehicles. You should also study Chapter 7 if you need to pass the test for doubles and triples.

6.1 DRIVING COMBINATION VEHICLES SAFELY

“TROUBLE FOLLOWS!” These are words to live by when towing any type of trailer(s). You must pay close attention to what is happening to your trailer(s) and cargo (if visible) as you drive through various traffic, road and weather conditions. If you don’t pay attention, your trailer(s) will most assuredly cause you severe problems and maybe your life or the lives of others.

Combination vehicles are usually heavier, longer, and require more driving skill than single commercial vehicles. This means that drivers of combination vehicles need more knowledge and skill than drivers of single vehicles. In this section, we talk about some important safety factors that apply specifically to combination vehicles.

6.1.1 Rollover Risks

More than half of truck driver deaths in crashes are the result of truck rollovers. When more cargo is piled up in a truck, the “center of gravity” moves higher up from the road. The truck becomes easier to turn over. Fully loaded vehicles are ten times more likely to roll over in a crash than empty vehicles. The following two things will help you prevent rollover, 1) keep the cargo as close

to the ground as possible, and 2) drive slowly around turns. Keeping cargo low is even more important in combination vehicles than in straight trucks. Also, keep the load centered on your vehicle. If the load is to one side so it makes a trailer lean, a rollover is more likely. Make sure your cargo is centered and spread out as much as possible (Cargo distribution is covered in Chapter 3 of this manual).

Rollovers happen when you turn too fast. Drive slowly around corners, on ramps, and off ramps. Avoid quick lane changes, especially when fully loaded.

6.1.2 Steer Gently

Trucks with trailers have a dangerous “crack-the-whip” effect. When you make a quick lane change, the crack-the-whip effect can turn the trailer over. There are many accidents where only the trailer has overturned.

“Rearward amplification” causes the crack-the-whip effect **Figure 6.1** shows eight types of combination vehicles and the rearward amplification each has in a quick lane change. Vehicles with the least crack-the-whip effect are shown at the top and those with the most, at the bottom. Rearward amplification of 2.0 in the chart means that the rear trailer is twice as likely to turn over as the tractor. You can see that triples have a rearward amplification of 3.5. This means you can roll the last trailer of triples 3.5 times as easily as a five-axle tractor.

Steer gently and smoothly when you are pulling trailers. If you make a sudden movement with your steering wheel, your trailer could tip over. Follow far enough behind other vehicles (at least 1 second for each 10 feet of your vehicle length, plus another second if going over 40 mph). Look far enough down the road to avoid being surprised and having to make a sudden lane change. At night, drive slowly enough to see obstacles with your headlights before it is too late to change lanes or stop gently. Slow down to a safe speed before going into a turn.

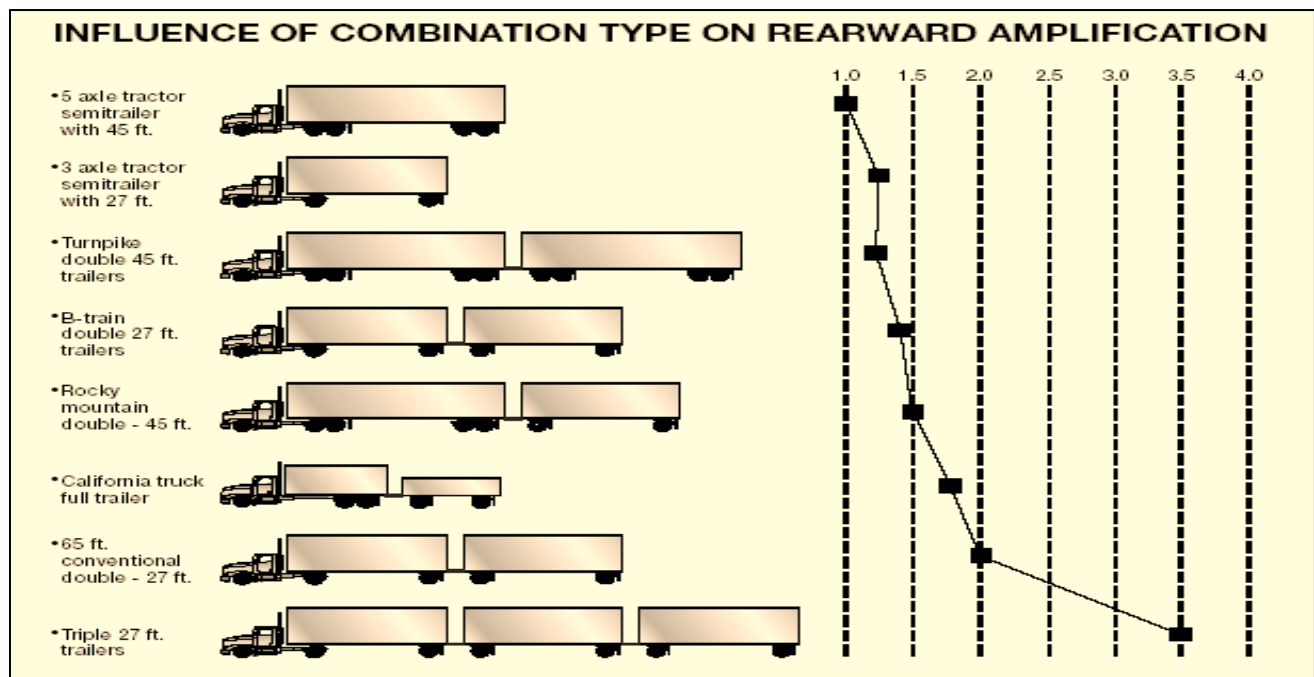

Figure 6.1

6.1.3 Brake Early

Control your speed whether fully loaded or empty. Large combination vehicles take longer to stop when they are empty than when they are fully loaded. When lightly loaded, the very stiff suspension springs and strong brakes give poor traction and make it very easy to lock up the wheels. Your trailer can swing out and strike other vehicles. Your tractor can jackknife very quickly. You also must be very careful about driving “bobtail” tractors (tractors without semitrailers). Tests have shown that bobtails can be very hard to stop smoothly. It takes them longer to stop than a tractor-semitrailer loaded to maximum gross weight.

In any combination vehicle, allow lots of following distance and look far ahead, so you can brake early. Don't be caught by surprise and have to make a “panic” stop.

6.1.4 Railroad-highway Crossings

Railroad-highway crossings can also cause problems, particularly when pulling trailers with low underneath clearance. These trailers can get stuck on raised crossings:

- Low-slung units (lowboy, car carrier, moving van, possum-belly livestock trailer).

- Single-axle tractor pulling a long trailer with its landing gear set to accommodate a tandem-axle tractor.

If for any reason you get stuck on the tracks, get out of the vehicle and away from the tracks. Check signposts or signal housing at the crossing for emergency notification information. Call 911 or other emergency number and give the location of the crossing using all identifiable landmarks, especially the DOT number, if posted.

6.1.5 Prevent Trailer Skids

When the wheels of a trailer lock up, the trailer will tend to swing around. This is more likely to happen when the trailer is empty or lightly loaded. This type of jackknife is often called a “trailer jackknife” (See Figure 6.2).

The procedure for stopping a trailer skid is the following:

Recognize the Skid. The earliest and best way to recognize that the trailer has started to skid is by seeing it in your mirrors. Any time you apply the brakes hard, check the mirrors to make sure the trailer is staying where it should be. Once the trailer swings out of your lane, it's very difficult to prevent a jackknife.

Stop Using the Brake. Release the brakes to get traction back. Do not use the trailer hand brake (if you have one) to “straighten out the vehicle.” This is the wrong thing to do since the brakes on the trailer wheels caused the skid in the first place. Once the trailer wheels grip the road again, the trailer will start to follow the tractor and straighten out.

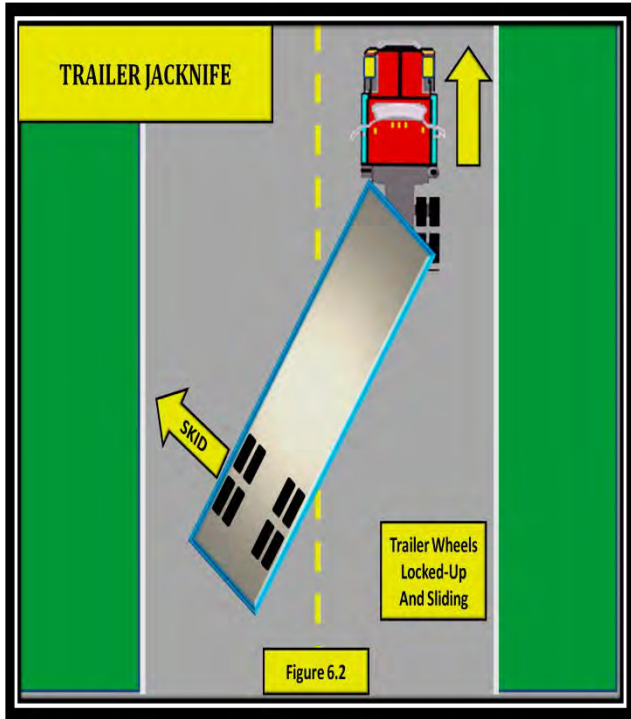

6.1.6 Turn Wide For Off-Tracking

One of the greatest causes of accidents in the trucking industry is due to trailer off-tracking (i.e. sideswiping a car at an intersection while turning). Off-tracking is when a vehicle makes a turn and its rear wheels do not follow the same path as its front wheels. The difference between the front axle path and the rear axle path of the vehicle increases with the spacing between the axles and decreases for larger radius turns. Off-tracking of passenger cars is negligible because of their relatively short wheelbases; however, combination trucks and trailers off-track considerably. From the second a driver places his/her truck in gear at the beginning of the day until they shut it off at night, off-tracking issues will be a constant concern and challenge. There are two types of off-tracking. Low-speed off-tracking occurs when the vehicle is traveling at low speeds and negotiating turns, such as intersections. High-speed off-tracking occurs on the open road at highway speeds.

Low-Speed Off-tracking: When a combination vehicle makes a low-speed turn (90-degree intersection) the

wheels of the rearmost trailer axle follow a path several feet inside the path of the tractor’s steering axle. This is called low-speed off-tracking (See Figure 6.3).

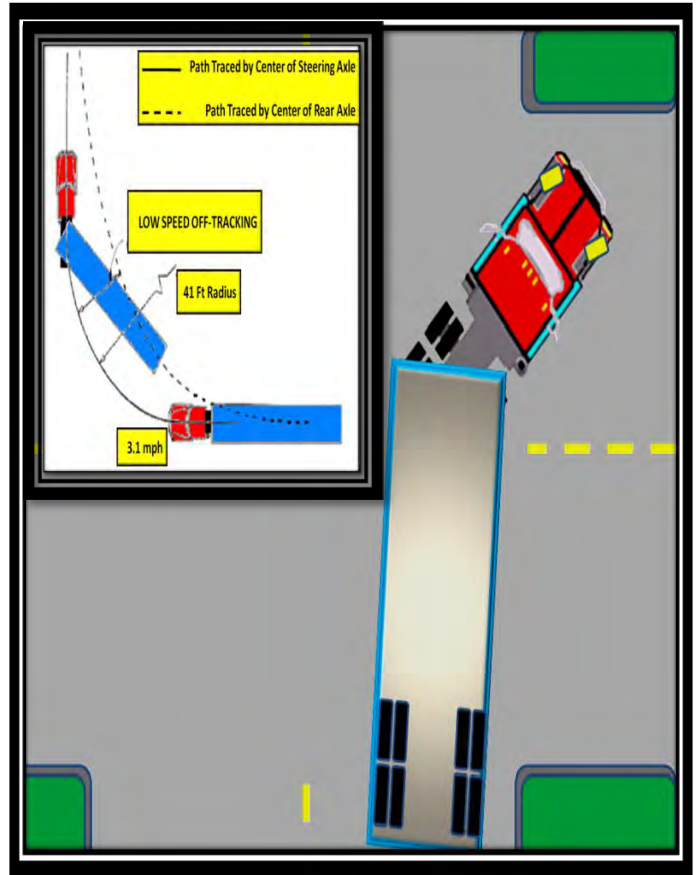

Figure 6.3 – Low Speed Off-tracking

Excessive low-speed off-tracking may make it necessary for the driver to swing wide into adjacent lanes when making a turn to avoid climbing curbs, striking fixed objects, vehicles or pedestrians. When making a turn to the right at an intersection, keep the rear of your vehicle close to the curb. This maneuver will stop other drivers from passing you on the right and getting caught between you and the curb. If you cannot complete your turn without entering another traffic lane, utilize the on-coming traffic lane in the direction you are turning to complete the turn (**Button Hook Method see Figure 6.4**). If at all possible, do not make a turn by swinging out into on-coming traffic before initiating the turn (**Jug Handle Method see Figure 6.4**).

There are instances; however, where the road is too narrow and the turn at the intersection is too tight to utilize the Button Hook Method. On these occasions you will be forced to use the Jug Handle Method to complete the turn successfully; however, these instances are rare. You must use the Button Hook Method if at all possible, because it is the safest and

most practical way to complete a turn successfully. When using exit ramps, excessive off-tracking can result in the trailer(s) tracking inward onto the shoulder or over curbs.

The amount of off-tracking truck and trailer(s) combinations experience is due to two key factors: (1) the distance from the tractor fifth wheel and trailer kingpin attachment (pivot point) to the center of the trailer(s) rear axle or axle group, and (2) the amount of sideways drag of the rear tires.

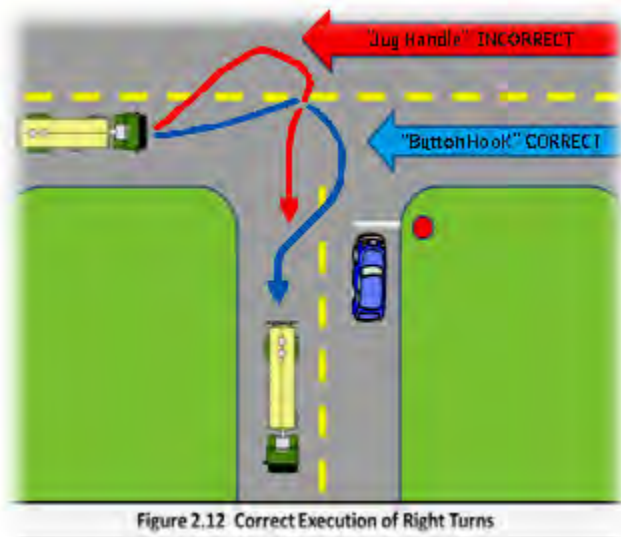

Figure 2.12 Correct Execution of Right Turns

Pivot Points: In the case of double and triple trailer combinations, the overall length of the combination is broken up by multiple pivot points. Because of the multiple pivot points and the utilization of trailers with shorter wheelbases, the standard double-trailer combination (two 28-foot trailers) and triple-trailer combination (three 28-foot trailers) will have better low speed off-tracking performance than a standard tractor and 53-foot semitrailer combination.

Sideways Drag: Sideways drag of the rear tires increases the amount of off-tracking a vehicle will experience. Sideways drag increases with the number of tires on the ground; therefore, tandem axles will have more sideways drag and greater off-tracking than does a single rear axle.

High-Speed Off-tracking: High-speed off-tracking is the tendency of the rear of the trailer(s) to move outward due to the lateral acceleration of the truck as it follows a curve at higher speeds (See Figure 6.3A). As the speed of the truck increases through the curve, the trailer will drift to the inside of the curve at the slower speed and move outward as speed increases until the rear trailer axles follow exactly the tractor steering axle.

At still higher speeds, the rear trailer axles will track outside the track of the tractor steering axle. The speed dependent component of off-tracking is primarily a function of the spacing between truck axles, the speed of the truck, and the radius of the turn. It also depends on the loads carried by the truck axles and the truck suspension characteristics. Figure 6.3A illustrates high-speed off-tracking for a standard tractor-semitrailer.

Figure 6.3A High-Speed Off-tracking

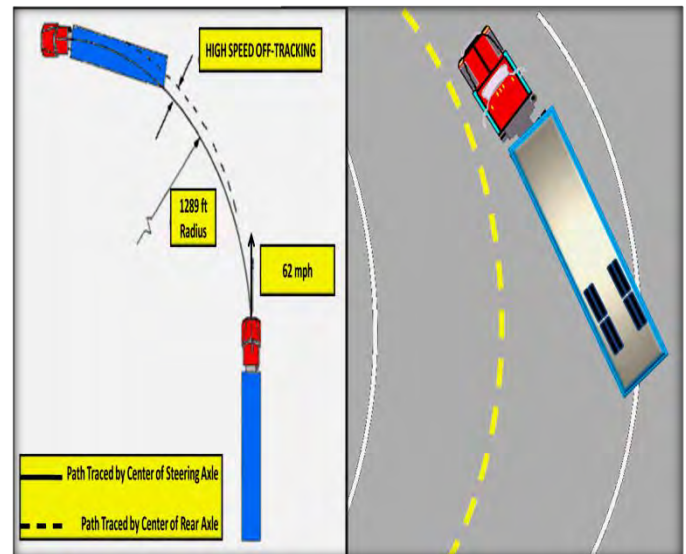

Swept Path: “Swept path” is the amount of roadway space the truck needs to make the turn without hitting something. The most appropriate descriptor of off-tracking for many roadway design applications is the “Swept Path Width.” This is shown in Figure 6.3B as the difference in paths between the outside front tractor tire and the inside rear trailer tire(s) of the vehicle. The maximum swept path is equal to the width of the vehicle plus the off-tracking distance. If this maximum swept path is greater than the width of the travel lane, the vehicle will encroach into adjacent lanes, onto the shoulder, or run off the road during the turning maneuver.

As we have discussed in previous sections, the distance of the truck fifth wheel and trailer kingpin connection (pivot point or kingpin setting) to the center of the trailer’s rear axle group is critical in calculating the off-tracking characteristics of different types of truck and trailer(s) combinations. Kingpin settings can be changed by the driver for various reasons by moving the fifth wheel or sliding the rear axles of the trailer forward or backward.

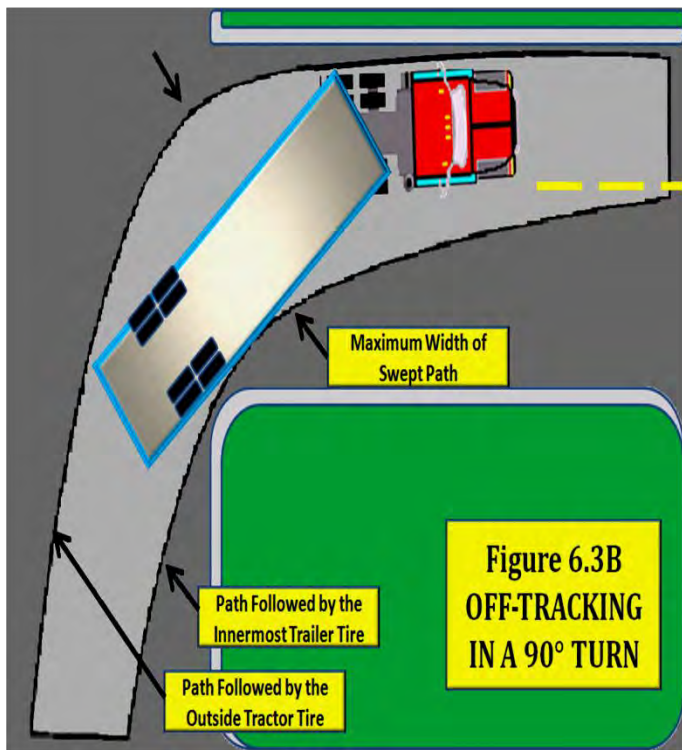

kingpin settings are introduced to various truck and trailer configurations. As an example, the truck and trailer combinations with two (2) and three (3) short trailers off-track less than a tractor with a 41-foot kingpin setting and a 48-foot trailer. The two (2) semitrailer combinations with lengths of 53-feet and 57.5 feet show the sensitivity of off-tracking to the kingpin setting. A 53-foot semitrailer with a 41-foot kingpin setting would off-track the same as the 48-foot semitrailer combination, but the back of the trailer would swing out a little further due to the additional 5 feet from the center of its trailer axle group to the back of the trailer.

The effect of having multiple pivot points can be seen by comparing the off-tracking of the 57.5-foot semitrailer with that of the Rocky Mountain Double, a combination with 53-foot trailer, and a 28-foot trailer which has an additional 23.5 feet in cargo box length. The combination with the worst off-tracking characteristics is the Turnpike Double with two (2) 53-foot trailers.

The table in **Figure 6.4A** will help you understand what off-tracking characteristics will occur when various

Truck Configuration	Trailer Length(s) (feet)	Kingpin Setting(s) (feet)	Offtracking (feet)	Swept Path (feet)	Encroachment to Inside of Track (feet)
Five-Axle Semitrailer	48.0	41.0	14.2	21.8	10.4
	53.0	46.0	16.5	24.2	12.8
	57.5	50.5	18.7	26.4	15.0
Six-Axle Semitrailer	53.0	44.0	15.6	23.2	11.8
Five-Axle Double	28 & 28	21.9	8.4	16.1	4.7
		21.9			
Seven-Axle Rocky Mtn. Double	53 & 28	46.0	18.9	26.6	15.2
		23.0			
Eight-Axle B-Train Double	33 & 33	32.2	14.2	21.9	10.4
		27.1			
Nine-Axle Turnpike Double	53 & 53	46.0	27.0	34.7	23.2
		46.0			
Seven-Axle Triple	28, 28, 28	23.0	12.7	20.4	9.0
		23.0			
		23.0			

Figure 6.4A Off-tracking Table

12-foot lanes, 60-foot curb return, 38-foot path radius

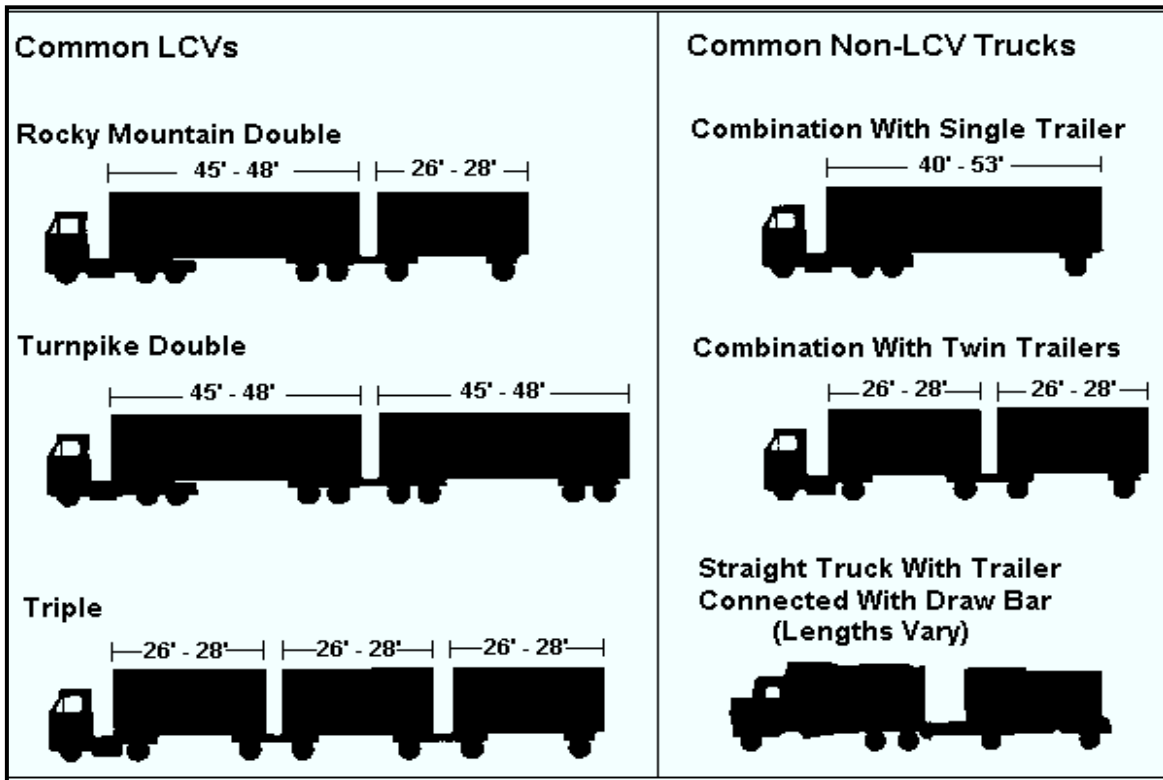

Figure 6.4 Common Combination Vehicles

Highway Restrictions: We have discussed the various off-tracking situations a driver will experience every day he/she operates a large commercial vehicle. Knowing what off-tracking is, and how it affects your vehicle, will help you understand the reason behind highway restrictions. Transportation engineers take into consideration several factors when determining the type and size of vehicles a highway can safely support. Two (2) of the factors engineers consider when setting restrictions on a highway, is the off-tracking and swept path characteristics of the various truck and trailer combinations. Narrow, mountain roads with steep grades and sharp curves present unique challenges for both the driver and the engineer.

Figure 6.4B is a regulatory sign stating the legally allowed vehicle combinations lengths that can operate on



a specific highway or section of highway. Vehicles in excess of the listed dimensions may operate on a highway or section of highway with an over-legal permit. The permit will contain additional operating requirements that must be met such as off-tracking and overall length restrictions. These additional requirements help to ensure the vehicle configuration remains in the lane of travel and not drift into oncoming traffic. Figure 6.4B also reinforces the principle that a single truck and trailer combination has greater off-tracking and swept path issues than the double trailer combination.

6.1.7 Backing with a Trailer

When backing a car, straight truck, or bus, you turn the top of the steering wheel in the direction you want to go. When backing a trailer, you turn the steering wheel in the opposite direction. Once the trailer starts to turn, you must turn the wheel the other way to follow the trailer.

Whenever you back up with a trailer, try to position your vehicle so you can back in a straight line. If you must back on a curved path, back to the driver's side so you can see (See Figure 6.5).

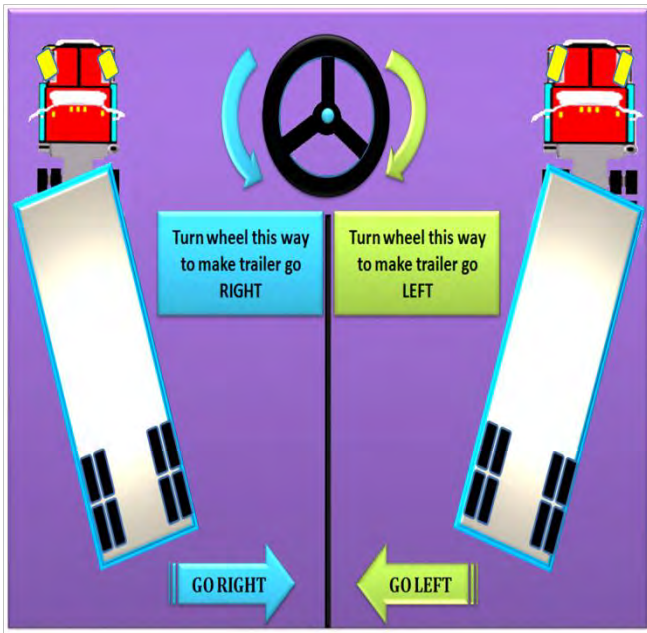

Figure 6.5 Backing a Trailer

Special Note: If you steer with your hand on the bottom of the steering wheel to back up a trailer, you will not have any difficulty determining which direction the trailer will go. Move your hand to the left, and the rear of the trailer will go LEFT. Move your hand to the right, and the rear of the trailer will go RIGHT.

Look at Your Path: Look at your line of travel before you begin. Get out and walk around the vehicle. Check your clearance to the sides and overhead, in and near the path your vehicle.

Use Mirrors on Both Sides: Check the outside mirrors on both sides frequently. Get out of the vehicle and re-inspect your path if you are unsure.

Back Slowly: This will let you make corrections before you get too far off course.

Correct Drift Immediately: As soon as you see the trailer getting off the proper path, correct it by turning the top of the steering wheel in the direction of the drift.

Pull Forward: When backing a trailer, make pull-ups to reposition your vehicle as needed.

Subsection 6.1

Test Your Knowledge

1. What two things are important to prevent rollover?
2. When you turn suddenly while pulling doubles, which trailer is most likely to turn over?
3. Why should you not use the trailer hand brake to straighten out a jackknifing trailer?
4. What is off-tracking?
5. When you back a trailer, you should position your vehicle so you can back in a curved path to the driver's side. True or False?
6. What type of trailers can get stuck on railroad-highway crossings?

These questions may be on your test. If you can't answer them all, re-read subsection 6.1.

6.2 COMBINATION VEHICLE AIR BRAKES

You should study Chapter 5: Air Brakes before reading this section. In combination vehicles, the braking system has parts to control the trailer brakes in addition to the parts previously described in Chapter 5. These parts are described below.

6.2.1 Trailer Hand Valve

The trailer hand valve (also called the Trolley Valve or Johnson Bar) operates the trailer(s) brakes only and is entirely independent of the tractor brakes. The trailer hand valve should be used only to test the trailer brakes. Do not use it in driving because of the danger of making the trailer skid. The foot brake sends air to all of the brakes on the vehicle (including the trailer(s)). There is much less danger of causing a skid or jackknife when using just the foot brake. Never use the hand valve for parking, because all the air might leak out unlocking the brakes (in trailers that don't have spring brakes). Always use the parking brakes when parking. If the trailer does not have spring brakes, use wheel chocks to keep the trailer from moving.

(See Figure 6.5.A)



The Trailer Hand Valve on this International tractor is located on the steering column.
Figure 6.5.A

6.2.2 Tractor Protection Valve

The tractor protection valve keeps air in the tractor or truck brake system should the trailer break away or develop a bad leak. The tractor protection valve is controlled by the “trailer air supply” control valve in the cab. The control valve allows you to open and shut the tractor protection valve. The tractor protection valve will close automatically if air pressure is low (in the range of 20 to 45 psi). When the tractor protection valve closes, it stops any air from going out of the tractor. It also lets the air out of the trailer emergency line which causes the trailer emergency brakes to come on. If the emergency brakes are activated, you could possibly lose control of your vehicle (Emergency brakes are covered later).

6.2.3 Trailer Air Supply Control

The trailer air supply control on newer vehicles is a red eight-sided knob, which you use to control the tractor protection valve. You push it in to supply the trailer

with air, and pull it out to shut the air off and put on the trailer emergency brakes. The valve will pop out (thus closing the tractor protection valve) when the air pressure drops into the range of 20 to 45 psi.

Tractor protection valve controls, or “emergency” valves on older vehicles, may not operate automatically. There may be a lever rather than a knob. The “normal” position is used for pulling a trailer. The “emergency” position is used to shut the air off and put on the trailer emergency brakes.

6.2.4 Trailer Air Lines

Every combination vehicle has two air lines, the service line and the emergency line. They run between each vehicle (tractor to trailer, trailer to dolly, dolly to second trailer, etc.)

Service Air Line: The service line (also called the control line or signal line) carries air, which is controlled by the foot brake or the trailer hand brake. Depending on how hard you press the foot brake or pull the hand valve, the pressure in the service line will similarly change. The service line is connected to relay valves. These valves allow the trailer brakes to be applied more quickly than would otherwise be possible.

Emergency Air Line: The emergency line (also called the supply line) has two purposes. First, it supplies air to the trailer air tanks and secondly, the emergency line controls the emergency brakes on combination vehicles. Loss of air pressure in the emergency line causes the trailer emergency brakes to come on. The pressure loss could be caused by a trailer breaking loose, thus tearing apart the emergency air hose, or it could be caused by a hose, metal tubing, or other part breaking, letting the air out. When the emergency line loses pressure, it also causes the tractor protection valve to close (the air supply knob will pop out).

Emergency lines are often coded with the color red (red hose, red couplers, or other parts) to keep from getting them mixed up with the blue service line.

6.2.5 Hose Couplers (Glad Hands)

“Glad hands” are coupling devices used to connect the service and emergency air lines from the truck or tractor to the trailer. The couplers have a rubber seal, which prevents air from escaping. Clean the couplers and rubber seals before a connection is made. When

connecting the glad hands, press the two seals together with the couplers at a 90-degree angle to each other. A turn of the glad hand attached to the hose will join and lock the couplers.

When coupling, make sure to couple the proper glad hands together. To help avoid mistakes, colors are sometimes used. Blue is used for the service lines and red for the emergency (supply) lines. Sometimes, metal tags are attached to the lines with the words “service” and “emergency” stamped on them (See Figure 6.6).

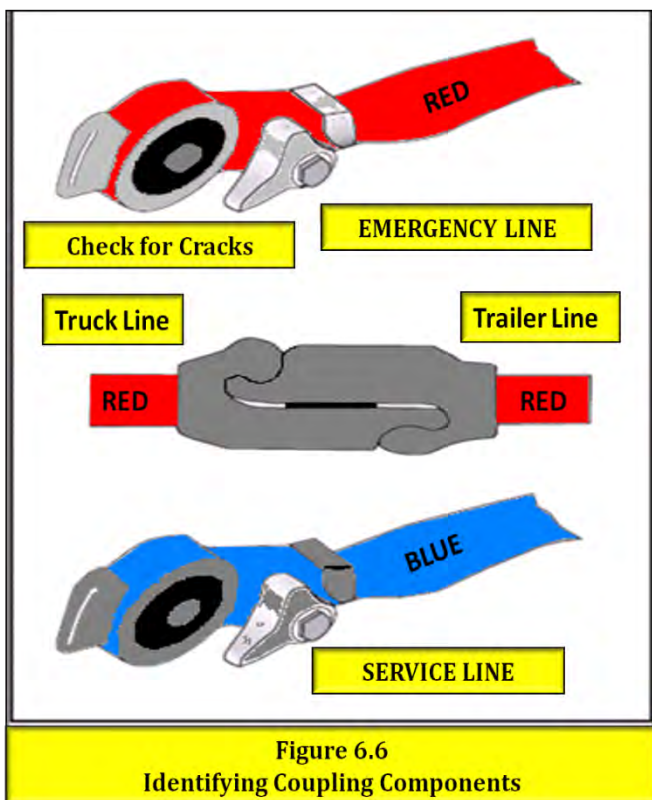

If you do cross the air lines, supply air will be sent to the service line instead of going to charge the trailer air tanks. Air will not be available to release the trailer spring brakes (parking brakes). If the spring brakes don't release when you push the trailer air supply control, check the air line connections.

Older trailers do not have spring brakes. If the air supply in the trailer air tank has leaked away there will be no emergency brakes, and the trailer wheels will turn freely. If you crossed the air lines, you could drive away but you wouldn't have trailer brakes. This would be very dangerous. Always test the trailer brakes before driving with the hand valve or by pulling the air supply (tractor protection valve) control. Pull gently against them in a low gear to make sure the brakes work. Some vehicles have “dead end” or dummy couplers to which the hoses may be attached when they

are not in use. This will prevent water and dirt from getting into the coupler and the air lines. Use the dummy couplers when the air lines are not connected to a trailer. If there are no dummy couplers, the glad hands can sometimes be locked together (depending on the couplings). It is very important to keep the air supply clean.

6.2.6 Trailer Air Tanks

Each trailer and converter dolly has one or more air tanks. They are filled by the emergency (supply) line from the tractor. They provide the air pressure used to operate trailer brakes. Air pressure is sent from the air tanks to the brakes by relay valves.

The pressure in the service line tells how much pressure the relay valves should send to the trailer brakes. The pressure in the service line is controlled by the brake pedal and the trailer hand brake.

It is important that you don't let water and oil build up in the air tanks. If you do, the brakes may not work correctly. Each tank has a drain valve on it, and you should drain each tank every day. If your tanks have automatic drains, they will keep most moisture out, but you should still open the drains to make sure.

6.2.7 Shut-off Valves

Shut-off valves (also called “cut-out cocks”) are used in the service and supply air lines at the back of trailers used to tow other trailers. These valves permit closing the air lines off when another trailer is not being towed. You must check that all shut-off valves are in the open position except the ones at the back of the last trailer, which must be closed.

6.2.8 Trailer Service, Parking, and Emergency Brakes

Newer trailers have spring brakes just like trucks and truck tractors; however, converter dollies and trailers built before 1975 are not required to have spring brakes. Those that do not have spring brakes have emergency brakes, which work from the air stored in the trailer air tank. The emergency brakes come on whenever air pressure in the emergency line is lost. These trailers have no parking brake. The emergency brakes come on whenever the air supply knob is pulled out or the trailer is disconnected.

A major leak in the emergency line will cause the tractor protection valve to close and the trailer emergency brakes to come on, but the brakes will hold only as long as there is air pressure in the trailer air tank. Eventually, the air will leak away and then there will be no brakes; therefore, it is very important for safety that you use wheel chocks when you park trailers without spring brakes.

You may not notice a major leak in the service line until you try to put the brakes on. Then, the air loss from the leak will lower the air tank pressure quickly. If it goes low enough, the trailer emergency brakes will come on.

Subsection 6.2

Test Your Knowledge

1. Why should you not use the trailer hand valve while driving?
2. Describe what the trailer air supply control does.
3. Describe what the service line is for.
4. What is the emergency air line for?
5. Why should you use chocks when parking a trailer without spring brakes?
6. Where are shut-off valves?

These questions may be on your test. If you can't answer them all, re-read subsection 6.2.

6.3 ANTILOCK BRAKE SYSTEMS

6.3.1 Trailers Required to Have ABS

All trailers and converter dollies built on or after March 1, 1998 are required to have ABS; however, many trailers and converter dollies built before this date have been voluntarily equipped with the system.

Trailers will have yellow ABS malfunction lamps on the left side, either on the front or rear corner (**See Figure 6.7**). Dollies manufactured on or after March 1, 1998 are required to have a lamp on the left side.

In the case of vehicles manufactured before the required date, it may be difficult to tell if the unit is equipped with ABS. Look under the vehicle for the ECU

and wheel speed sensor wires coming from the back of the brakes.

6.3.2 Braking with ABS

ABS is an addition to your normal brakes. It does not decrease or increase your normal braking capability. ABS only activates when wheels are about to lock up.

ABS does not necessarily shorten your stopping distance, but it does help you keep the vehicle under control during hard braking.

ABS helps you avoid wheel lock up. The computer senses impending lockup, reduces the braking pressure to a safe level, and you maintain control.

Having ABS on only the trailer, or even on only one axle, still gives you more control over the vehicle during braking.



When only the trailer has ABS, the trailer is less likely to swing out, but if you lose steering control or start a tractor jackknife, let up on the brakes (if you can safely do so) until you regain control.

Figure 6.7 – ABS Test Light. The Amber Light will come on and stay on if there is a problem with the ABS System

When you drive a tractor-trailer combination with ABS, you should brake as you always have. In other words:

- Use only the braking force necessary to stop safely and stay in control.
- Brake the same way, regardless of whether you have ABS on the tractor, the trailer, or both.
- As you slow down, monitor your tractor and trailer and back off the brakes (if it is safe to do so) to stay in control.

Remember, if your ABS malfunctions, you still have regular brakes. Drive normally, but get the system

serviced soon. ABS *won't* allow you to drive faster, follow more closely, or drive less carefully.

6.4 COUPLING AND UNCOUPLING

Knowing how to couple and uncouple correctly is basic to safe operation of combination vehicles. Wrong coupling and uncoupling can be very dangerous. General coupling and uncoupling steps are listed below. There are differences between different vehicles, so learn the details of coupling and uncoupling the truck(s) you will operate.

6.4.1 Coupling Tractor-Semitrailers

Step 1: Inspect Fifth Wheel



- Check for damaged/missing parts.
- Check to see that mounting to tractor is secure, no cracks in frame, etc.
- Be sure that the fifth wheel plate is greased as required. Failure to keep the fifth wheel plate lubricated could cause steering problems because of friction between the tractor and trailer.

Check if fifth wheel is in proper position for coupling:



- Wheel tilted down toward rear of tractor.
- Jaws open.
- Safety unlocking handle in the automatic lock position.
- If you have a sliding fifth wheel, make sure it is locked.
- Make sure the trailer kingpin is not bent or broken.

Step 2: Inspect Area and Chock Wheels

- Make sure area around the vehicle is clear.
- Be sure trailer wheels are chocked or spring brakes are on.
- Check that cargo (if any) is secured against movement due to tractor being coupled to the trailer.

Step 3: Position Tractor

- Put the tractor directly in front of the trailer. Never back under the trailer at an angle because you might push the trailer sideways and break the landing gear.
- Check position, using outside mirrors, by looking down both sides of the trailer.

Step 4: Back Slowly

- Back until fifth wheel just touches the trailer.
- Don't hit the trailer.

Step 5: Secure Tractor

- Put on the parking brake.
- Put transmission in neutral.

Step 6: Check Trailer Height

- The trailer should be low enough that it is raised slightly by the tractor when the tractor is backed under it. Raise or lower the trailer as



needed. If the trailer is too low, the tractor may strike and damage the trailer nose. If the trailer is too high, it may not couple correctly.

- Check that the kingpin and fifth wheel are aligned.

Step 7: Connect Air Lines to Trailer

- Check glad hand seals and connect tractor emergency air line to trailer emergency glad hand.



- Check glad hand seals and connect tractor service air line to trailer service glad hand.
- Make sure air lines are safely supported where they won't be crushed or caught while the tractor is backing under the trailer.



Step 8: Supply Air to Trailer

- From cab, push in "air supply" knob or move tractor protection valve control from the "emergency" to the "normal" position to supply air to the trailer brake system.
- Wait until the air pressure is normal.
- Check brake system for crossed air lines.
- Shut engine off so you can hear the brakes.
- Apply and release trailer brakes and listen for sound of trailer brakes being applied and released. You should hear the brakes move when applied and air escape when the brakes are released.
- Check air brake system pressure gauge for signs of major air loss.
- When you are sure trailer brakes are working, start the engine.
- Make sure air pressure is up to normal.

Step 9: Lock Trailer Brakes

- Pull out the "air supply" knob or move the tractor protection valve control from "normal" to "emergency."

Step 10: Back Under Trailer

- Use lowest reverse gear.

- ⦿ Back tractor slowly under trailer to avoid hitting the kingpin too hard.
- ⦿ Stop when the kingpin is locked into the fifth wheel.

Step 11: Check Connection for Security

- ⦿ Raise trailer landing gear slightly off ground.
- ⦿ Pull tractor gently forward while the trailer brakes are still locked to check that the trailer is locked onto the tractor.



Step 12: Secure Vehicle

- ⦿ Put transmission in neutral.
- ⦿ Put parking brakes on.
- ⦿ Shut off engine and take the key with you so someone else won't move truck while you are under it.

Step 13: Inspect Coupling

- ⦿ Use a flashlight, if necessary.



- ⦿ Make sure there is no space between the apron on the trailer and the fifth wheel skid plate. If there is space, something is wrong (kingpin may be on top of the closed fifth wheel jaws, and trailer would come loose easily).

- ⦿ Go under trailer and look into the back of the fifth wheel. Make sure the fifth wheel jaws have closed around the shank of the kingpin. Check that the fifth wheel locking lever is in the "lock" position.



- ⦿ Check that the safety latch is in position over locking lever (on some fifth wheels the catch must be put in place by hand).
- ⦿ If the coupling isn't right, don't drive the coupled unit, get it fixed.



Step 14: Connect Electrical Cord/ Check Air

- ⦿ Plug the electrical cord into the trailer and fasten the safety catch.
- ⦿ Check both air lines and electrical line for signs of damage.
- ⦿ Make sure air and electrical lines will not hit any moving parts of the vehicle.

Step 15: Raise Trailer Landing Gear

- Use low gear range (if so equipped) to begin raising the landing gear. Once free of weight, switch to the high gear range.



- Raise the landing gear all the way up. Never drive with landing gear only part way up as it may catch on railroad tracks or other things.
- After raising landing gear, secure the crank handle safely.
- When the full weight of the trailer is resting on tractor:
 -  Check for enough clearance between rear of tractor frame and landing gear (when the tractor turns sharply, it must not hit the landing gear).
 -  Check that there is enough clearance between the top of the tractor tires and the nose of the trailer.

Step 16: Remove Trailer Wheel Chocks

- Remove and store wheel chocks in a safe place.

6.4.2 Uncoupling Tractor-Semitrailers

The following steps will help you to uncouple safely:

Step 1: Position Vehicle

- Make sure surface of parking area can support weight of trailer.
- Have tractor lined up with the trailer (pulling out at an angle can damage landing gear).

Step 2: Ease Pressure on Locking Jaws

- Shut off trailer air supply to lock trailer brakes.
- Ease pressure on fifth wheel locking jaws by backing up gently. This will help you release the fifth wheel locking lever.
- Put parking brakes on while tractor is pushing against the kingpin. This will hold the vehicle with pressure off the locking jaws.

Step 3: Chock Trailer Wheels

- Chock the trailer wheels if the trailer doesn't have spring brakes or if you're not sure. The air could leak out of the trailer air tank, releasing its emergency brakes. Without chocks, the trailer could move.

Step 4: Lower the Landing Gear

- If the trailer is empty, lower the landing gear until it makes firm contact with the ground.
- If the trailer is loaded, after the landing gear makes firm contact with the ground, turn crank in low gear a few extra turns (about 7 turns). This will lift some weight off the tractor. Do not lift trailer off the fifth wheel. This will:
 - Make it easier to unlatch fifth wheel.
 - Make it easier to couple next time.

Step 5: Disconnect Air Lines & Electrical Cable

- Disconnect air lines from trailer. Connect air line glad hands to dummy couplers at back of cab or couple them together.
- Hang electrical cable with plug down to prevent moisture from entering it.
- Make sure lines are supported so they won't be damaged while driving the tractor.

Step 6: Unlock Fifth Wheel

- Raise the release handle lock.
- Pull the release handle to "open" position.
- Keep legs and feet clear of the rear tractor wheels to avoid serious injury in case the vehicle moves.

Step 7: Pull Tractor Partially Clear of Trailer

- Pull tractor forward until fifth wheel comes out from under the trailer.
- Stop with the tractor frame under the trailer (prevents trailer from falling to ground if landing gear should collapse or sink).

Step 8: Secure Tractor

- Apply parking brake.
- Place transmission in neutral.

Step 9: Inspect Trailer Supports

- Make sure the ground is supporting the trailer.
- Make sure the landing gear is not damaged.

Step 10: Pull Tractor Clear of Trailer

- Release parking brakes.
- Check the area and drive tractor forward until it clears.

Subsections 6.3 and 6.4

Test Your Knowledge

1. What might happen if the trailer is too high when you try to couple?
2. After coupling, how much space should be between the trailer apron and fifth wheel plate?
3. You should look into the back of the fifth wheel to see if it is locked onto the kingpin. True or False?
4. To drive you need to raise the landing gear only until it just lifts off the pavement. True or False?
5. How do you know if your trailer is equipped with antilock brakes?

These questions may be on your test. If you can't answer them all, re-read subsections 6.3 and 6.4.

6.5 INSPECTING A COMBINATION VEHICLE



Use the seven-step inspection procedure described in Chapter 2 to inspect your combination vehicle. There are more things to inspect on a combination vehicle than on a single vehicle (for example, tires, wheels, lights, reflectors, etc.); however, there are also some new things to check, which are discussed in this section.

6.5.1 Additional Things to Check During a Walk-Around Inspection



Do these checks in addition to those already listed in Chapter 2.

Coupling System Areas:

Check fifth wheel (lower):

-  Securely mounted to frame.
-  No missing or damaged parts.
-  Enough grease.



-  No visible space between trailer apron and fifth wheel plate.
-  Locking jaws around the shank, not the head of kingpin (**See Figure 6.8**).
-  Release arm properly seated and safety latch/lock engaged.

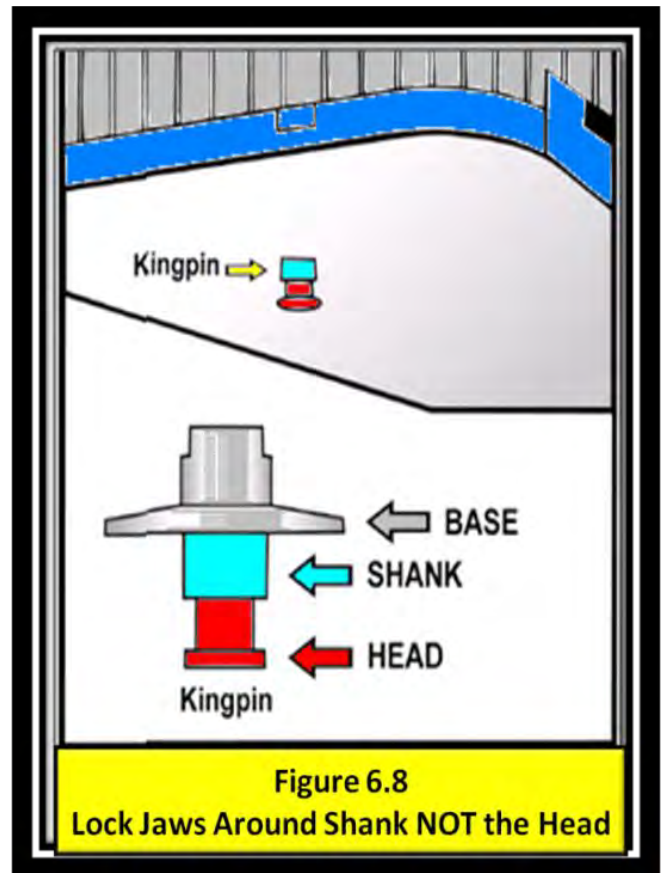

Check fifth wheel (upper):



-  Glide plate securely mounted to trailer frame.







-  Kingpin not damaged.



Air and electric lines to trailer:



-  Electrical cord firmly plugged in and secured.
-  Air lines properly connected to glad hands, no air leaks, properly secured with enough slack for turns.
-  All lines free from damage.

Sliding fifth wheel:

-  Slide not damaged or parts missing.
-  Properly greased.
-  All locking pins present and locked in place.
-  If air powered - no air leaks.
-  Check that fifth wheel is not so far forward that tractor frame will hit landing gear, or the cab will hit the trailer during turns.



Landing Gear

-  Fully raised, no missing parts, not bent or otherwise damaged.
-  Crank handle in place and secured.
-  If power operated, no air or hydraulic leaks.

6.5.2 Combination Vehicle Brake Check

Do these checks in addition to Section 5.3, Inspecting Air Brake Systems.

The following section explains how to check air brakes on combination vehicles. Check the brakes on a double or triple trailer as you would any combination vehicle.

Check That Air Flows to All Trailers: Use the tractor parking brake and/or chock the wheels to hold the vehicle. Wait for air pressure to reach normal, then push in the red “trailer air supply” knob. This will supply air to the emergency (supply) lines. Use the trailer handbrake to provide air to the service line. Go to the rear of the vehicle and open the emergency line shut-off valve at the rear of the last trailer. You should hear air escaping; thereby, showing the entire system is charged. Close the emergency line valve. Open the service line valve to check that service pressure goes through all the trailers (this test assumes that the trailer handbrake or the service brake pedal is on), and then close the valve. If you do NOT hear air escaping from both lines, check to see that the shut-off valves on the trailer(s) and dolly(s) are in the OPEN position. You MUST have air all the way to the back of the last trailer in the combination for all the brakes to work.

Test Tractor Protection Valve: Charge the trailer air brake system (that is, build up normal air pressure and push the “air supply” knob in). Shut the engine off and step on and off the brake pedal several times to reduce the air pressure in the tanks. The trailer air supply control (also called the tractor protection valve control) should pop out (or go from “normal” to “emergency” position) when the air pressure falls into the pressure range specified by the manufacturer (usually within the range of 20 to 45 psi).

If the tractor protection valve doesn’t work right, an air hose or trailer brake leak could drain all the air from the tractor. This would cause the emergency brakes to come on and result in a possible loss of control of the vehicle.

Test Trailer Emergency Brakes: Charge the trailer air brake system and check that the trailer rolls freely. Then stop and pull out the trailer air supply control (also called tractor protection valve control or trailer emergency valve), or place it in the “emergency” position. Pull gently on the trailer with the tractor to check that the trailer emergency brakes are on.

Test Trailer Service Brakes: Check for normal air pressure, release the parking brakes, move the vehicle forward slowly, and apply trailer brakes with the hand control (trolley valve), if so equipped. You should feel the brakes come on. This tells you the trailer brakes are connected and working. (The trailer brakes should be tested with the hand valve but controlled in normal operation with the foot pedal, which applies air to the service brakes at all wheels).

Subsection 6.5

Test Your Knowledge

1. Which shut-off valves should be open and which closed?
2. How can you test that air flows to all trailers?
3. How can you test the tractor protection valve?
4. How can you test the trailer emergency brakes?
5. How can you test the trailer service brakes?

These questions may be on your test. If you can't answer all of them, re-read subsection 6.5.

Chapter 7 : Doubles and Triples

This Chapter Covers:



Pulling Double/Triple Trailers
Coupling and Uncoupling
Inspecting Doubles and Triples
Checking Air Brakes

This chapter has information you need to pass the CDL knowledge test for driving safely with double and triple trailers. It tells about how important it is to be very careful when driving with more than one trailer, how to couple and uncouple correctly, and about inspecting doubles and triples carefully (you should also study Chapters 2, 5, and 6).

7.1 PULLING DOUBLE/TRIPLE TRAILERS

Take special care when pulling two and three trailers. There are more things that can go wrong, and doubles/triples are less stable than other commercial vehicles. Some areas of concern are discussed below.

7.1.1 Prevent Trailer from Rolling Over

To prevent trailers from rolling over, you must steer gently and go slowly around corners, on ramps, off ramps, and curves. A safe speed on a curve for a straight truck or a single trailer combination vehicle may be too fast for a set of doubles or triples.

7.1.2 Beware of the Crack-the-Whip Effect

Doubles and triples are more likely to turn over than other combination vehicles because of the “crack-the-whip” affect. You must steer gently when pulling trailers. The last trailer in a combination is most likely to turn over. If you don't understand the crack-the-whip affect, study subsection 6.1.2 of this manual.

7.1.3 Inspect Completely

There are more critical parts to check when you have two or three trailers. Check them all and follow the procedures described later in this section.

7.1.4 Look Far Ahead

Doubles and triples must be driven very smoothly to avoid rollover or jackknife; therefore, look far ahead so you can slow down or change lanes gradually when necessary.

7.1.5 Manage Space

Doubles and triples take up more space than other commercial vehicles. They are not only longer, but also need more space because they can't be turned or stopped suddenly. **Allow more following distance and make sure you have large enough gaps before entering or crossing traffic. Be certain you are clear at the sides before changing lanes.**

Of all the space around your vehicle, it is the area ahead of the vehicle - the space you're driving into - that is most important.

The Need for Space Ahead: You need space ahead in case you must suddenly stop. According to accident reports, the vehicle that trucks and buses most often run into is the one in front of them. The most frequent cause is following too closely. Remember, if the vehicle ahead of you is smaller than yours, it can probably stop faster than you can. You may crash if you are following too closely.

How Much Space? How much space should you keep in front of you? One good rule says you need at least one second for each 10 feet of vehicle length at speeds below 40 mph. At greater speeds, you must add one second for safety. For example, if you are driving a 40-foot vehicle, you should leave four seconds between you and the vehicle ahead. In a 60-foot vehicle, you'll need six seconds. Over 40 mph, you'd need five seconds for a 40-foot vehicle and seven seconds for a 60-foot vehicle (**See Figure 7.A**). To know how much space you have, wait until the vehicle ahead passes a shadow on the road, a pavement marking, or some other clear landmark, then count off the seconds like this: “one thousand-one, one thousand-two,” and so on, until you reach the same spot. Compare your count with the rule of one second for every ten feet of length.

If you are driving a 40-foot truck and only counted up to two seconds, you're too close. Drop back a little and count again until you have 4 seconds of following distance (or 5 seconds, if you're going over 40 mph). After a little practice, you will know how far back you should be. **Remember to add one second for speeds above 40 mph. Also remember that when the road is slippery, you need much more space to stop.**

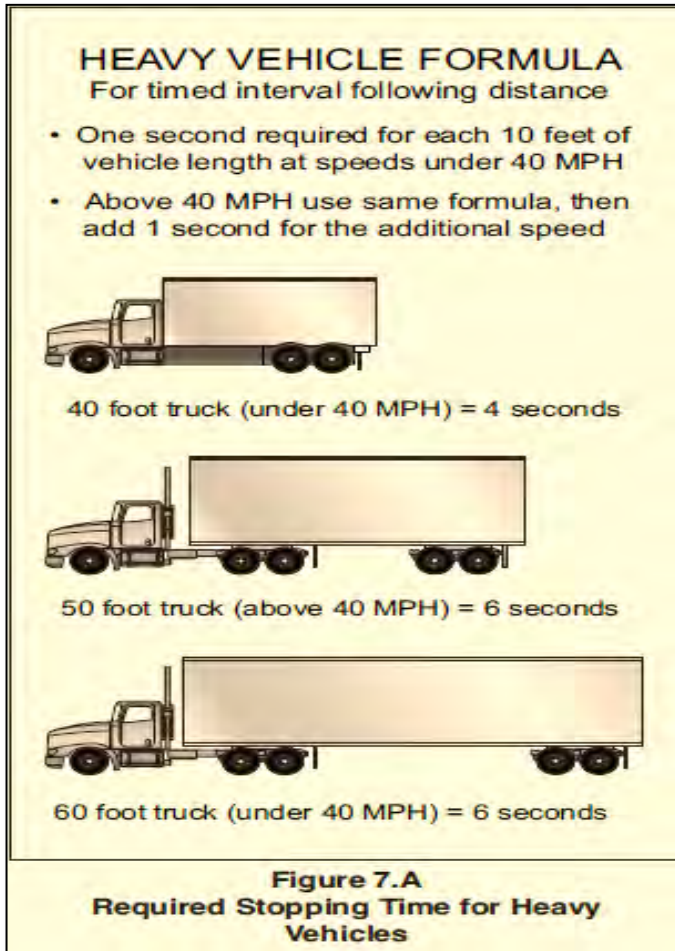

7.1.6 Adverse Conditions

Be more careful in adverse conditions. In bad weather, slippery conditions, and mountain driving, you must be especially careful if you drive double and triple bottoms. You will have greater length and more dead axles to pull with your drive axles than other drivers. There is more chance for skids and loss of traction.

7.1.7 Parking the Vehicle

Make sure you do not get in a spot you cannot pull straight through. You need to be aware of how parking lots are arranged in order to avoid a long and difficult escape.

7.1.8 Antilock Braking Systems on Converter Dollies

Converter dollies built on or after March 1, 1998, are required to have antilock brakes. These dollies will have a yellow lamp on the left side of the dolly.

7.2 COUPLING AND UNCOUPLING

Knowing how to couple and uncouple correctly is basic to safe operation of doubles and triples. Wrong coupling and uncoupling can be very dangerous. Coupling and uncoupling steps for doubles and triples are listed below.

7.2.1 Coupling Twin Trailers

Secure Second (Rear) Trailer

If the second trailer doesn't have spring brakes, drive the tractor close to the trailer, connect the emergency line, charge the trailer air tank, and disconnect the emergency line. This will set the trailer emergency brakes (if the slack adjusters are correctly adjusted). Chock the wheels if you have any doubt about the brakes. For the safest handling on the road, the more heavily loaded semitrailer should be in first position behind the tractor, and the lighter trailer should be in the rear.

A converter gear on a dolly is a coupling device of one or two axles and a fifth wheel by which a semitrailer can be coupled to the rear of a tractor-trailer combination forming a double bottom vehicle (See Figure 7.1).

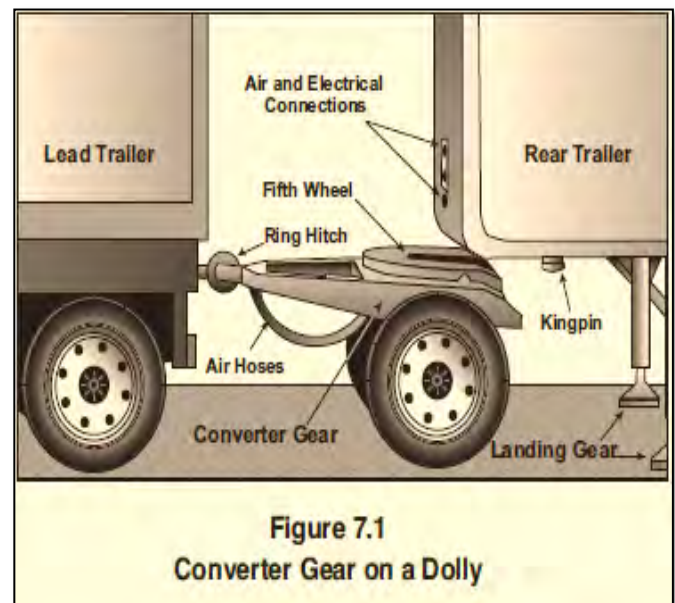

Position Converter Dolly in Front of Second (Rear) Trailer

Release dolly brakes by opening the air tank petcock (valve), or if the dolly has spring brakes, use the dolly parking brake control.

If the distance is not too great, wheel the dolly into position by hand so it is in line with the kingpin. If the distance is too far between the dolly and the trailer, use the tractor and first semitrailer to pick up the converter dolly:



- Position combination as close as possible to converter dolly.
- Move dolly to rear of first semitrailer and couple it to the trailer.



- Lock pintle hook.



- Secure dolly support in raised position.
- Pull dolly into position as close as possible to nose of the second semitrailer.
- Lower the dolly support.
- Unhook the dolly from the first trailer.
- Wheel the dolly into position in front of the second trailer in line with the kingpin.

Connect Converter Dolly to Front Trailer

- Back first semitrailer into position in front of dolly tongue.



- Hook dolly to front trailer.
 - Lock pintle hook.
 - Secure converter gear support in raised position.

Connect Converter Dolly to the Rear Trailer



- Make sure the trailer brakes are locked and/or wheels chocked.
- Make sure the trailer height is correct (it must be slightly lower than the center of the fifth wheel, so the trailer is raised slightly when the dolly is pushed under it).



- Back the converter dolly under the rear trailer.
- Raise the landing gear slightly off of the ground to prevent damage if the trailer moves.

- Test the coupling by pulling against the pin of the second semitrailer.
- Make a visual check of coupling (no space between the trailer apron and the fifth wheel plate, and the locking jaws are closed around the kingpin).
- Connect the safety chains, air hoses, and light cords.



- Close the converter dolly air tank petcock (valve). Also close the service and emergency air shut-off valves at the rear of the second trailer.



- Open the service and emergency air shut-off valves at rear of the first trailer and on the converter dolly (if so equipped).

- Raise the landing gear completely.
- Charge the trailer brakes (push “air supply” knob in), and check for air at rear of second trailer by opening the emergency air line shut-off. If air pressure isn't there, something is wrong and the brakes won't work.



- Slowly drive the tractor forward with the first semitrailer and dolly still attached in order to pull the dolly out from under the rear semitrailer.

Uncouple Converter Dolly

- Lower the dolly landing gear.
- Disconnect the safety chains.
- Apply the converter gear spring brakes or chock the wheels.
- Release the pintle hook on the first semi-trailer.
- Slowly pull clear of the dolly.

Never unlock the pintle hook with the dolly still under the rear trailer. The dolly tow bar may fly up, possibly causing you injury, and making it very difficult to re-couple the equipment.

7.2.2 Uncoupling Twin Trailers

Uncouple Rear Trailer

- Park the vehicle in a straight line on firm level ground.
- Apply the parking brakes so the vehicle won't move.
- Chock the wheels of the second trailer if it doesn't have spring brakes.
- Lower the landing gear of the second semitrailer enough to remove some of the weight from the dolly.
- Close the air shut-off valves at the rear of the first semitrailer (and on the dolly if so equipped).
- Disconnect all of the dolly air and electric lines and secure them.
- Release the dolly brakes.
- Release converter dolly fifth wheel latch.

7.2.3 Coupling and Uncoupling Triple Trailers

Couple Tractor & First Semitrailer to Second, Third Trailers

- Couple the tractor to the first trailer. Use the method already described for coupling tractor-semitrailers.
- Move the converter dolly into position and couple first trailer to second trailer using the method for coupling doubles. The triple trailer combination is now complete.

Uncouple Triple-trailer Combination

- Uncouple the third trailer by pulling the dolly out, then unhitching the dolly using the method for uncoupling doubles.
- Uncouple the remainder of the vehicle as you would any double-bottom vehicle using the method already described.

7.2.4 Coupling & Uncoupling Other Combinations

The methods described so far apply to the more common tractor-trailer combinations. However, there are other ways of coupling and uncoupling the many

types of truck-trailer and tractor-trailer combinations that are in use. There are too many to cover in this manual. You must learn the right way to couple the vehicle(s) you will drive according to the manufacturer and/or owner.

7.3 INSPECTING DOUBLES AND TRIPLES







Use the seven-step inspection procedure described in Chapter 2 to inspect your combination vehicle. There are more things to inspect on a combination vehicle than on a single vehicle. Many of these items are simply more of what you would find on a single vehicle (for example, tires, wheels, lights, reflectors, etc.); however, there are also some new things to check. These are discussed below.

7.3.1 Additional Checks





Do these checks in addition to those already listed in Chapter 2, Step 5: Do the Walk-around Inspection.

Coupling System Areas

Check fifth wheel (lower):

-  Securely mounted to frame.
-  No missing or damaged parts.
-  Enough grease.
-  No visible space between trailer apron and fifth wheel plate.
-  Locking jaws around the shank, not the head, of the kingpin.
-  Fifth wheel release arm properly seated and safety latch/lock engaged.





Check fifth wheel (upper):

-  Glide plate (apron) securely mounted to the trailer frame.
-  Kingpin not damaged.
-  Air and electric lines to trailer.
-  Electrical cord firmly plugged in and secured.



-  Air lines properly connected to glad hands, no air leaks, properly secured with enough slack for turns.

-  All lines free from damage.

Sliding fifth wheel:

-  Slide not damaged or parts missing.
-  Properly greased.
-  All locking pins present and locked in place.
-  If air powered, no air leaks.
-  Check that fifth wheel is not so far forward that tractor frame will hit the landing gear, or the cab of the tractor hit the trailer during turns.

Landing Gear:

-  Fully raised, no missing parts, not bent or otherwise damaged.
-  Crank handle in place and secured.
-  If power operated, no air or hydraulic leaks.

Double and Triple Trailers:

-  Shut-off valves (at rear of trailers, in service and emergency lines).
 - Rear of front trailers: OPEN.
 - Rear of last trailer: CLOSED.
 - Converter dolly air tank drain valve: CLOSED.
- Be sure air lines are supported and glad hands are properly connected.
- If spare tire is carried on converter gear (dolly), make sure it's secured.
- Be sure pintle-eye of dolly is in place in pintle hook of trailer(s).
- Make sure pintle hook is latched.

- Safety chains should be secured to trailer(s).
- Be sure light cords are firmly in sockets on trailers.

7.3.2 Additional Things to Check During a Walk-Around Inspection

Do these checks in addition to subsection 5.3, Inspecting Air Brake Systems.

7.4 DOUBLES/TRIPLES AIR BRAKE CHECK

Check the brakes on a double or triple trailer as you would any combination vehicle. Subsection 6.5.2 explains how to check air brakes on combination vehicles. You must also make the following checks on your double or triple trailers.

7.4.1 Additional Air Brake Checks

Check That Air Flows to All Trailers (Double and Triple Trailers): Use the tractor parking brake and/or chock the wheels to hold the vehicle. Wait for the air pressure to reach normal, then push in the red “trailer air supply” knob. This will supply air to the emergency (supply) lines. Use the trailer handbrake to provide air to the service line. Go to the rear of the vehicle and open the emergency line shut-off valve at the rear of the last trailer. You should hear air escaping indicating the entire system is charged. Close the emergency line valve and open the service line valve to check that service pressure goes through all the trailers (this test assumes that the trailer handbrake or the service brake pedal is on), and then close the valve.

If you do NOT hear air escaping from both lines, check that the shut-off valves on the trailer(s) and dolly(s) are in the OPEN position. You MUST have air all the way to the back of the last trailer in the combination for all the brakes to work.

Test Tractor Protection Valve: Charge the trailer air brake system (that is, build up normal air pressure and push the “air supply” knob in). Shut the engine off and step on and off the brake pedal several times to reduce the air pressure in the tanks. The trailer air supply control (also called the tractor protection valve control) should pop out (or go from “normal” to “emergency” position) when the air pressure falls into the pressure

range specified by the manufacturer (usually within the range of 20 to 45 psi).

If the tractor protection valve doesn’t work properly, an air hose or trailer brake leak could drain all the air from the tractor. This would cause the emergency brakes to come on and result in a possible loss of control of the vehicle.

Test Trailer Emergency Brakes: Charge the trailer air brake system and check that the trailer rolls freely. Then stop and pull out the trailer air supply control (also called tractor protection valve control or trailer emergency valve) or place it in the “emergency” position. Pull gently on the trailer with the tractor to check that the trailer emergency brakes are on.

Test Trailer Service Brakes: Check for normal air pressure, release the parking brakes, move the vehicle forward slowly, and apply the trailer brakes with the hand control (trolley valve), if so equipped. You should feel the brakes come on. This tells you the trailer brakes are connected and working. The trailer brakes should be tested with the hand valve, but controlled in normal operation with the foot pedal, which applies air to the service brakes at all wheels.)

7.5 LONG COMMERCIAL VEHICLE (LCV) CERTIFICATION

Special Note: FMCSRs §380.113 – Employer responsibilities; §380.201 – General requirements; §380.203 - LCV Doubles, and §380.205 – LCV Triples outline the special training and certification requirements an employer and driver must follow before the driver can legally operate vehicles towing double and/or triple trailers.

Section 7

Test Your Knowledge

1. What is a converter dolly?
2. Do converter dollies have spring brakes?
3. What three methods can you use to secure a second trailer before coupling?
4. How do you check to make sure the trailer height (apron to fifth wheel) is correct before coupling?

5. What do you check when making a visual check of coupling?
6. Why should you pull a dolly out from under a trailer before you disconnect it from the trailer in front?
7. What should you check for when inspecting the converter dolly? The pintle hook?
8. Should the shut-off valves on the rear of the last trailer be open or closed? On the first trailer in

a set of doubles? On the middle trailer of a set of triples?

9. How can you test that air flows to all trailers?
10. How do you know if your converter dolly is equipped with antilock brakes?

These questions may be on your test. If you can't answer them all, re-read Chapter 7.



Chapter 8 : Tank Vehicles

This Chapter Covers:



Inspecting Tank Vehicles

Driving Tank Vehicles

Safe Driving Rules

This chapter has information needed to pass the CDL knowledge test for driving a tank vehicle (you should also study Chapters 2, 5, and 6). A tank endorsement is required for certain vehicles that transport liquids or gases. The liquid or gas does not have to be a hazardous material. A tank endorsement is only required if your vehicle needs a Class A or B CDL, and you want to haul a liquid or liquid gas in a permanently mounted cargo tank rated at 119 gallons or more or a portable tank rated at 1,000 gallons or more. A tank endorsement is also required for Class C vehicles when the vehicle is used to transport hazardous materials in liquid or gas form in the above described rated tanks.

Before loading, unloading, or driving a tanker, you must inspect the vehicle. This ensures that the vehicle is safe to carry the liquid or gas and is safe to drive. Be familiar with tank vehicle loading and unloading procedures. Some liquids or gases require that a qualified person be within 25 feet of the tank when unloading.

8.1 INSPECTING TANK VEHICLES

Before loading, unloading, or driving a tanker, you must inspect the vehicle. This assures that the vehicle is safe to carry the liquid or gas and is safe to drive.

Tank vehicles have special items that you need to check. Tank vehicles come in many types and sizes. You need to check the vehicle's operator manual to make sure you know how to inspect your tank vehicle.

8.1.1 Leaks

On all tank vehicles, the most important item to check for is leaks. Check under and around the vehicle for signs of any leaking. Don't carry liquids or gases in a leaking tank, because to do so is a crime. You will be cited and prevented from driving further. You may also be liable for the clean-up of any spill. In general, check the following:

- ✓ Check the tank's body or shell for dents or leaks.
- ✓ Check the intake, discharge, and cut-off valves. Make sure the valves are in the correct position before loading, unloading, or moving the vehicle.
- ✓ Check pipes, connections, and hoses for leaks, especially around joints.
- ✓ Check manhole covers and vents. Make sure the covers have gaskets and they close correctly. Keep the vents clear so they work correctly.

8.1.2 Check Special Purpose Equipment

If your vehicle has any of the following equipment, make sure it works:

- ✓ Vapor recovery kits.
- ✓ Grounding and bonding cables.
- ✓ Emergency shut-off systems.
- ✓ Built in fire extinguisher.

Never drive a tank vehicle with open valves or open manhole covers.

8.1.3 Special Equipment

Check the emergency equipment required for your vehicle. Find out what equipment you're required to carry and make sure you have it (and it works).

8.2 DRIVING TANK VEHICLES

Hauling liquids in tanks requires special skills because of the high center of gravity and the liquid movement (**See Figure 8.1**).

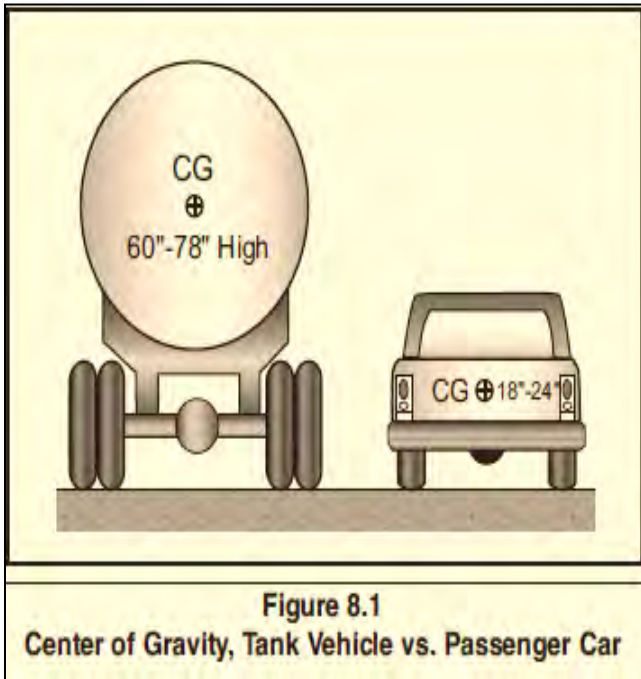

Figure 8.1
Center of Gravity, Tank Vehicle vs. Passenger Car

8.2.1 High Center of Gravity

High center of gravity means that much of the load's weight is carried high up off the road. This makes the vehicle top-heavy and easy to roll over. Liquid tankers are especially easy to roll over. Tests have shown that tankers can turn over at the speed limits posted for curves. Take highway curves and on ramp/off ramp curves well below the posted speeds.

8.2.2 Danger of Surge

Liquid surge results from movement of the liquid in partially filled tanks. This movement can have bad effects on handling. For example, when coming to a stop, the liquid will surge back and forth and when the wave hits the end of the tank, it tends to push the truck in the direction the wave is moving. If the truck is on a slippery surface such as ice, the wave can shove a stopped truck out into an intersection.

The driver of a liquid tanker must be very familiar with the handling characteristics of the vehicle.

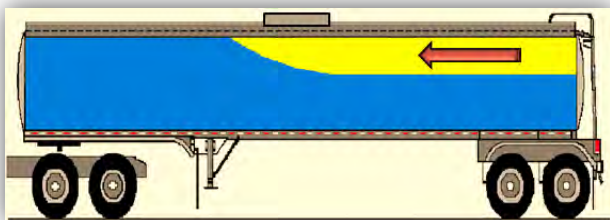

8.2.3 Bulkheads

Some liquid tanks are divided into several smaller tanks by bulkheads. When loading and unloading the smaller tanks, the driver must pay attention to weight distribution. Don't put too much weight on the front or rear of the vehicle.



Fuel Trailer with bulkheads can carry different grades of fuel

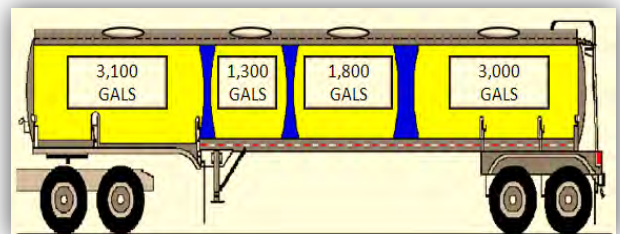

8.2.4 Baffled Tanks

Baffled liquid tanks have bulkheads in them with holes that let the liquid flow through. The baffles help to control the forward and backward liquid surge; however, side-to-side surge can still occur which can cause a rollover.



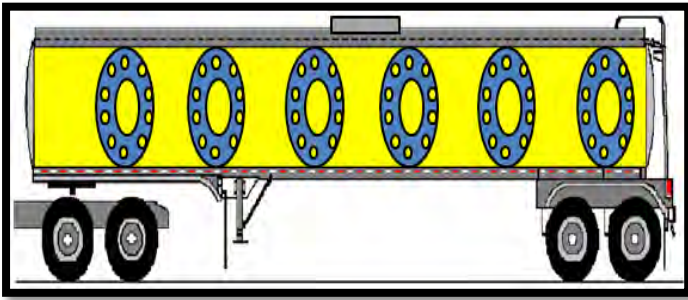

Baffled Liquid Tank

8.2.5 Un-baffled Tanks

Un-baffled liquid tankers (sometimes called “smooth bore” tanks) have nothing inside to slow down the flow of the liquid; therefore, forward-and-back surge is very strong. Un-baffled tanks are usually those that transport food products such as milk (sanitation regulations forbid the use of baffles because of the difficulty in cleaning the inside of the tank). Be extremely cautious (slow and careful) in driving smooth bore tanks, especially when starting and stopping.

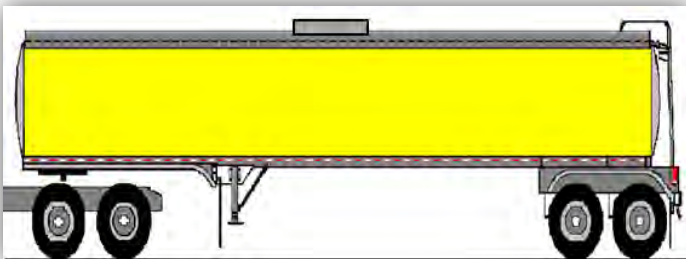

8.2.6 Outage

Never load a cargo tank totally full. Liquids expand as they warm, and you must leave room for the expanding liquid. This is called “outage.” Since different liquids expand by different amounts, they require different amounts of outage. You must know the outage requirement when hauling liquids in bulk.

8.2.7 How Much to Load?

A full tank of dense liquid (such as some acids) may exceed legal weight limits. For that reason, you may often only partially fill the tanks with heavy liquids. The amount of liquid to load into a tank depends on:

- The amount the liquid will expand in transit.
- The weight of the liquid.
- Legal weight limits.

8.3 SAFE DRIVING RULES

In order to drive tank vehicles safely, you must remember to follow all the safe driving rules. A few of these rules include the following:

8.3.1 Drive Smoothly

Because of the high center of gravity and the surge of the liquid, you must start, slow down, and stop very smoothly. You must also make smooth turns and lane changes.

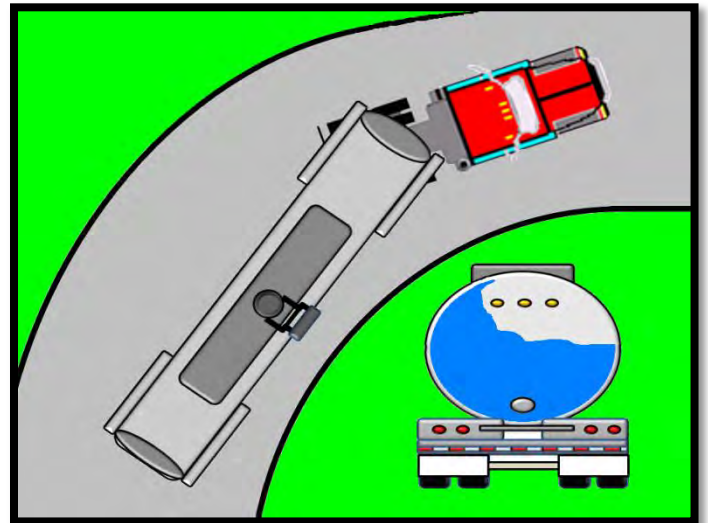

8.3.2 Controlling Surge

Keep a steady pressure on the brakes and do not release them too soon when coming to a stop. Brake far in advance of a stop and increase your following distance.

If you must make a quick stop to avoid a crash, use controlled or stab braking. If you do not remember

how to stop the vehicle by using these braking methods, review subsection 2.17.2. Also, remember that if you steer quickly while braking, your vehicle may roll over.

8.3.3 Curves

Slow down before curves, then accelerate slightly through the curve. The posted speed for a curve may be too fast for a tank vehicle.

8.3.4 Stopping Distance

Keep in mind how much space you need to stop your vehicle. Remember that wet roads double the normal stopping distance. Empty tank vehicles may take longer to stop than full ones.

8.3.5 Skids

Don't over-steer, over-accelerate, or over-brake. If you do, your vehicle may skid. On tank trailers, if your drive wheels or trailer wheels begin to skid, your vehicle may jackknife. When any vehicle starts to skid, you must take immediate action to restore traction to the wheels.

Section 8

Test Your Knowledge









1. How are bulkheads different than baffles?
2. Should a tank vehicle take curves, on ramps, or off ramps at the posted speed limits?
3. How are smooth bore tankers different to drive than those with baffles?
4. What three things determine how much liquid you can load?
5. What is outage?
6. How can you help control surge?
7. What two reasons make special care necessary when driving tank vehicles?

These questions may be on the test. If you can't answer them all, re-read Chapter 8.



Chapter 9 : Hazardous Materials

This Chapter Covers:

-  **The Intent of the Regulations**
-  **Bulk Tank Loading, Unloading, and Marking**
-  **Driver Responsibilities**
-  **Driving and Parking Rules**
-  **Communications Rules**
-  **Emergencies**
-  **Loading and Unloading**
-  **Hazardous Materials Endorsement Process**

You must have a CDL with the hazardous materials (hazmat) endorsement before driving vehicles placarded for hazmat. To get this endorsement, you must pass a written test about hazmat rules and regulations and you must undergo a security threat assessment (background check) as required by the USA PATRIOT Act of 2001. If you intend to keep your hazmat endorsement, you must re-take the written test and pass the background investigation every time you renew your CDL (every 4 years).

The federal Transportation Security Administration (TSA) and the United States Department of Transportation (USDOT) have issued rules that states must follow as part of the threat assessment process. The security threat assessment will include the collection of an individual's fingerprints and verification of United States citizenship or permanent legal presence in the United States. More specific information regarding the threat assessment process can be obtained at any county sheriff's office. Information regarding the application process is also located at the end of this chapter.

Hazardous materials are products that pose a risk to health, safety, and property during transportation. The term often is shortened to HAZMAT, which you may see on road signs, or to HM in government regulations. Hazardous materials include explosives, various types of gas, solids, flammable and combustible liquid, and other materials. Because of the risks involved and the potential consequences these risks impose, all levels of government regulate the handling of hazardous materials.

The Hazardous Materials Regulations (HMR) is found in parts 100 - 185 of title 49 of the Code of Federal

Regulations. The common reference for these regulations is 49 CFR 100 - 185

The Hazardous Materials Table in the regulations contains a list of these items. However, this list is not all-inclusive. Whether or not a material is considered hazardous is based on its characteristics and the shipper's decision on whether or not the material meets a definition of a hazardous material in the regulations.

The regulations require vehicles transporting certain types or quantities of hazardous materials to display diamond-shaped, square on point, warning signs called placards.

This section is designed to assist you in understanding your role and responsibilities in hauling hazardous materials. Due to the constantly changing nature of government regulations, it is impossible to guarantee absolute accuracy of the materials in this section. An up-to-date copy of the complete regulations is essential for you to have. Included in these regulations is a complete glossary of terms.

You must have a commercial driver license (CDL) with a hazardous materials endorsement before you drive any size vehicle that is used to transport hazardous material as defined in 49 CFR 383.5. You must pass a written test about the regulations and requirements to get this endorsement.

Everything you need to know to pass the written test is in this manual, in Chapters 8 & 9. However, this is only a beginning. Most drivers need to know much more on the job. You can learn more by reading and understanding the federal and state rules applicable to hazardous materials, as well as, attending hazardous materials training courses. Your employer, colleges and universities, and various associations usually offer these courses. You can get copies of the Federal Regulations (49 CFR) through your local Government Printing Office bookstore and various industry publishers. Union or company offices often have copies of the rules for driver use. Find out where you can get your own copy to use on the job.

The regulations require training and testing for all drivers involved in transporting hazardous materials. Your employer or a designated representative is required to provide this training and testing. Hazardous materials employers are required to keep a record of training for each employee as long as that employee is working with hazardous materials, and for 90 days thereafter. The regulations require that hazardous materials employees be trained and tested at least once every three years.

All drivers must be trained in the security risks of hazardous materials transportation. This training must include how to recognize and respond to possible security threats.

The regulations also require that drivers have special training before driving a vehicle transporting certain flammable gas materials or highway route controlled quantities of radioactive materials. In addition, drivers transporting cargo tanks and portable tanks must receive specialized training. Each driver's employer or his/her designated representative must provide such training.

Some locations require permits to transport certain explosives or bulk hazardous wastes. States and counties also may require drivers to follow special hazardous materials routes. The federal government may require permits or exemptions for special hazardous materials cargo such as rocket fuel. Find out about permits, exemptions, and special routes for the places you drive.

9.1 THE INTENT OF THE REGULATIONS

9.1.1 Contain the Material





Transporting hazardous materials can be risky. The regulations are intended to protect you, those around you, and the environment. They tell shippers how to package the materials safely and drivers how to load, transport, and unload the material. These are called "containment rules."

9.1.2 Communicate the Risk

To communicate the risk, shippers must warn drivers and others about the material's hazards. The regulations require shippers to put hazard warning labels on packages, provide proper shipping papers, emergency response information, and placards. These steps communicate the hazard to the shipper, the carrier, and the driver.

9.1.3 Assure Safe Drivers and Equipment

In order to obtain a hazardous materials endorsement on a CDL, you must pass a written test about transporting hazardous materials. To pass the test, you must know how to:

-  Identify what are hazardous materials.
-  Safely load shipments.
-  Properly placard your vehicle in accordance with the rules.
-  Safely transport shipments.

Learn the rules and follow them. Following the rules reduces the risk of injury from hazardous materials. Taking shortcuts by breaking rules is unsafe. Non-compliance with regulations can result in fines and jail.

Inspect your vehicle before and during each trip. Law enforcement officers may stop and inspect your vehicle. When stopped, they may check your shipping papers, vehicle placards, and the hazardous materials endorsement on your driver's license, and your knowledge of hazardous materials.

9.2 HAZARDOUS MATERIALS TRANSPORTATION: WHO DOES WHAT?

9.2.1 The Shipper

- Sends products from one place to another by truck, rail, vessel, or airplane.
- Uses the hazardous materials regulations to determine the product's:
 - Proper shipping name.
 - Hazard class.
 - Identification number.
 - Packing group.
 - Correct packaging.
 - Correct label and markings.
 - Correct placards.
- Must package, mark, and label the materials; prepare shipping papers; provide emergency response information; and supply placards.
- Certify on the shipping paper that the shipment has been prepared according to the rules (unless you are pulling cargo tanks supplied by you or your employer).

9.2.2 The Carrier

- Takes the shipment from the shipper to its destination.
- Prior to transportation, checks that the shipper correctly described, marked, labeled, and otherwise prepared the shipment for transportation.

- Refuses improper shipments.
- Reports accidents and incidents involving hazardous materials to the proper government agency.

9.2.3 The Driver

- Makes sure the shipper has identified, marked, and labeled the hazardous materials properly.
- Refuses leaking packages and shipments.
- Placards vehicle when loading, if required.
- Safely transports the shipment without delay.
- Follows all special rules about transporting hazardous materials.
- Keeps hazardous materials shipping papers and emergency response information in the proper place.

9.3 COMMUNICATION RULES

9.3.1 Definitions

Some words and phrases have special meanings when talking about hazardous materials. Some of these may differ from meanings you are used to. The words and phrases in this chapter may be on your test. The meanings of other important words are in the glossary at the end of this chapter.

A material's hazard class reflects the risks associated with it. There are nine different hazard classes. The types of materials included in these nine classes are in **Figure 9.1**.

Hazardous Materials Class			
Class	Division	Name of Class or Division	Examples
1	1.1	Mass Explosion	Dynamite
	1.2	Projection Hazard	Flares
	1.3	Fire Hazard	Display Fireworks
	1.4	Minor Explosion	Ammunition
	1.5	Very Insensitive	Blasting Agents
	1.6	Extremely Insensitive	Explosive Devices
2	2.1	Flammable Gases	Propane
	2.2	Non-Flammable Gases	Helium
	2.3	Poisonous/Toxic Gases	Fluorine, Compressed
3	-	Flammable Liquids	Gasoline
4	4.1	Flammable Solids	Ammonium Picrate,
	4.2	Spontaneously Combustible	Wetted White Phosphorus
	4.3	Dangerous When Wet	Sodium
5	5.1	Oxidizers	Ammonium Nitrate
	5.2	Organic Peroxides	Methyl Ethyl Ketone Peroxide
6	6.1	Poison (Toxic Material)	Potassium Cyanide
	6.2	Infectious Substances	Anthrax Virus
7	-	Radioactive	Uranium
8	-	Corrosives	Battery Fluid
9	-	Miscellaneous Hazardous Materials	Polychlorinated Biphenyls (PCB)
e	-	ORM-D (Other Regulated Material-Domestic)	Food Flavorings, Medicines
-	-	Combustible Liquids	Fuel Oil

Figure 9.1

A shipping paper describes the hazardous materials being transported. Shipping orders, bills of lading, and manifests are all shipping papers. Figure 9.6 shows an example shipping paper.

After an accident or hazardous materials spill or leak, you may be injured and unable to communicate the hazards of the materials you are transporting. Firefighters and police can prevent or reduce the amount of damage or injury at the scene if they know what hazardous materials are being carried. Your life, and the lives of others, may depend on quickly locating the hazardous materials shipping papers. For that reason the rules require:

- Shippers to describe hazardous materials correctly and include an emergency response telephone number on shipping papers.
- Carriers and drivers to quickly identify hazardous materials shipping papers, or keep them on top of other shipping papers and keep the required emergency response information with the shipping papers.
- Drivers to keep hazardous materials shipping papers:
 - In a pouch on the driver's door, or
 - In clear view within immediate reach while the seat belt is fastened while driving, or
 - On the driver's seat when out of the vehicle.

9.3.2 Package Labels

Shippers put diamond-shaped hazard warning labels on most hazardous materials packages. These labels inform others of the hazard. If the diamond label won't fit on the package, shippers may put the label on a tag securely attached to the package. For example, compressed gas cylinders that will not hold a label will have tags or decals. Labels look like the examples in

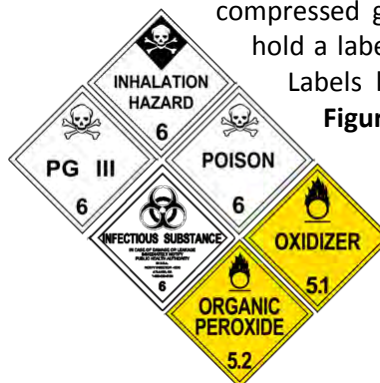
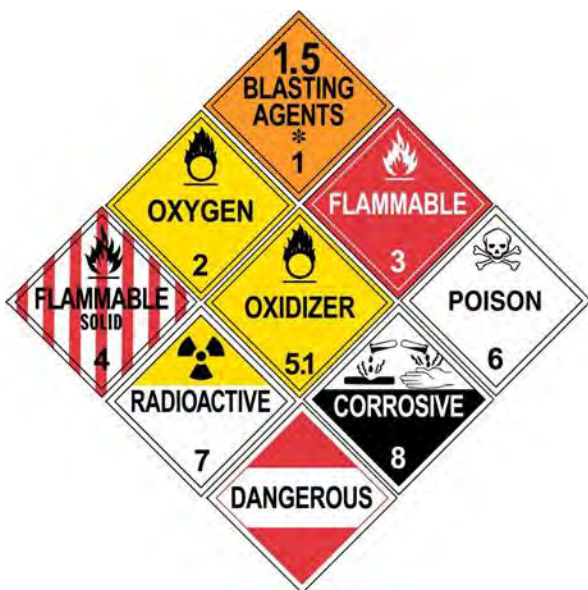

Figure 9.2.

Figure 9.2

9.3.3 Lists of Regulated Products

Placards: Placards are used to warn others of hazardous materials. Placards are signs put on the outside of a vehicle and on bulk packages, which identify the hazard class of the cargo. A placarded vehicle must have at least four identical placards. They are put on the front, rear, and both sides of the vehicle (See Figure 9.3). Placards must be readable from all four directions. They are at least 10 3/4 inches square, square-on-point, in a diamond shape. Cargo tanks and other bulk packaging display the identification number of their contents on placards or orange panels or white square-on-point displays that are the same size as placards.



Examples of HAZMAT Placards Figure 9.3

Identification numbers are a four-digit code used by first responders to identify hazardous materials. An identification number may be used to identify more than one chemical. The letters “NA” or “UN” will precede the identification number. The United States Department of Transportation’s Emergency Response Guidebook (ERG) lists the chemicals and the identification numbers assigned to them.

There are three main lists used by shippers, carriers, and drivers when trying to identify hazardous materials. Before transporting a material, look for its name on three lists. Some materials are on all lists, others on only one. Always check the following lists:

1. Section 172.101, the Hazardous Materials Table.
2. Appendix A to Section 172.101, the List of Hazardous Substances and Reportable Quantities.
3. Appendix B to Section 172.101, the List of Marine Pollutants.

The Hazardous Materials Table: Figure 9.4 shows part of the Hazardous Materials Table. Column 1 tells which shipping mode(s) the entry affects and other information concerning the shipping description. The next five columns show each material's shipping name, hazard class or division, identification number, packaging group, and required labels.

Six different symbols may appear in **Column 1** of the table.

(+) Shows the proper shipping name, hazard class, and packing group to use, even if the material doesn't meet the hazard class definition.

(A) Means the hazardous material described in Column 2 is subject to the HMR only when offered or intended for transport by air unless it is a hazardous substance or hazardous waste.

(W) Means the hazardous material described in Column 2 is subject to the HMR only when offered or intended for transportation by water unless it is a hazardous substance, hazardous waste, or marine pollutant.

(D) Means the proper shipping name is appropriate for describing materials for domestic transportation, but may not be proper for international transportation.

(I) Identifies a proper shipping name that is used to describe materials in international transportation. A different shipping name may be used when only domestic transportation is involved.

(G) Means this hazardous material described in Column 2 is a generic shipping name. A generic

Figure 9.4 49 CFR 172.101 Hazardous Materials Table									
Symbols	Hazardous Materials Description & Proper Shipping Names	Hazard Class or Division	Identification Numbers	PG	Label Codes	Special Provisions (172.102)	Packaging (173.***)		
							Exceptions	Non Bulk	Bulk
(1)	(2)	(3)	(4)	(5)	(6)	(7)	(8A)	(8B)	(8C)
A	Acetaldehyde ammonia	9	UN1841	III	9	IB8, IP6	155	204	240

shipping name must be accompanied by a technical name on the shipping paper. A technical name is a specific chemical that makes the product hazardous.

Column 2 lists the proper shipping names and descriptions of regulated materials. Entries are in alphabetical order so you can more quickly find the right entry. The table shows proper shipping names in regular type. The shipping paper must show proper shipping names. Names shown in italics are not proper shipping names.

Column 3 shows a material's hazard class or division, or the entry "Forbidden." Never transport a "Forbidden" material. Placard hazardous materials shipments based on the quantity and hazard class. You can decide which placards to use if you know these three things:

1. Material's hazard class.
2. Amount being shipped.
3. Amount of all hazardous materials of all classes on your vehicle.

Column 4 lists the identification number for each proper shipping name. Identification numbers are preceded by the letters "UN" or "NA." The letters "NA" are associated with proper shipping names that are only used within the United States and to and from Canada. The identification number must appear on the shipping paper as part of the shipping description and also appear on the package. It also must appear on cargo tanks and other bulk packaging. Police and firefighters use this number to quickly identify the hazardous materials.

Column 5 shows the packing group (in Roman numeral) assigned to a material.

Column 6 shows the hazard warning label(s) shippers must put on packages of hazardous materials. Some products require use of more than one label due to a dual hazard being present.

Column 7 lists the additional (special) provisions that apply to this material. When there is an entry in this column, you must refer to the federal regulations for specific information. The numbers 1-6 in this column mean the hazardous material is a poison inhalation hazard (PIH). PIH materials have special requirements for shipping papers, marking, and placards.

Column 8 is a three-part column showing the section numbers covering the packaging requirements for each hazardous material.

Note: Columns 9 and 10 do not apply to transportation by highway.

Figure 9.5 Appendix A to 49 CFR 172

List of Hazardous Substances And Reportable Quantities

Hazardous Substances	Reportable Quantity (RQ)	
	Pounds	Kilograms
Phenyl mercaptan @	100	(45.4)
Phenylmercury acetate	100	(45.4)
N-Phenylthiourea	100	(45.4)
Phorate	10	(4.54)
Phosgene	10	(4.54)
Phosphine	100	(45.4) *
Phosphoric acid	5000	(2270)
Phosphoric acid, diethyl 4-nitrophenyl ester	100	(45.4)
Phosphoric acid, lead salt	10	(.454)

* Spills of 10 pounds or more must be reported.

Appendix A to 49 CFR 172.101 --The List of Hazardous Substances and Reportable Quantities: The DOT and the EPA want to know about spills of hazardous substances. They are named in the List of Hazardous Substances and Reportable Quantities (See Figure 9.5). Column 3 of the list shows each product's reportable quantity (RQ). When these materials are being transported in a reportable quantity or greater in one package, the shipper displays the letters RQ on the shipping paper and package. The letters RQ may appear before or after the basic description. You or your employer must report any spill of these materials, which occurs in a reportable quantity.

If the words INHALATION HAZARD appear on the shipping paper or package, the rules require display of the POISON INHALATION HAZARD or POISON GAS placards, as appropriate. These placards must be used in addition to other placards, which may be required by the product's hazard class. Always display the hazard class placard and the POISON INHALATION HAZARD placard, even for small amounts.

Appendix B to 49 CFR 172.101 – List of Marine Pollutants

Appendix B is a listing of chemicals that are toxic to marine life. For highway transportation, this list is only used for chemicals in a container with a capacity of 119 gallons or more without a placard or label as specified by the HMR.





Any bulk packages of a Marine Pollutant must display the Marine Pollutant marking (white triangle with a fish and an "X" through the fish). This marking (it is not a placard) must also be displayed on the outside of the vehicle. In addition, a notation must be made on the shipping papers near the description of the material: "Marine Pollutant".

9.3.4 The Shipping Paper

The shipping paper shown in Figure 9.6 describes a shipment. A shipping paper for hazardous materials must include:

- Page numbers if the shipping paper has more than one page. The first page must tell the total number of pages. For example, "Page 1 of 4".
- A proper shipping description for each hazardous material.
- A shipper's certification, signed by the shipper, saying they prepared the shipment according to the regulations.

Figure 9.6 shows a shipping paper where:

-  Phosgene is the proper shipping name from Column 2 of the Hazardous Materials Table.
-  2.3 is the Hazard Class from Column 3 of the Hazardous Materials Table.
-  Un1076 is the Identification Number from Column 4 of the Hazardous materials Table
-  "RQ" means that this is a reportable quantity.

Shipping Paper			
FROM: DEF Corp. 55 High Mountain Dr. Anytown, ID		TO: ABC Chemical Corp. 88 Valley Street Anywhere, VT	Page 1 of 1
Quantity	HM	Description	Weight
1 cylinder	RQ	Phosgene, 2.3, UN1076 Poison, Inhalation Hazard, Zone A	35 lbs.
<i>This is to certify that the above named materials are properly classified, described, packaged marked and labeled, and are in proper condition for transportation according to the applicable regulations of the United States Department of Transportation.</i>			
Shipper: DEF Corporation Per: Bruce W. Date: July 23, 2013		Carrier: Belveal Transport Per: Brad Date: July 25, 2013	
Special Instructions: 24 hour Emergency Contact: D. Jacobsen 1-800-555-5555			

Figure 9.6 – The Shipping Paper

9.3.5 The Item Description

If a shipping paper describes both hazardous and non-hazardous products, the hazardous materials will be either:

- Described first.
- Highlighted in a contrasting color.
- Identified by an "X" placed before the shipping name in a column captioned "HM". The letters "RQ" may be used instead of "X" if a reportable quantity is present in one package.

The basic description of hazardous materials includes the proper shipping name, hazard class or division, the identification number, and the packing group, if any, in that order. The packing group is displayed in Roman numerals and may be preceded by "PG".

Shipping name, hazard class, and identification number must not be abbreviated unless specifically authorized

in the hazardous materials regulations. The description must also show:

- The total quantity and unit of measure.
- The letters RQ, if a reportable quantity.
- If the letters RQ appear, the name of the hazardous substance.
- For all materials with the letter "G" (Generic) in Column 1, the technical name of the hazardous material.

Shipping papers also must list an emergency response telephone number. The emergency response telephone number is the responsibility of the shipper. It can be used by emergency responders to obtain information about any hazardous materials involved in a spill or fire. Some hazardous materials do not need a telephone number. You should check the regulations to determine which do need a telephone number.

Shippers also must provide emergency response information to the motor carrier for each hazardous material being shipped. The emergency response information must be able to be used away from the motor vehicle and must provide information on how to safely handle incidents involving the material. It must include information on the shipping name of the hazardous materials, risks to health, fire, explosion, and initial methods of handling spills, fires, and leaks of the materials.

Such information can be on the shipping paper or some other document that includes the basic description and technical name of the hazardous material. Or, it may be in a guidance book such as the Emergency Response Guidebook (ERG). Motor carriers may assist shippers by keeping an ERG on each vehicle carrying hazardous materials. The driver must provide the emergency response information to any federal, state, or local authority responding to a hazardous materials incident or investigating one.

Total quantity must appear before or after the basic description. The packaging type and the unit of measurement may be abbreviated. For example:

“ 10 ctns. Paint, 3, UN1263, PG II, 500 lbs.”

The shipper of hazardous wastes must put the word WASTE before the proper shipping name of the material on the shipping paper (hazardous waste manifest). For example:

“Waste Acetone, 3, UN1090, PG II. “

A non-hazardous material may not be described by using a hazard class or an identification number.

9.3.6 Shipper's Certification

When the shipper packages hazardous materials, he/she certifies that the package has been prepared according to the rules. The signed shipper's certification appears on the original shipping paper. The only exceptions are when a shipper is a private carrier transporting their own product and when the package is provided by the carrier (for example, a cargo tank). Unless a package is clearly unsafe or does not comply with the HMR, you may accept the shipper's certification concerning proper packaging. Some carriers have additional rules about transporting hazardous materials. Follow your employer's rules when accepting shipments.

9.3.7 Package Markings and Labels

Shippers print required markings directly on the package, an attached label, or tag. An important package marking is the name of the hazardous material. It is the same name as the one on the shipping paper. The requirements for marking vary by package size and material being transported. When required, the shipper will put the following on the package:

- The name and address of shipper or consignee.
- The hazardous material's shipping name and identification number.
- The labels required.

It is a good idea to compare the shipping paper to the markings and labels. Always make sure that the shipper shows the correct basic description on the shipping paper, and verifies that the proper labels are shown on the packages. If you are not familiar with the material, ask the shipper to contact your office.

If rules require it, the shipper will put RQ, MARINE POLLUTANT, BIOHAZARD, HOT, or INHALATION-HAZARD on the package. Packages with liquid containers inside will also have package orientation markings with the arrows pointing in the correct upright direction. The labels used always reflect the hazard class of the product. If a package needs more than one label, the labels must be close together, near the proper shipping name.

9.3.8 Recognizing Hazardous Materials

Learn to recognize shipments of hazardous materials. To find out if the shipment includes hazardous materials, look at the shipping paper. Does it have:

- An entry with a proper shipping name, hazard class, and identification number?
- A highlighted entry or one with an X or RQ in the hazardous materials column?
- Other clues suggesting hazardous materials?
- What business is the shipper in? Paint dealer? Chemical supply? Scientific supply house? Pest control or agricultural supplier? Explosives, munitions, or fireworks dealer?
- Are there tanks with diamond labels or placards on the premises?
- What type of package is being shipped? Cylinders and drums are often used for hazardous materials shipments.
- Is a hazard class label, proper shipping name, or identification number on the package?
- Are there any handling precautions?

9.3.9 Hazardous Waste Manifest

When transporting hazardous wastes, you must sign by hand and carry a Uniform Hazardous Waste Manifest. The name and EPA registration number of the shippers, carriers, and destination must appear on the manifest. Shippers must prepare, date, and sign by hand the manifest. Treat the manifest as a shipping paper when transporting the waste. Only give the waste shipment

to another registered carrier or disposal/treatment facility. Each carrier transporting the shipment must sign by hand the manifest. After you deliver the shipment, keep your copy of the manifest. Each copy must have all needed signatures and dates, including those of the person to whom you delivered the waste.

9.3.10 Placarding

Attach the appropriate placards to the vehicle before you drive it. You are only allowed to move an improperly placarded vehicle during an emergency, in order to protect life or property.

Placards must appear on both sides and both ends of the vehicle. Each placard must be:

- Easily seen from the direction it faces.
- Placed so the words or numbers are level and read from left to right.
- At least three inches away from any other markings.
- Kept clear of attachments or devices such as ladders, doors, and tarpaulins.
- Kept clean and undamaged so that the color, format, and message are easily seen.
- Be affixed to a background of contrasting color.
- The use of “Drive Safely” and other slogans is prohibited.
- The front placard may be on the front of the tractor or the front of the trailer.

To decide which placards to use, you need to know:

- The hazard class of the materials.
- The amount of hazardous materials shipped.
- The total weight of all classes of hazardous materials in your vehicle.

9.3.11 Placard Tables

There are two placard tables, Table 1 and Table 2. Table 1 materials must be placarded whenever any amount is transported (See Figure 9.7).

Placard Table 1 Any Amount	
If Your Vehicle Contains Any Amount Of.....	Placard As...
1.1 Mass Explosives	Explosives 1.1
1.2 Project Hazards	Explosives 1.2
1.3 Mass Fire Hazards	Explosives 1.3
2.3 Poisonous/Toxic Gases	Poison Gas
4.3 Dangerous When Wet	Dangerous When Wet
5.2 (Organic Peroxide, Type B, liquid or solid, Temperature controlled)	Organic Peroxide
6.1 (Inhalation hazard zone A & B only)	Poison/toxic inhalation
7 (Radioactive Yellow III label only)	Radioactive

Figure 9.7

Except for bulk packaging, the hazard classes in Table 2 need placards only if the total amount transported is 1,001 pounds or more including the package. Add the amounts from all shipping papers for all the Table 2 products you have on board (See Figure 9.8).

You may use DANGEROUS placards instead of separate placards for each Table 2 hazard class when:

- You have 1,001 pounds or more of two or more Table 2 hazard classes, requiring different placards, and
- You have not loaded 2,205 pounds or more of any Table 2 hazard class material at any one place. (You must use the specific placard for this material.)
- The dangerous placard is an option, not a requirement. You can always placard for the materials.

Figure 9.8 Placard Table 2 1,001 Pounds Or More	
Category of Material (Hazard class or division number and additional description, as appropriate)	Placard Name
1.4 Minor Explosion	Explosives 1.4
1.5 Very Insensitive	Explosives 1.5
1.6 Extremely Insensitive	Explosives 1.6
2.1 Flammable Gases	Flammable Gas
2.2 Non- Flammable Gases	Non-Flammable Gas
3 Flammable Liquids	Flammable
Combustible Liquid	Combustible*
4.1 Flammable Solids	Flammable Solid
4.2 Spontaneously Combustible	Spontaneously Combustible
5.1 Oxidizers	Oxidizer
5.2 (other than organic peroxide, Type B, liquid or solid, Temperature Controlled)	Organic Peroxide
6.1 (other than inhalation hazard zone A or B)	Poison
6.2 Infectious Substances	(None)
8 Corrosives	Corrosive
9 Miscellaneous Hazardous Materials	Class 9**
ORM-D	(None)
* FLAMMABLE may be used in place of a COMBUSTIBLE on a cargo tank or portable tank.	
** Class 9 Placard is not required for domestic transportation.	

If the words INHALATION HAZARD are on the shipping paper or package, you must display POISON GAS or POISON INHALATION placards in addition to any other placards needed by the product's hazard class. The 1,000 pound exception does not apply to these materials.

Materials with a secondary hazard of dangerous when wet must display the DANGEROUS WHEN WET placard in addition to any other placards needed by the product's hazard class. The 1,000-pound exception to placarding does not apply to these materials.

Placards used to identify the primary or subsidiary hazard class of a material must have the hazard class or division number displayed in the lower corner of the

placard. Permanently affixed subsidiary hazard placards without the hazard class number may be used as long as they stay within color specifications.

Placards may be displayed for hazardous materials even if not required so long as the placard identifies the hazard of the material being transported.

Bulk packaging is a single container with a capacity of 119 gallons or more. A bulk package, and a vehicle transporting a bulk package, must be placarded, even if it only has the residue of a hazardous material. Certain bulk packages only have to be placarded on the two opposite sides or may display labels. All other bulk packages must be placarded on all four sides.

Subsections 9.1, 9.2, and 9.3

Test Your Knowledge

1. Shippers package in order to (fill in the blank) the material.
2. Driver placard their vehicle to (fill in the blank) the risk.
3. What three things do you need to know to decide which placards (if any) you need?
4. A hazardous materials identification number must appear on the (fill in the blank) and on the (fill in the blank). The identification number must also appear on cargo tanks and other bulk packaging.
5. Where must you keep shipping papers describing hazardous materials?

These questions may be on your test. If you can't answer them all, re-read subsections 9.1, 9.2 and 9.3.

9.4 LOADING AND UNLOADING

Do all you can to protect containers of hazardous materials. Don't use any tools which might damage containers or other packaging during loading. Don't use hooks.

9.4.1 General Loading Requirements

Before loading or unloading, set the parking brake. Make sure the vehicle will not move.

Many products become more hazardous when exposed to heat. Load hazardous materials away from heat sources.

Watch for signs of leaking or damaged containers: **LEAKS SPELL TROUBLE!** Do not transport leaking packages. Depending on the material, you, your truck, and others could be in danger. It is illegal to move a vehicle with leaking hazardous materials.

Containers of hazardous materials must be braced to prevent movement of the packages during transportation.

No Smoking: When loading or unloading hazardous materials, keep fire away. Don't let people smoke nearby. Never smoke around-

- Class 1 (Explosives)
- Class 2.1 (Flammable Gas)
- Class 3 (Flammable Liquids)
- Class 4 (Flammable Solids)
- Class 5 (Oxidizers)

Secure Against Movement: Brace containers so they will not fall, slide, or bounce around during transportation. Be very careful when loading containers that have valves or other fittings. All hazardous materials packages must be secured during transportation.

After loading, do not open any package during your trip. Never transfer hazardous materials from one package to another while in transit. You may empty a cargo tank, but do not empty any other package while it is on the vehicle.

Cargo Heater Rules: There are special cargo heater rules for loading-

- Class 1 (Explosives)
- Class 2.1 (Flammable Gas)
- Class 3 (Flammable Liquids)

The rules usually forbid use of cargo heaters, including automatic cargo heater/air conditioner units. Unless you have read all the related rules, don't load the above products in a cargo space that has a heater.

Use Closed Cargo Space: You cannot have overhang or tailgate loads of-

- Class 1 (Explosives)
- Class 4 (Flammable Solids)
- Class 5 (Oxidizers)

You must load these hazardous materials into a closed cargo space unless all packages are:

- Fire and water resistant.
- Covered with a fire and water resistant tarp.

Precautions for Specific Hazards

Class 1 (Explosives) Materials: Turn your engine off before loading or unloading any explosives. Then check the cargo space. You must-

- Disable cargo heaters. Disconnect heater power sources and drain heater fuel tanks.
- Make sure there are no sharp points that might damage cargo. Look for bolts, screws, nails, broken side panels, and broken floorboards.





- Use a floor lining with Division 1.1, 1.2, or 1.3. The floors must be tight and the liner must be either non-metallic material or non-ferrous (no iron) metal.

Use extra care to protect explosives: Never use hooks or other metal tools. Never drop, throw, or roll packages. Protect explosive packages from other cargo that might cause damage.

Do not transfer a Division 1.1, 1.2, or 1.3 from one vehicle to another on a public roadway except in an emergency. If safety requires an emergency transfer, set out red warning reflectors, flags, or electric lanterns. You must warn others on the road.

Never transport damaged packages of explosives. Do not take a package that shows any dampness or oily stain.

Do not transport Division 1.1 or 1.2 in vehicle combinations if:

- There is a marked or placarded cargo tank in the combination.
- The other vehicle in the combination contains:
 -  Division 1.1 A (Initiating Explosives).
 -  Packages of Class 7 (Radioactive) materials labeled "Yellow III."
 -  Division 2.3 (Poisonous Gas) or Division 6.1 (Poisonous) materials.
 -  Hazardous materials in a portable tank, on a DOT Spec 106A or 110A tank.

Class 4 (Flammable Solids) and Class 5 (Oxidizers) Materials: Class 4 materials are solids that react (including fire and explosion) to water, heat, and air or even react spontaneously.

Class 4 and 5 materials must be completely enclosed in a vehicle or covered securely. Class 4 and 5 materials, which become unstable and dangerous when wet, must be kept dry while in transit and during loading and unloading. Materials that are subject to

spontaneous combustion or heating must be in vehicles with sufficient ventilation.

Class 8 (Corrosive) Materials: If loading by hand, load breakable containers of corrosive liquid one by one. Keep them right side up. Do not drop or roll the containers. Load them onto an even floor surface. Stack carboys only if the lower tiers can bear the weight of the upper tiers safely.

Do not load nitric acid above any other product.

Load charged storage batteries so their liquid won't spill. Keep them right side up. Make sure other cargo won't fall against or short circuit them.

Never load corrosive liquids next to or above:

- Division 1.4 (Explosives C).
- Division 4.1 (Flammable Solids).
- Division 4.3 (Dangerous When Wet).
- Class 5 (Oxidizers).
- Division 2.3, Zone B (Poisonous Gases).

Never load corrosive liquids with:

- Division 1.1 or 1.2.
- Division 1.2 or 1.3).
- Division 1.5 (Blasting Agents).
- Division 2.3, Zone A (Poisonous Gases).
- Division 4.2 (Spontaneously Combustible Materials).
- Division 6.1, PGI, Zone A (Poison Liquids).

Class 2 (Compressed Gases) Including Cryogenic Liquids: If your vehicle doesn't have racks to hold cylinders, the cargo space floor must be flat. The cylinders must be:

- Held upright.
- In racks attached to the vehicle or in boxes that will keep them from turning over.
- Cylinders may be loaded in a horizontal position (lying down) if it is designed so the relief valve is in the vapor space.

Division 2.3 (Poisonous Gas) or Division 6.1 (Poisonous) Materials: Never transport these materials in containers with interconnections. Never load a package labeled POISON or POISON INHALATION HAZARD in the driver's cab or sleeper or with food material for human or animal consumption. There are special rules for loading and unloading Class 2 materials in cargo tanks. You must have special training to do this.

Class 7 (Radioactive) Materials: Some packages of Class 7 (Radioactive) materials bear a number called the "transport index." The shipper labels these packages Radioactive II or Radioactive III, and prints the package's transport index on the label. Radiation surrounds each package, passing through all nearby packages. To deal with this problem, the number of packages you can load together is controlled. Their closeness to people, animals, and unexposed film is also controlled. The transport index tells the degree of control needed during transportation. The total transport index of all packages in a single vehicle must not exceed 50. Table A to this section shows rules for each transport index. It shows how close you can load Class 7 (Radioactive) materials to people, animals, or film. For example, you can't leave a package with a transport index of 1.1 within two feet of people or cargo space walls.

Do Not Load Table	
Do Not Load	In The Same Vehicle With
Division 6.1 or 2.3 (POISON or poison inhalation hazard labeled material)	Animal or human food unless the poison package is over packed in an approved way. Foodstuffs are anything you swallow. However, mouthwash, toothpaste, and skin creams are not foodstuff.
<ul style="list-style-type: none"> • Division 2.3 (Poisonous) gas Zone A or • Division 6.1 (Poison) liquids, PGI, Zone A 	<ul style="list-style-type: none"> • Division 1.1, 1.2, 1.3 Explosives • Division 5.1 (Oxidizers) • Class 3 (Flammable Liquids) • Class 8 (Corrosive Liquids) • Division 5.2 (Organic Peroxides) • Division 1.5 (Blasting Agents) • Division 2.1 (Flammable Gases) • Class 4 (Flammable Solids)
Charged storage batteries	Division 1.1
Class 1 (Detonating primers)	Any other explosives unless in authorized containers or packages.
Division 6.1 (Cyanides or cyanide mixtures)	Acids, corrosive materials, or other acidic materials which could release hydrocyanic acid. For Example: Cyanides, Inorganic, n.o.s. Silver Cyanide Sodium Cyanide
Nitric acid (Class 8)	Other materials unless the nitric acid is not loaded above any other material

Figure 9.9

Mixed loads: The rules require some products to be loaded separately. You cannot load them together in the same cargo space. **Figure 9.9** lists some examples. The regulations (the Segregation Table for Hazardous Materials) name other materials you must keep apart.

Subsection 9.4

Test Your Knowledge

1. Around which hazard classes must you never smoke?
2. Which three hazard classes should not be loaded into a trailer that has a heater/air conditioner unit?

3. Should the floor liner required for Division 1.1 or 1.2 materials be stainless steel?
4. At the shipper's dock you're given a paper for 100 cartons of battery acid. You already have 100 pounds of dry Silver Cyanide on board. What precautions do you have to take?
5. Name a hazard class that uses transport indexes to determine the amount that can be loaded in a single vehicle.

These questions may be on your test. If you can't answer them all, re-read subsection 9.4.

9.5 BULK PACKAGING MARKING, LOADING AND UNLOADING

The glossary at the end of this chapter gives the meaning of the word bulk. Cargo tanks are bulk packaging permanently attached to a vehicle. Cargo tanks remain on the vehicle when you load and unload them. Portable tanks are bulk packaging, which are not permanently attached to a vehicle. The product is loaded or unloaded while the portable tanks are off the vehicle. Portable tanks are then put on a vehicle for transportation. There are many types of cargo tanks in use. The most common cargo tanks are MC306 for liquids and MC331 for gases.

9.5.1 Markings

You must display the identification number of the hazardous materials in portable tanks and cargo tanks and other bulk packaging (such as dump trucks). Identification numbers are in column 4 of the Hazardous Materials Table. The rules require black 100 mm (3.9 inch) numbers on orange panels, placards, or a white, diamond-shaped background if no placards are required. Specification cargo tanks must show re-test date markings.

Portable tanks must also show the lessee or owner's name. They must also display the shipping name of the contents on two opposing sides. The letters of the shipping name must be at least two inches tall on portable tanks with capacities of more than 1,000 gallons and one-inch tall on portable tanks with capacities of less than 1,000 gallons. The identification number must appear on each side and each end of a

portable tank or other bulk packaging that hold 1,000 gallons or more and on two opposing sides, if the portable tank holds less than 1,000 gallons. The identification numbers must still be visible when the portable tank is on the motor vehicle. If they are not visible, you must display the identification number on both sides and ends of the motor vehicle.

Intermediate bulk containers (IBCs) are bulk packages, but are not required to have the owner's name or shipping name.

9.5.2 Tank Loading

The person in charge of loading and unloading a cargo tank must be sure a qualified person is always watching. This person watching the loading or unloading must:

- Be alert.
- Have a clear view of the cargo tank.
- Be within 25 feet of the tank.
- Know of the hazards of the materials involved.
- Know the procedures to follow in an emergency.
- Be authorized to move the cargo tank and able to do so.

There are special attendance rules for cargo tanks transporting propane and anhydrous ammonia.

Close all manholes and valves before moving a tank of hazardous materials, no matter how small the amount in the tank or how short the distance. Manholes and valves must be closed to prevent leaks. It is illegal to move a cargo tank with open valves or covers unless it is empty according to 49 CFR 173.29.

9.5.3 Flammable Liquids

Turn off your engine before loading or unloading any flammable liquids. Only run the engine if needed to operate a pump. Ground a cargo tank correctly before filling it through an open filling hole. Ground the tank

before opening the filling hole, and maintain the ground until after closing the filling hole.

9.5.4 Compressed Gas

Keep liquid discharge valves on a compressed gas tank closed except when loading and unloading. Unless your engine runs a pump for product transfer, turn it off when loading or unloading. If you use the engine, turn it off after product transfer, before you unhook the hose. Unhook all loading/unloading connections before coupling, uncoupling, or moving a cargo tank. Always chock trailers and semi-trailers to prevent motion when uncoupled from the power unit.

Subsection 9.5

Test Your Knowledge

1. What are cargo tanks?
2. How is a portable tank different from a cargo tank?
3. Your engine runs a pump used during delivery of compressed gas. Should you turn off the engine before or after unhooking hoses after delivery?

These questions may be on your test. If you can't answer them all, re-read subsection 9.5.

9.6 HAZARDOUS MATERIALS DRIVING AND PARKING RULES

9.6.1 Parking with Division 1.1, 1.2, or 1.3 Explosives

Never park with Division 1.1, 1.2, or 1.3 explosives within five (5) feet of the traveled part of the road except for short periods of time needed for vehicle operation necessities (e.g., fueling). Do not park within 300 feet of:

- A bridge, tunnel, or building.
- A place where people gather.
- An open fire.

If you must park to do your job, do so only briefly.

Don't park on private property unless the owner is aware of the danger. Someone must always watch the parked vehicle. You may let someone else watch it for you only if your vehicle is:

- On the shipper's property.
- On the carrier's property.
- On the consignee's property.

You are allowed to leave your vehicle unattended in a safe haven. A safe haven is an approved place for parking unattended vehicles loaded with explosives. Designation of authorized safe havens is usually made by local authorities.

9.6.2 Parking a Placarded Vehicle (Not Transporting Explosives)

You may park a placarded vehicle (not laden with Division 1.1, 1.2, or 1.3 explosives) within five (5) feet of the traveled part of the road only if your work requires it. Do so only briefly. Someone must always watch the vehicle when parked on a public roadway or shoulder. Do not uncouple a trailer and leave it with hazardous materials on a public street. Do not park within 300 feet of an open fire.

9.6.3 Attending Parked Vehicles

The person attending a placarded vehicle must:

- Be in the vehicle, awake, and not in the sleeper berth, or within 100 feet of the vehicle and have it within clear view.
- Be aware of the hazards of the materials being transported.
- Know what to do in emergencies.
- Be able to move the vehicle, if needed.

9.6.4 No Flares!

You might break down and have to use stopped vehicle signals. Use reflective triangles or red electric lights. Never use burning signals, such as flares or fuses, around a:

- Tank used for Class 3 (Flammable Liquids) or Division 2.1 (Flammable Gas) whether loaded or empty.
- Vehicle loaded with Division 1.1, 1.2, or 1.3 Explosives.

9.6.5 Route Restrictions



Some states and counties require permits to transport hazardous materials or wastes. They may limit the routes you can use. Local rules about routes and permits change often. It is your job as driver to find out if you need permits or must use special routes. Make sure you have all needed papers before starting.

If you work for a carrier, ask your dispatcher about route restrictions or permits. If you are an independent trucker and are planning a new route, check with state agencies where you plan to travel. Some localities prohibit transportation of hazardous materials through tunnels, over bridges, or other roadways. Always check before you start.

Whenever placarded, avoid heavily populated areas, crowds, tunnels, narrow streets, and alleys. Take other routes, even if inconvenient, unless there is no other way. Never drive a placarded vehicle near open fires unless you can safely pass without stopping.

If transporting Division 1.1, 1.2, or 1.3 explosives, you must have a written route plan and follow that plan. Carriers prepare the route plan in advance and give the driver a copy. You may plan the route yourself if you pick up the explosives at a location other than your employer's terminal. Write out the plan in advance. Keep a copy of it with you while transporting the explosives. Deliver shipments of explosives only to authorized persons or leave them in locked rooms designed for explosives storage.

A carrier must choose the safest route to transport placarded radioactive materials. After choosing the route, the carrier must tell the driver about the radioactive materials, and show the route plan.

9.6.6 No Smoking

Do not smoke within 25 feet of a placarded cargo tank used for Class 3 (flammable liquids) or Division 2.1 (gases). Also, do not smoke or carry a lighted cigarette, cigar, or pipe within 25 feet of any vehicle, which contains:

- Class 1 (Explosives)
- Class 3 (Flammable Liquids)
- Class 4 (Flammable Solids)
- Class 4.2 (Spontaneously Combustible)

9.6.7 Refuel with Engine Off

Turn off your engine before fueling a motor vehicle containing hazardous materials. Someone must always be at the nozzle, controlling fuel flow.

9.6.8 10 B:C Fire Extinguisher

The power unit of placarded vehicles must have a fire extinguisher with a UL rating of 10 B:C or more.



9.6.9 Check Tires

Make sure your tires are properly inflated. Check placarded vehicles with dual tires at the start of each trip and when you park. You must check the tires each

time you stop. The only acceptable way to check tire pressure is to use a tire pressure gauge.

Do not drive with a tire that is leaking or flat except to the nearest safe place to fix it. Remove any overheated tire and place it a safe distance from your vehicle. Don't drive until you correct the cause of the overheating. Remember to follow the rules about parking and attending placarded vehicles, because they apply even when checking, repairing, or replacing tires.

9.6.10 Where to Keep Shipping Papers and Emergency Response Information

- Do not accept a hazardous materials shipment without a properly prepared shipping paper. A shipping paper for hazardous materials must always be easily recognized. Other people must be able to find it quickly after a crash.
- Clearly distinguish hazardous materials shipping papers from others by tabbing them or keeping them on top of the stack of papers.
- When you are behind the wheel, keep shipping papers within your reach (with your seat belt on), or in a pouch on the driver's door. They must be easily seen by someone entering the cab.
- When not behind the wheel, leave shipping papers in the driver's door pouch or on the driver's seat.
- Emergency response information must be kept in the same location as the shipping paper.

Papers for Division 1.1, 1.2 or, 1.3 Explosives:

A carrier must give each driver transporting Division 1.1, 1.2, or 1.3 explosives a copy of Federal Motor Carrier Safety Regulations (FMCSR), Part 397. The carrier must also give written instructions on what to do if delayed or in an accident. The written instructions must include:

- The names and telephone numbers of people to contact (including carrier agents or shippers).

- The nature of the explosives transported.
- The precautions to take in emergencies such as fires, accidents, or leaks.

Drivers must sign a receipt for these documents.

You must be familiar with, and have in your possession while driving, the:

- Shipping papers.
- Written emergency instructions.
- Written route plan.
- A copy of FMCSR, Part 397.

9.6.11 Equipment for Chlorine

A driver transporting chlorine in cargo tanks must have an approved gas mask in the vehicle. The driver must also have an emergency kit for controlling leaks in dome cover plate fittings on the cargo tank.

9.6.12 Stop Before Railroad Crossings

Stop before a railroad crossing if your vehicle:

- Is placarded.
- Carries any amount of chlorine.
- Has cargo tanks, whether loaded or empty used for hazardous materials.

You must stop 15 to 50 feet before the nearest rail. Proceed only when you are sure no train is coming and you can clear the tracks without stopping. Don't shift gears while crossing the tracks.

9.7 HAZARDOUS MATERIALS-EMERGENCIES

9.7.1 Emergency Response Guidebook (ERG)

The Department of Transportation has a guidebook for firefighters, police, and industry workers on how to protect themselves and the public from hazardous materials. The guide is indexed by proper shipping name and hazardous materials identification number. Emergency personnel look for these things on the shipping paper. That is why it is vital that the proper shipping name, identification number, label, and placards are correct.

9.7.2 Crashes/Incidents

As a professional driver, your job at the scene of a crash or an incident is to:

- Keep people away from the scene.
- Limit the spread of material, only if you can safely do so.
- Communicate the danger of the hazardous materials to emergency response personnel.
- Provide emergency responders with the shipping papers and emergency response information.

Follow this checklist:

- Check to see that your driving partner is OK.
- Keep shipping papers with you.
- Keep people far away and upwind.
- Warn others of the danger.
- Call for help.
- Follow your employer's instructions.

9.7.3 Fires

You might have to control minor truck fires on the road. However, unless you have the training and equipment to do so safely, don't fight hazardous materials fires. Dealing with hazardous materials fires requires special training and protective gear.

When you discover a fire, call for help. You may use the fire extinguisher to keep minor truck fires from spreading to cargo before firefighters arrive. Feel trailer doors to see if they are hot before opening them. If hot, you may have a cargo fire and should not open the doors. Opening doors lets air in and may make the fire flare up. Without air, many fires only smolder until firemen arrive, doing less damage. If your cargo is already on fire, it is not safe to fight the fire. Keep the shipping papers with you to give to emergency personnel as soon as they arrive. Warn other people of the danger and keep them away.

If you discover a cargo leak, identify the hazardous materials leaking by using shipping papers, labels, or package location. Do not touch any leaking material--many people injure themselves by touching hazardous materials. Do not try to identify the material or find the source of a leak by smell. Toxic gases can destroy your sense of smell and can injure or kill you even if they don't smell. Never eat, drink, or smoke around a leak or spill.

If hazardous materials are spilling from your vehicle, do not move it any more than safety requires. You may move off the road and away from places where people gather, if doing so serves safety. Avoid stopping near roadside rest areas, truck stops, cafes, and businesses. Do not move your vehicle, if doing so will cause contamination or damage the vehicle. Only move your vehicle if you can do so without danger to yourself or others. Keep upwind from the vehicle once stopped.

Never continue driving with hazardous materials leaking from your vehicle in order to find a phone booth, truck stop, help, or similar reason. Remember, the carrier pays for the cleanup of contaminated parking lots, roadways, and drainage ditches. The costs are enormous, so don't leave a lengthy trail of contamination.

If hazardous materials are spilling from your vehicle:

- Park it.
- Secure the area.
- Stay there.
- Send someone else for help.
- When sending someone for help, give that person:
 - A description of the emergency.
 - Your exact location and direction of travel.
 - Your name, the carrier's name, and the name of the community or city where your terminal is located.
 - The proper shipping name, hazard class, and identification number of the hazardous materials, if you know them.

This is a lot for someone to remember. It is a good idea to write it all down for the person you send for help. The emergency response team must know these things to find you and to handle the emergency. They may have to travel miles to get to you. This information will help them to bring the right equipment the first time, without having to go back for it.

Never try to repack leaking containers. Unless you have the training and equipment to repair leaks safely, don't try it. Call your dispatcher or supervisor for instructions and, if needed, emergency personnel.

9.7.4 Responses to Specific Hazards



Class 1 (Explosives) If your vehicle has a breakdown or accident while carrying explosives, warn others of the danger. Keep bystanders away. Do not allow smoking or open fire near the vehicle. If there is a fire, warn everyone of the danger of explosion.

Class 1 (Explosives), continued:

Remove all explosives before separating vehicles involved in a collision. Place the explosives at least 200 feet from the vehicles and occupied buildings. Stay a safe distance away.

Class 2 (Compressed Gases)

If compressed gas is leaking from your vehicle, warn others of the danger. Only permit those involved in removing the hazard or wreckage to get close. You must notify the shipper if compressed gas is involved in any accident.



Unless you are fueling machinery used in road construction or maintenance, do not transfer a flammable compressed gas from one tank to another on any public roadway.



Class 3 (Flammable Liquids): If you are transporting a flammable liquid and have an accident or your vehicle breaks down, prevent bystanders from gathering. Warn people of the danger. Keep them from smoking.

Never transport a leaking cargo tank farther than needed to reach a safe place. Get off the roadway if you can do so safely. Don't transfer flammable liquid from one vehicle to another on a public roadway except in an emergency.



Class 4 (Flammable Solids) and Class 5 (Oxidizing Materials): If a flammable solid or oxidizing material spills, warn others of the fire hazard. Do not open



smoldering packages of flammable solids. Remove them from the vehicle if you can safely do so. Also, remove unbroken packages if it will decrease the fire hazard.



Class 6 (Poisonous Materials and Infectious Substances): It is your job to protect yourself, other people, and property from harm. Remember that many products classed as poison are also flammable. If you think a Division

2.3 (Poison Gases) or Division 6.1 (Poison Materials) might be flammable, take the added precautions needed for flammable liquids or gases. Do not allow smoking, open flame, or welding. Warn others of the hazards of fire, of inhaling vapors, or coming in contact with the poison.

A vehicle involved in a leak of Division 2.3 (Poison Gases) or Division 6.1 (Poisons) must be checked for stray poison before being used again.

If a Division 6.2 (Infectious Substances) package is damaged in handling or transportation, you should immediately contact your supervisor. Packages that appear to be damaged or show signs of leakage should not be accepted.



Class 7 (Radioactive Materials): If radioactive material is involved in a leak or broken package, tell your dispatcher or supervisor as soon as possible. If there is a spill, or if an internal container might be damaged, do

not touch or inhale the material. Do not use the vehicle until it is cleaned and checked with a survey meter.



Class 8 (Corrosive Materials): If corrosives spill or leak during transportation, be careful to avoid further damage or injury when handling the containers. Parts of the vehicle exposed to a corrosive liquid must be

thoroughly washed with water. After unloading, wash out the interior as soon as possible before reloading.

If continuing to transport a leaking tank would be unsafe, get off the road. If safe to do so, contain any liquid leaking from the vehicle. Keep bystanders away from the liquid and its fumes. Do everything possible to prevent injury to yourself and to others.

9.7.5 Required Notification

The National Response Center helps coordinate emergency response to chemical hazards. It is a resource to the police and firefighters. It maintains a 24-hour toll-free line listed below. You or your employer must phone when any of the following occur as a direct result of a hazardous materials incident:

- A person is killed.
- An injured person requires hospitalization.
- Estimated property damage exceeds \$50,000.
- The general public is evacuated for more than one hour.
- One or more major transportation arteries or facilities are closed for one hour or more.
- Fire, breakage, spillage, or suspected radioactive contamination occurs.
- Fire, breakage, spillage or suspected contamination occur involving shipment of etiologic agents (bacteria or toxins).
- A situation exists of such a nature (e.g., continuing danger to life exists at the scene of an incident) that, in the judgment of the carrier, should be reported.

National Response Center (800) 424-8802

Persons telephoning the National Response Center should be ready to give:

- Their name.
- Name and address of the carrier they work for.
- Phone number where they can be reached.
- Date, time, and location of incident.
- The extent of injuries, if any.

- Classification, name, and quantity of hazardous materials involved, if such information is available.
- Type of incident and nature of hazardous materials involvement and whether a continuing danger to life exists at the scene.

If a reportable quantity of hazardous substance was involved, the caller should give the name of the shipper and the quantity of the hazardous substance discharged.

Be prepared to give your employer the required information as well. Carriers must make detailed written reports within 30 days of an incident.

**CHEMTREC
(800) 424-9300**

The Chemical Transportation Emergency Center (CHEMTREC) in Washington also has a 24-hour toll-free line. CHEMTREC was created to provide emergency personnel with technical information about the physical properties of hazardous materials. The National Response Center and CHEMTREC are in close communication. If you call either one, they will tell the other about the problem when appropriate.

Radioactive Separation Table A						
TOTAL TRANSPORT INDEX	Minimum Distance In Feet To Nearest Undeveloped Film					TO PEOPLE OR CARGO COMPART- MENT PARTITIONS
	0 - 2 Hrs	2 - 4 Hrs	4 - 8 Hrs	8 - 12 Hrs	Over 12 hrs	
None	0	0	0	0	0	0
0.1 to 1.0	1	2	3	4	5	1
1.1 to 5.0	3	4	6	8	11	2
5.1 to 10.0	4	6	9	11	15	3
10.1 to 20.0	5	8	12	16	22	4
20.1 to 30.0	7	10	15	20	29	5
30.1 to 40.0	8	11	17	22	33	6
40.1 to 50.0	9	12	19	24	36	-

Figure 9.10

Do not leave radioactive yellow - II or yellow - III labeled packages near people, animals, or film longer than shown in **Figure 9.10**

Classes of Hazardous Materials

Hazardous materials are categorized into nine major hazard classes and additional categories for consumer commodities and combustible liquids. The classes of hazardous materials are listed in **Figure 9.11**.

Figure 9.11 Hazard Class Definitions Table B		
Class	Class Name	Example
1	Explosives	Ammunition, Dynamite, Fireworks
2	Gases	Propane, Oxygen, Helium
3	Flammable	Gasoline Fuel, Acetone
4	Flammable Solids	Matches, Fuses
5	Oxidizers	Ammonium Nitrate, Hydrogen Peroxide
6	Poisons	Pesticides, Arsenic
7	Radioactive	Uranium, Plutonium
8	Corrosives	Hydrochloric Acid, Battery Acid
9	Miscellaneous Hazardous Materials	Formaldehyde, Asbestos
None	ORM-D (Other Regulated Material-Domestic)	Aerosol Cans Charcoal Auto Batteries
None	Combustible Liquids	Fuel Oils, Lighter Fluid

Subsections 9.6 and 9.7

Test Your Knowledge

1. If your placarded trailer has dual tires, how often should you check the tires?
2. What is a safe haven?
3. How close to the traveled part of the roadway can you park with Division 1.2 or 1.3 materials?

4. How close can you park to a bridge, tunnel, or building with the same load?
5. What type of fire extinguisher must placarded vehicles carry?
6. You're hauling 100 pounds of Division 4.3 (dangerous when wet) materials. Do you need to stop before a railroad-highway crossing?
7. At a rest area you discover your hazardous materials shipments slowly leaking from the vehicle. There is no phone around. What should you do?
8. What is the Emergency Response Guide (ERG)?

These questions may be on your test. If you can't answer them all, re-read subsections 9.6 and 9.7.

9.8 HAZARDOUS MATERIALS GLOSSARY

This glossary presents definitions of certain terms used in this section. A complete glossary of terms can be found in the federal Hazardous Materials Rules (49 CFR 171.8). You should have an up-to-date copy of these rules for your reference.

(Note: You will not be tested on this glossary)

Sec. 171.8 Definitions and abbreviations.

Bulk packaging: Packaging, other than a vessel, or a barge, including a transport vehicle or freight container, in which hazardous materials are loaded with no intermediate form of containment and which has:

1. A maximum capacity greater than 450 L (119 gallons) as a receptacle for a liquid;
2. A maximum net mass greater than 400 kg (882 pounds) or a maximum capacity greater than 450 L (119 gallons) as a receptacle for a solid; or
3. A water capacity greater than 454 kg (1000 pounds) as a receptacle for a gas as defined in Sec. 173.115.

Cargo tank: A bulk packaging which-

1. Is a tank intended primarily for the carriage of liquids or gases and includes appurtenances, reinforcements, fittings, and closures (for "tank", see 49 CFR 178.345-1(c), 178.337-1, or 178.338-1, as applicable);
2. Is permanently attached to or forms a part of a motor vehicle, or is not permanently attached to a motor vehicle but which, by reason of its size, construction, or attachment to a motor vehicle is loaded or unloaded without being removed from the motor vehicle; and
3. Is not fabricated under a specification for cylinders, portable tanks, tank cars, or multi-unit tank car tanks.

Carrier: A person engaged in the transportation of passengers or property by-

1. Land or water as a common, contract, or private carrier, or
2. Civil aircraft.

Consignee: The business or person to whom a shipment is delivered.

Division: A subdivision of a hazard class.

EPA: U.S. Environmental Protection Agency.

FMCSR: The Federal Motor Carrier Safety Regulations.

Freight container: A reusable container having a volume of 64 cubic feet or more, designed and constructed to permit being lifted with its contents intact and intended primarily for containment of packages (in unit form) during transportation.

Fuel tank: A tank, other than a cargo tank, used to transport flammable or combustible liquid or compressed gas for the purpose of supplying fuel for propulsion of the transport vehicle to which it is attached, or for the operation of other equipment on the transport vehicle.

Gross weight or gross mass: The weight of the packaging plus the weight of its contents.

Hazard class: The category of hazard assigned to a hazardous material under the definitional criteria of Part 173 and the provisions of the Sec. 172.101 Table. A material may meet the defining criteria for more than one hazard class but is assigned to only one hazard class.

Hazardous materials: A substance or material which has been determined by the Secretary of Transportation to be capable of posing an unreasonable risk to health, safety, and property when transported in commerce, and which has been so designated. The term includes hazardous substances, hazardous wastes, marine pollutants, elevated temperature materials and materials designated as hazardous in the hazardous materials table of §172.101, and materials that meet the defining criteria for hazard classes and divisions in §173, subchapter (c) of this chapter.

Hazardous substance: A material, including its mixtures and solutions, that:

1. Is listed in Appendix A to Sec. 172.101;
2. Is in a quantity, in one package, which equals or exceeds the reportable quantity (RQ) listed in Appendix A to Sec. 172.101; and
3. When in a mixture or solution:
 - (i) For radionuclides, conforms to paragraph 7 of Appendix A to Sec. 172.101.
 - (ii) For other than radionuclides, is in a concentration by weight which equals or exceeds the concentration corresponding to the RQ of the material, as shown in **Figure 9.12**.

Figure 9.12			
Hazardous Substance Concentrations			
RQ Pounds (Kilograms)		Concentration by Weight	
		Percent	PPM
5,000	(2,270)	10	100,000
1,000	(454)	2	20,000
100	(45.4)	.2	2,000
10	(4.54)	.02	200
1	(0.454)	.002	20

This definition does not apply to petroleum products that are lubricants or fuels (see 40 CFR 300.6).

Hazardous waste: For the purposes of this chapter, means any material that is subject to the Hazardous Waste Manifest Requirements of the U.S. Environmental Protection Agency specified in 40 CFR Part 262.

Intermediate bulk container (IBC): A rigid or flexible portable packaging, other than a cylinder or portable tank, which is designed for mechanical handling. Standards for IBCs manufactured in the United States are set forth in subparts N and O §178.

Limited quantity: The maximum amount of a hazardous material for which there may be specific labeling or packaging exception.

Marking: The descriptive name, identification number, instructions, cautions, weight, specification, or UN marks or combinations thereof, required by this subchapter on outer packaging of hazardous materials.

Mixture: A material composed of more than one chemical compound or element.

Name of contents: The proper shipping name as specified in Sec. 172.101.

Non-bulk packaging: A packaging, which has:

1. A maximum capacity of 450 L (119 gallons) as a receptacle for a liquid;
2. A maximum net mass less than 400 kg (882 pounds) and a maximum capacity of 450 L (119 gallons) or less as a receptacle for a solid; or
3. A water capacity greater than 454 kg (1,000 pounds) or less as a receptacle for a gas as defined in Sec. 173.115.

N.O.S: Not otherwise specified.

Outage or Ullage: The amount by which a packaging falls short of being liquid full, usually expressed in percent by volume.

Portable tank: Bulk packaging (except a cylinder having a water capacity of 1,000 pounds or less) designed primarily to be loaded onto, or on, or temporarily attached to a transport vehicle or ship and equipped with skids, mountings, or accessories to facilitate handling of the tank by mechanical means. It does not include a cargo tank, tank car, multi-unit tank car tank, or trailer carrying 3AX, 3AAX, or 3T cylinders.

Proper shipping name: The name of the hazardous materials shown in Roman print (not italics) in Sec. 172.101.

P.s.i. or psi: Pounds per square inch.

P.s.i.a. or psia : Pounds per square inch absolute.

Reportable quantity (RQ): The quantity specified in Column 2 of the Appendix to Sec. 172.101 for any material identified in Column 1 of the Appendix.

RSPA now PHMSA: The Pipeline and Hazardous Materials Safety Administration, U.S. Department of Transportation, Washington, DC 20590.

Shipper's certification: A statement on a shipping paper, signed by the shipper, saying he/she prepared the shipment properly according to law. For example:

 "This is to certify that the above named materials are properly classified, described, packaged, marked and labeled, and are in proper condition for transportation according to the applicable regulations or the Department of Transportation." – Or --

 "I hereby declare that the contents of this consignment are fully and accurately described above by the proper shipping name and are classified, packaged, marked and labeled/placarded, and are in all respects in proper condition for transport by * according to applicable international and national government regulations."

 words may be inserted here to indicate mode of transportation (rail, aircraft, motor vehicle, vessel)

Shipping paper: A shipping order, bill of lading, manifest, or other shipping document serving a similar purpose and containing the information required by Sec. 172.202, 172.203, and 172.204.

Technical name: A recognized chemical name or microbiological name currently used in scientific and technical handbooks, journals, and texts.

Transport vehicle: A cargo carrying vehicle such as an automobile, van, tractor, truck, semi-trailer, tank car, or rail car used for the transportation of cargo by any mode. Each cargo carrying body (trailer, rail car, etc.) is a separate transport vehicle.

UN Standard Packaging: A specification packaging conforming to the standards in the UN recommendations.

UN: United Nations.

9.9 HAZARDOUS MATERIALS ENDORSEMENT APPLICATION PROCESS

The information in this section is for informational purposes only. You will not be tested on this subject matter; however, you will find the information contained in this section helpful if you intend to obtain a HAZMAT (H) endorsement.

Application Process:

Step 1: Completing the Application

You can complete the TSA HAZPRINT driver application at:

 <https://hazprints.tsa.dhs.gov> or,

 By calling the TSA Agent Driver Service Center at **1-877-HAZPRINT (1-877-429-7746)**.

The operator at the Driver Service Center will guide you through the process and ensure the application is completed correctly. You can also call the TSA Agent Driver Service Center at any time if you have questions about the website.

NOTE: You must have the application completed prior to arriving at the fingerprint capture location.

At the time you complete the application, you will have to pay a processing fee. That fee is currently \$86.50 (as of the publication of this manual; subject to change without notice). You can pay by credit card directly on the website or by providing the information to the operator at the TSA Agent Driver Service Center. Electronic payments are the most secure and convenient for you, and will save time at the fingerprint collection site. If you choose not to pay electronically, you must bring a money order for the processing fee to the collection site. Cash and personal checks will not be accepted by TSA agents.

Step 2: Getting Fingerprinted- You can find fingerprint locations online at <https://hazprints.tsa.dhs.gov> or call the toll-free number at 1-877 429-7746. HAZPRINT is the best source of information on current site locations, operating hours and driving directions. **You can be fingerprinted at any site location in any participating state.** You will be required to provide two (2) forms of identification prior to being fingerprinted, one of which must be a current Idaho Driver's License. In addition to being fingerprinted, you will be required to review the application you previously submitted, make corrections if necessary and electronically sign the application to verify its accuracy.

Step 3: Security Threat Assessment- Based on the data provided on your HAZPRINT application, the Transportation Security Administration (TSA) will perform a threat assessment. TSA will check the FBI fingerprint data base for criminal history records, intelligence-related checks, and immigration status records. The results of the assessment will be provided directly to the Idaho Transportation Department (ITD), who will update your driver records accordingly. You will also receive a letter regarding the results of their assessment directly from TSA.

Step 4: Status- You should receive the results from TSA approximately three (3) weeks after being fingerprinted; however, it may take longer. The following are the determinations the TSA can make following their assessment:

1. **If the TSA determines you do not pose a security threat:** TSA will issue a **"Determination of No Security Threat"** and notify you that you are clear to be issued a

hazmat endorsement. You can proceed to the county drivers licensing office to take the written examination and be issued a CDL with the hazardous materials endorsement.

2. **If the TSA determines you pose a security threat:** The TSA will notify you directly with the initial determination and provide you with an appeal process.
3. **If you do not appeal:** The TSA will issue a **"Final Determination of Threat Assessment"** to you. The **"Final Determination of Threat Assessment"** cannot be appealed; however, you can still apply to TSA for a waiver.
4. **Request for waivers or appeals:** The request for waivers or appeals may be sent to:

Transportation Security Administration Headquarters
Hazmat Waiver/Appeal Process
Office of Security, 5th floor
701 South 12th St.
Arlington, VA 22202

Step 5: Knowledge Testing- First time, renewal and transfer applicants must pass the written Hazardous Materials knowledge test and receive clearance from the TSA prior to receiving the HAZMAT endorsement on their CDL. The recommendation is to take the written test prior to completing the security assessment. If you take the written test before the assessment is completed, your driver's record will show the test as being completed, but the HAZMAT endorsement will remain in a "Pending" status until the security clearance is received by the State of Idaho. If you choose to wait to take the written test until the security clearance is received by the state, you can take the test and receive your new CDL with the H endorsement at the same time. If you fail the hazmat knowledge test, you must wait three days before retesting.

Renewals and Extensions:

Your TSA security clearance is good for a maximum of five (5) years; however, the State of Idaho requires you to have a security assessment and pass a written examination to renew your hazardous material endorsement every four (4) years. If you have

completed a security threat assessment before, and you are transferring your hazardous materials endorsement to Idaho, you may not have to go through a new threat assessment for the transfer if your Idaho license will expire within less than five (5) years of your last threat assessment.

Issuance or Denial of Hazardous Materials Endorsements:

- If the TSA has issued a **“Determination of No Security Threat”** or has granted a waiver, the department will allow issuance, renewal, or transfer of the hazardous materials endorsement. The applicant should return to the county driver licensing office for issuance of the CDL with a hazardous materials endorsement.
- If the TSA has issued a **“Final Determination of Threat Assessment,”** the department will deny issuance, renewal, or transfer of the hazardous materials endorsement.

Tips for Properly Completing the Application:

- **Specify country of birth:** You can expect significant delays in processing your application if you fail to provide TSA with your country of birth.
- **List Alien Registration Number:** If you have ever been issued an Alien Registration Number, you must list it in the appropriate box on the application form. You must list the Alien Registration Number even if you are a naturalized citizen. A missing or wrongly listed Alien Registration Number will significantly delay processing your application.
- **Do not list Naturalization Number:** If referencing naturalization documents, the Alien Registration Number is generally listed below the Naturalization Number.
- Alien Registration Number should be nine (9) digits long with no alphabetical characters. When referencing naturalization documents, the Alien Registration Number can be found

below the Naturalization Number, unless the document was issued before 1986. Documents issued before that date do not have Alien Registration Numbers.

- **Number Formatting:** All numbers (e.g., height, weight, CDL, phone numbers, SSN) should not have dashes, spaces, hyphens, apostrophes, parentheses or any other characters other than numerals. For example, height and weight are each three (3) digits (e.g., 5 feet 4 inches is entered as 504, not 5’4”, 5-04, etc.). SSN and CDL numbers must not contain dashes, slashes or spaces.
- **Telephone Numbers:** should be ten (10) digits only. Do not include hyphens, parenthesis, the prefix one (1) for long distance, etc.
- **Address:** You must fully complete your home address, including zip code. If the mailing address is not different, than your home address, leave the field blank. Do not put “same,” “see above” or “n/a.” If your mailing address is different from your home address, you must be sure to list it in the appropriate section, including the zip code.
- If any field in the application does not apply to you, **do not put zeroes, “N/A”, “none” or anything else** in them. Leave the fields blank if they are not applicable to you.
- Read the questions thoroughly, because many people don’t and confuse word meanings, like “County” verses “Country.”
- All date fields that are applicable to you require a valid day, month and year. Do not use a partial date like month and year or only the year. If the date fields are not applicable to you, leave them blank.
- Employer name fields are a maximum of 40 characters long. If your employer’s name is longer than 40 characters, abbreviate the name.
- **Military Service:** If you were in the military and don’t know the exact date of your discharge,

you should provide your best estimate. Ensure you use the full date (day, month and year) when completing this information or the application will show an error and will have to be resubmitted.

- If you are still in the military at the time you apply, you should mark the military as your current employer and provide a future discharge date.

Issues that Affect Adjudication Processing Time:

One of the greatest causes of delays in processing an application is due to immigration issues. Most of these issues can be avoided by proper reporting of the Alien Registration Number.

- If you have an Alien Registration Number, and it is not reported or recorded accurately on the application, your final disposition will be substantially delayed.
- An Alien Registration Number is not the same as a Naturalization Number. The Alien Registration Number is typically nine (9) digits long and preceded by an "A." Naturalization Numbers, on the other hand, are only eight (8) digits long. If you have a document with a Naturalization Number, your Alien Registration Number can be found directly below it.
- Do not use your Naturalization Number on the application. You must use your Alien Registration Number without the alphabetical prefix (e.g., Alien Registration Number A123456789 would be listed as 123456789).
- Alien Registration Numbers issued years ago contained eight (8) digits instead of nine (9). If you have an older number with eight (8) digits, add a zero to the beginning of the number when completing the information in the application field (e.g., A12345678 would be listed as 012345678).

Eligibility:

Citizenship or Immigration Status Requirements:

- You must be a citizen of the United States and not have renounced your U.S. citizenship;
- You must be a lawful permanent resident of the U.S. as defined in section 101 (a) (20) of the Immigration and Nationality Act (8 U.S.C. 1101);
- You must be a lawful nonimmigrant and in possession of a valid, unrestricted employment authorization;
- You must be a refugee admitted under section 8 U.S.C. 1157 and in possession of a valid unrestricted employment authorization, or
- You must be in asylum status under section 8 U.S.C. 1158 and in possession of a valid unrestricted employment authorization.

Examples of Acceptable Citizenship or Immigration Status Documents:

- United States Passport;
- Birth Certificate that bears an official seal and was issued by a state, county, municipal authority, or outlying possession of the United States;
- Certification of Birth Abroad issued by the U.S. Department of State (Form FS-545 or DS 1350);
- Certificate of Naturalization (Form N-550 or N-570);
- Certificate of U.S. Citizenship (Form N-560 or N-561);
- Permanent Resident Card, Alien Registration Receipt Card (Form I-551);
- Temporary I-551 stamp on foreign passport;

- Temporary I-551 stamp on Form I-94, Arrival/Departure Record with your photograph, or
- Reentry Permit (Form I-327).

Certification and/or Disclosure of the Following Are Required:

- The applicant has not been convicted or found not guilty by reason of insanity of any of the interim disqualifying crimes in any jurisdiction, civilian or military, during the seven (7) years before the date of application;
- The applicant has not been released from incarceration in any jurisdiction, civilian or military, for committing any interim disqualifying crime during the five (5) years before the date of application;
- The applicant has not been convicted or found not guilty by reason of insanity of any permanently disqualifying crime;
- The applicant is not wanted or under indictment in any jurisdiction, civilian or military, for a disqualifying crime;
- The applicant has not been adjudicated as lacking mental capacity or committed to a mental institution involuntarily;
- The applicant is either a United States citizen who has not renounced United States citizenship, or a lawful permanent resident of the United States, or meets eligibility requirements for immigration status, or
- Disclosure of the applicant's military service and date of discharge.

DISQUALIFYING CRIMES

Permanently Disqualifying Criminal Offenses: You are permanently disqualified from holding a hazardous materials endorsement on your CDL if you were convicted (convicted means any plea of guilty or nolo contendere or any finding of guilt) or found not guilty

by reason of insanity in a civilian or military jurisdiction of any of the following crimes:

- Espionage
- Sedition
- Treason
- A crime listed in 18 U.S.C. Chapter 113B – Terrorism, or a State law that is comparable
- Making any threat, or maliciously conveying false information knowing the same to be false, concerning the deliverance, placement, or detonating of an explosive or other lethal device in or against a place of public use, a state or government facility, a public transportation system, or an infrastructure facility;
- A crime involving a transportation security incident (i.e. security incident involving a significant loss of life, environmental damage, transportation system disruption, or economic disruption in a particular area);
- Improper transportation of a hazardous material under 49 U.C. 5124 or a State law that is comparable (minor infractions involving transportation of hazardous materials will not disqualify a driver. For instance, no driver will be disqualified for minor roadside infractions or placarding violations);
- Unlawful possession, use, sale, distribution, manufacture, purchase, receipt, transfer, shipping, transporting, import, export, storage of, or dealing in an explosive or explosive device;
- Murder as defined in 18 U.S.C. 1111;
- Violations of the Racketeer Influenced and Corrupt Organizations Act, 18 U.S.C. 1961, et seq., or a State law that is comparable, where one of the predicated acts found by a jury or admitted by the defendant, consist of one of the offenses listed in 4 or 8 of this section, or

- Conspiracy or attempt to commit any of the crimes listed above.

Interim Disqualifying Criminal Offenses: You have an interim disqualifying offense if you were convicted (convicted means any plea of guilty or nolo contendere or any finding of guilt) or found not guilty by reason of insanity in a civilian or military jurisdiction, of any of the crimes listed below, if the crime was considered to be a felony in the appropriate jurisdiction, civilian or military within the seven (7) years preceding the date of application; or if you were released from incarceration for the crime within the five (5) years preceding the application date:

- Unlawful entry into a seaport as described in 18 U.S.C. 1036, or a comparable State law;
- Assault with intent to murder;
- Kidnapping or hostage taking;
- Rape or aggravated sexual abuse;
- Unlawful possession, use, sale, manufacture, purchase, distribution, receipt, transfer, shipping, transporting, delivery, import, export of, or dealing in a firearm or other weapon;
- Extortion;
- Dishonesty, fraud, or misrepresentation, including identity fraud;
- Bribery;
- Smuggling;
- Immigration violations;
- Violations of the Racketeer Influenced and Corrupt Organizations Act (RICO), 18 U.S.C. 1961, et seq., or a violation of a comparable State law;
- Robbery;
- Distribution of, possession with intent to distribute, or importation of a controlled substance (State laws vary on the quantity of

marijuana required for the offense to be considered a felony. Typically, however, to be convicted of felony marijuana possession, a person must possess a quantity of marijuana greater than an amount considered for “personal use”);

- Arson, or
- Conspiracy or attempt to commit the crimes in this section.

UNDER WANT OR WARRANT:

You will be disqualified from holding a hazmat endorsement on a CDL if you are wanted or under indictment in any civilian or military jurisdiction for an interim disqualifying or permanently disqualifying felony listed above until the Want or Warrant is released.

APPEALS AND WAIVERS:

You must send appeal or waiver materials to the address listed in your initial Determination of Threat Assessment (IDTA) letter.

QUESTIONS AND ANSWERS:

Q: What is the rule under which TSA is conducting the Hazmat Driver Threat Assessment Program?

A: On May 5, 2003, TSA published a rule to secure the transportation of hazardous materials (Hazmat), including explosives, by requiring threat assessments for all individuals who apply for, renew, or transfer a Hazardous Materials Endorsement (HME) on their Commercial Driver’s License (CDL). On January 25, 2007, TSA modified this rule to include additional disqualifiers and appeal mechanisms.

Q: Who is affected by the rule?

A: You must undergo a threat assessment if you wish to transport hazardous materials requiring vehicle placards under DOT regulations. This rule does not apply to applicants for, or holders

of a CDL, who do not wish to transport hazardous materials.

Q: Does this rule apply to drivers entering the U.S. from Canada and Mexico?

A: This rule applies only to drivers who hold a CDL issued by a state of the U.S. Generally, this would not include drivers from Canada and Mexico. There is a separate rulemaking that addresses Canadian drivers hauling explosives into the U.S. Eventually, all drivers will have to meet the threat assessment and eligibility standards that are comparable to the standards that now apply to Hazmat drivers in the U.S.

Q: What constitutes a “hazardous material” under the rule?

A: Any material that requires placarding under the DOT hazardous materials regulations is considered a hazardous material for purposes of this rule.

Q: Who is eligible to hold and HME under the rule?

A: You must be a U.S. citizen, lawful permanent resident or alien with legal rights to work, and must not pose a threat of terrorism or a threat to national or transportation security.

Q: Will a conviction for drug possession or use disqualify me from holding a Hazmat endorsement?

A: Only if you were convicted of a felony within the past seven (7) years, or were released from prison within the past five (5) years. State laws vary on the quantity of drugs required for the offense to be considered a felony. Misdemeanor drug offenses will not disqualify you from holding a Hazmat endorsement under the rule.

Q: Will a conviction for a minor placarding violation or roadside infraction involving the transport of hazardous materials disqualify me from holding a Hazmat endorsement?

A: No. Under the rule, you will be disqualified from holding and HME if you were convicted or found not guilty by reason of insanity of a felony involving improper transportation of a hazardous material.

Q: What happens to drivers who currently hold Hazmat endorsements, but who are disqualified under this rule?

A: You must voluntarily and immediately surrender your Hazmat endorsement if the standards are not met. You may apply for a waiver if you were convicted or found not guilty by reason of insanity of a disqualifying criminal offense, or were adjudicated as mentally incompetent or involuntarily committed to a mental institution, but you may only apply for the waiver after submitting an application and fingerprints for the threat assessment.

Q: What happens when a threat assessment indicates that a driver does not meet standards set forth under the rule?

A: TSA notifies you of the initial finding that a disqualifying event or status exists and you are given the opportunity to respond. If TSA makes a final determination that you pose a security threat, it will direct the state to revoke your HME. If TSA discovers that you have outstanding criminal or immigration violations or warrants, the information will be transmitted to the proper authorities.

Q: Is there an appeal process for drivers who are disqualified?

A: You may appeal the disqualification on the grounds of mistaken identity or other information, such as a reversed conviction.

Q: Will TSA tell a candidate why he or she is disqualified?

A: Yes, unless the information is classified.

Q: How often must a driver be fingerprinted and qualified under this rule?

A: Generally, you must renew your HME every five (5) years, although some states may require more frequent reviews. Idaho does require you to have another threat assessment done every time you renew your license, which is every four (4) years; therefore, you will be required to submit new fingerprints at that time to renew your endorsement.

Q: Why must individual truckers and/or their employers pay for the security threat assessment?

A: Congress did not appropriate funds to cover the cost of the security threat assessment, and so TSA must charge a fee to recover those costs. Currently, state motor vehicle departments require you to bear all the costs of applying for an HME on a CDL.







Q: Who is not covered by this rule?

A: You are unaffected by this rule if you don't wish to hold an HME. Similarly, you will not be asked to undergo fingerprinting if you wish to surrender your HME. You will not lose your right to hold a CDL or to transport non-hazardous cargo if you were disqualified from carrying hazardous materials due to past criminal convictions.



Chapter 10 : School Buses

This Chapter Covers:

-  **Danger Zones and Use of Mirrors**
-  **Loading and Unloading**
-  **Emergency Exit and Evacuation**
-  **Railroad-highway Grade Crossings**
-  **Student Management**
-  **Antilock Braking Systems**
-  **Special Safety Considerations**

School bus drivers must have a commercial driver's license (CDL) with a passenger endorsement and a school bus endorsement if they drive a school bus designed to transport (seat) 16 or more persons, including the driver.

To get a school bus endorsement, you must pass a knowledge test on this chapter of the manual as well as a written test for a passenger endorsement (refer to Chapter 4). If your school bus has air brakes, you must also pass a knowledge test on Chapter 5. You must also pass the skills test required for the class of school bus you drive or intend to drive.

This chapter does not provide information on all the federal and state requirements needed before you drive a school bus. You should be thoroughly familiar with all specific school bus procedures, laws, and regulations in Idaho, the State Department of Education and your school district.

10.1 DANGER ZONES AND USE OF MIRRORS

10.1.1 Danger Zones

The "danger zone" is the area on all sides of the bus where children are in the most danger of being hit, either by another vehicle or their own bus. The danger zones may extend as much as 30 feet from the front bumper of which the first 10 feet is the most dangerous, 10 feet from the left and right sides of the bus and 10 feet behind the rear bumper of the school bus. In addition, the area to the left of the bus is always considered dangerous because of passing cars. **Figure 10.1** illustrates these danger zones.

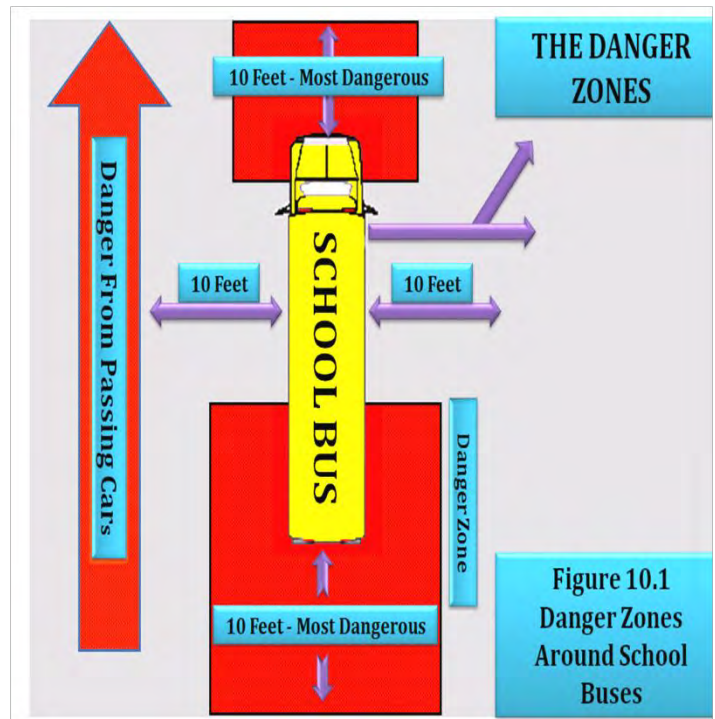

10.1.2 Correct Mirror Adjustment

Proper adjustment and use of all mirrors is vital to the safe operation of the school bus in order to observe the danger zone around the bus and look for students, traffic, and other objects in this area. You should always check each mirror before operating the school bus to obtain maximum viewing area. If necessary, have the mirrors adjusted.

10.1.3 Outside Left and Right Side Flat Mirrors

These mirrors are mounted at the left and right front corners of the bus at the side or front of the windshield. They are used to monitor traffic, check clearances and students on the sides and to the rear of the bus. There is a blind spot immediately below and in front of each mirror and directly in back of the rear bumper. The blind spot behind the bus could extend up to 400 feet depending on the width of the bus.

Ensure that the mirrors are properly adjusted so you can see:

- 200 feet or 4 bus lengths behind the bus.

- Along the sides of the bus.
- The rear tires touching the ground.

Figure 10.2 shows how both the outside left and right side flat mirrors should be adjusted:

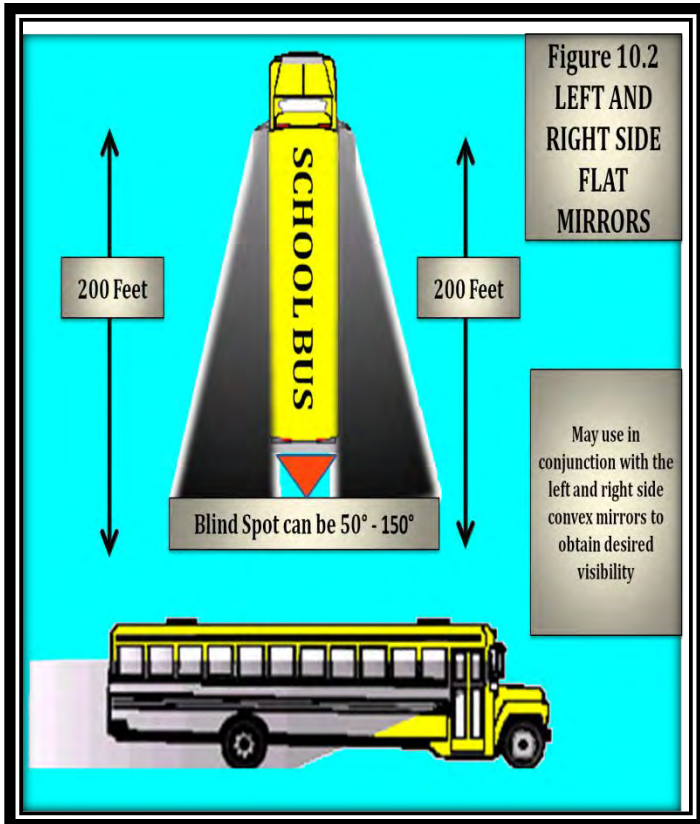

10.1.4 Outside Left and Right Side Convex Mirrors

The convex mirrors are located below the outside flat mirrors. They are used to monitor the left and right sides at a wide angle. They provide a view of traffic, clearances, and students at the side of the bus. These mirrors present a view of people and objects that does not accurately reflect their size and distance from the bus.

You should position these mirrors to see:

- The entire side of the bus up to the mirror mounts.
- Front of the rear tires touching the ground.
- At least one traffic lane on either side of the bus.

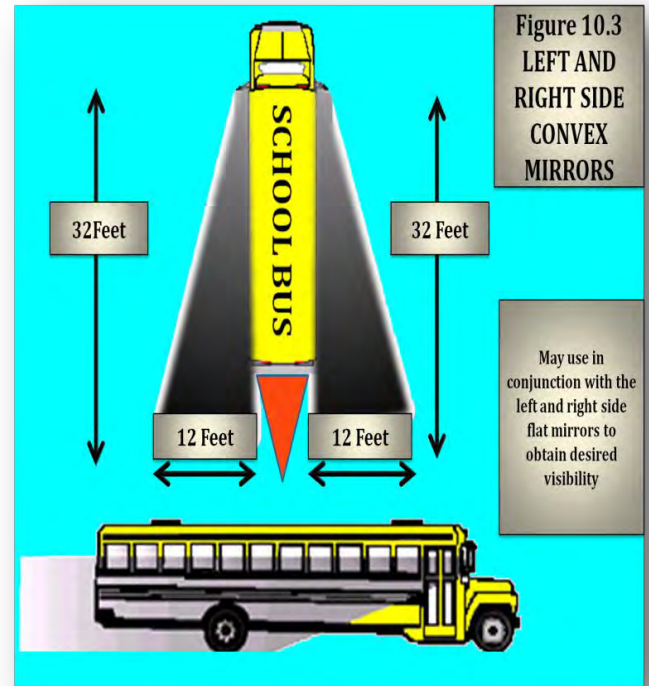
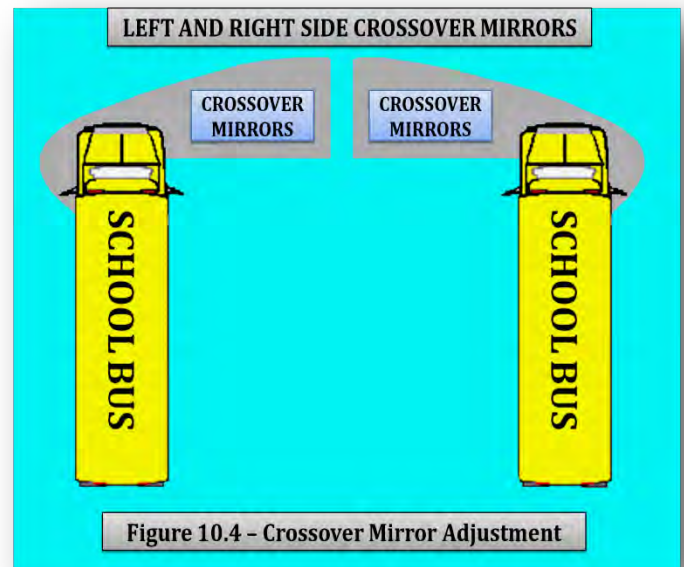

Figure 10.3 shows how both the outside left and right side convex mirrors should be adjusted.

10.1.5 Outside Left and Right Side Crossover Mirrors



These mirrors are mounted on both left and right front corners of the bus. They are used to see the front bumper “danger zone” area directly in front of the bus that is not visible by direct vision, and to view the

“danger zone” area to the left side and right side of the bus, including the service door and front wheel area. The mirror presents a view of people and objects that does not accurately reflect their size and distance from the bus. The driver must ensure that these mirrors are properly adjusted (**See Figure 10.4**).

Ensure that the mirrors are properly adjusted so you can see:

- The entire area in front of the bus from the front bumper at ground level to a point where direct vision is possible. Direct vision and mirror view vision should overlap.
- The right and left front tires touching the ground.
- The area from the front of the bus to the service door.
- These mirrors, along with the convex and flat mirrors, should be viewed in a logical sequence to ensure that a child or object is not in any of the danger zones.



Figure 10.4.a

10.1.6 Overhead Inside Rearview Mirror

This mirror is mounted directly above the windshield on the driver's side area of the bus. This mirror is used to monitor passenger activity inside the bus (**See Figure 10.4.a**). It may provide limited visibility directly in back of the bus if the bus is equipped with a glass-bottomed rear emergency door. There is a blind spot area directly behind the driver's seat as well as a large blind spot area that begins at the rear bumper and could extend up to 400 feet or more behind the bus. You must use the exterior side mirrors to monitor traffic that approaches and enters this area.

You should position the mirror to see:

- The top of the rear window in the top of the mirror.
- All of the students, including the heads of the students right behind you.

10.2 LOADING AND UNLOADING

More students are killed while getting on or off a school bus each year than are killed as passengers inside of a school bus. As a result, knowing what to do before, during, and after loading or unloading students is critical. This section will give you specific procedures to help you avoid unsafe conditions which could result in injuries and fatalities during and after loading and unloading students.

The information in this section is intended to provide a broad overview, but is not a definitive set of actions. It is imperative that you learn and obey the state laws and regulations governing loading/unloading operations in Idaho.

10.2.1 Approaching the Stop

Each school district establishes official routes and official school bus stops. All stops should be approved by the school district prior to making the stop. You should never change the location of a bus stop without

written approval from the appropriate school district official.

You must use extreme caution when approaching a school bus stop. You are in a very demanding situation when entering these areas. It is critical that you understand and follow all state and local laws and regulations regarding approaching a school bus stop. This would involve the proper use of mirrors, alternating flashing lights, moveable stop signal arm and crossing control arm.

When approaching the stop, you should:

- Approach cautiously at a slow rate of speed.
- Look for pedestrians, traffic, or other objects before, during, and after coming to a stop.
- Continuously check all mirrors.
- Activate alternating flashing amber warning lights at least 200 feet or approximately eight to ten seconds before the school bus stop or in accordance with Idaho law.
- Continuously check mirrors to monitor the danger zones for students, traffic, and other objects.
- Maintain your position in the center of the far right (curb-side) lane on multi-lane roadways, and in the center of the driving lane on two-lane roads (See Figures 10.4.b and 10.4.c).

Figure 10.4.b

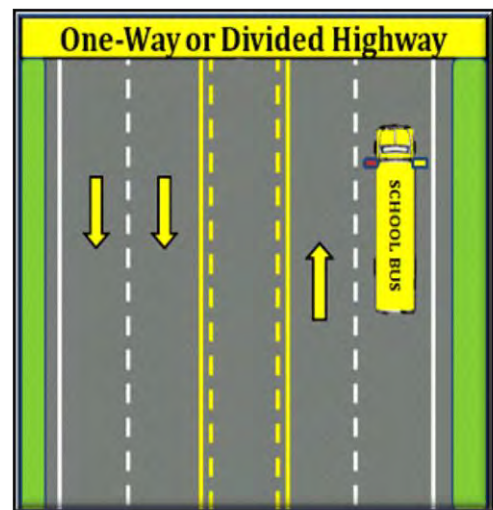
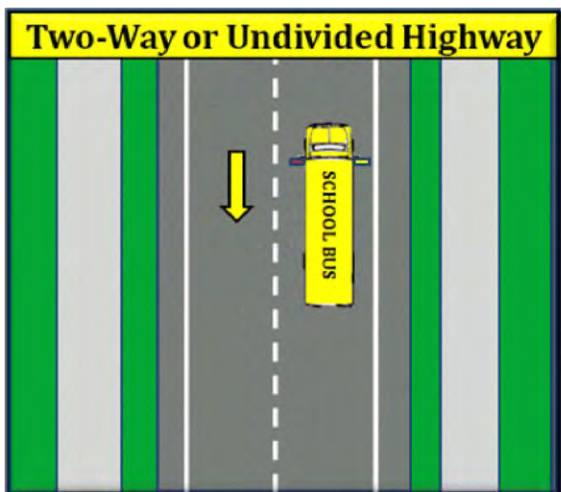

Figure 10.4.c

- Bring school bus to a full stop with the front bumper at least 10 feet away from students at the designated stop. This forces the students to walk to the bus so you have a better view of their movements.
- With your foot on the brake pedal, place the transmission in Neutral or Park. During the stop, either keep your foot on the brake pedal **or** set the parking brake.
- Open the service door, if possible, enough to activate the alternating red lights and deploy the stop arm and crossing control arm when traffic is a safe distance from the school bus.
- Make a final check to see that all traffic has stopped before completely opening the door and signaling the students to approach.

10.2.2 Loading Procedures

- Perform a safe stop as described in subsection 10.2.1.
- Students should wait in a designated location for the school bus, facing the bus as it approaches.
- Students should board the bus only when signaled by the driver.
- Monitor all mirrors continuously.

- Count the number of students at the bus stop and be sure all board the bus. If possible, know names of the students at each stop. If there is a student missing, ask the other students where the student is.
- Have the students board the school bus slowly, in single file, and use the handrail. The dome light should be on while loading in the dark.
- Wait until students are seated and facing forward before moving the bus.
- Check all mirrors. Make certain no one is running to catch the bus.
- If you cannot account for a student outside, secure the bus, take the key, and check around and underneath the bus.

When all students are accounted for and seated, prepare to leave by:

- Closing the door and deactivating the alternating flashing red lamps and withdrawing the stop arm and crossing control arm.
- Engaging the transmission.
- Releasing the service or parking brake.
- Checking traffic and all mirrors again.
- Allowing congested traffic to disperse.
- When it is safe to do so re-enter the traffic flow and continue the route.

The loading procedure is essentially the same wherever you load students, but there are slight differences. When students are loading at the school campus, you should:

- Turn off the ignition switch.
- Remove key if leaving driver's compartment.
- Position yourself to supervise loading as required or recommended by Idaho law, or the State Department of Education and/or school district regulations.

10.2.3 Unloading Procedures on the Route

- Perform a safe stop at designated unloading areas as described in subsection 10.2.1.
- Have the students remain seated until told to exit.
- Check all mirrors.
- Count the number of students while unloading to confirm the location of all students before pulling away from the stop.
- Tell students to exit the bus and walk at least 10 feet away from the side of the bus to a position where the driver can plainly see all students.
- Check all mirrors again. Make sure no students are around or returning to the bus.
- If you cannot account for a student outside the bus, turn off the ignition, take the key, secure the bus, go outside and check around and underneath the bus.

When all students are accounted for and seated, prepare to leave by:

- Closing the door and deactivating the alternating flashing red lamps and withdrawing the stop arm and crossing control arm.
- Engaging transmission.
- Releasing the service or parking brake.
- Checking all mirrors again.
- When it is safe to do so accelerate smoothly and re-enter the traffic flow and continue the route.

Note: If you have missed a student's unloading stop, do not back up. Be sure to follow local procedures.

Additional Procedures for Students That Must Cross the Roadway: You should understand what students should do when exiting a school bus and crossing the street in front of the bus. In addition, the school bus

driver should understand that students might not always do what they are supposed to do. If a student or students must cross the roadway, they should follow these procedures:

- The student(s) should walk approximately 10 feet away from the side of the school bus to a position where you can see them.
- The student(s) should walk to a location at least 10 feet in front of the right corner of the bumper, but still remaining away from the front of the school bus.
- The student(s) should stop at the right edge of the roadway. You should be able to see their feet.

When the students reach the edge of the roadway, they should:

- Stop and look in all directions, making sure the road-way is clear and is safe.
- Check to see if the red flashing lights on the bus are still flashing.
- Wait for your signal before crossing the roadway.

Upon your signal (i.e., hand motion from right to left), the students should:

- Cross far enough in front of the school bus to be in your view.
- Walk to the left edge of the school bus, stop, and look again for your signal to continue to cross the roadway.
- Look for traffic in both directions, making sure the roadway is clear.
- Proceed across the roadway, continuing to look in all directions.

It is important to understand that any hand (or other) signals given to students could be misinterpreted by motorists that are stopped in the area.

10.2.4 Unloading Procedures at School

State and local laws and regulations regarding unloading students at schools, particularly in situations where such activities take place in the school parking lot or other location that is off the traveled roadway, are often different than unloading along the school bus route. It is important that the school bus driver understands and obeys state and local laws and regulations. The following procedures are meant to be general guidelines.

When unloading at the school you should follow these procedures:

- Perform a safe stop at designated unloading areas as described in subsection 10.2.1.

- **Secure the bus by:**

 Placing the transmission in neutral or park.

 Setting the parking brake.

 Turning off the ignition switch.

 Removing the key if leaving driver's compartment.

- Have the students remain seated until told to exit.

- Position yourself to supervise unloading as required or recommended by your state or local regulations.

- Have students exit in orderly fashion.

- Observe students as they step from the bus to see that all move promptly away from the unloading area.

- Walk through the bus and check for hiding/sleeping students and items left by students.

- Check all mirrors. Make certain no students are returning to the bus.

- If you cannot account for a student outside the bus and the bus is secure, take the key and check around and underneath the bus.
- **When all students are accounted for, prepare to leave by:**
 - Closing the door.
 - Fastening safety belt.
 - Starting engine.
 - Engaging the transmission.
 - Releasing the parking brake.
 - Turning on left turn signal.
 - Checking all mirrors again
 - Allowing congested traffic to disperse.
- When it is safe, pull away from the unloading area.

10.2.5 Special Dangers of Loading and Unloading

Dropped or Forgotten Objects: Always focus on students as they approach the bus and watch for any who disappear from sight.

Students may drop an object near the bus during loading and unloading. Stopping to pick up the object, or returning to pick up the object may cause the student to disappear from the driver's sight at a very dangerous moment.

Students should be told to leave any dropped object and move to a point of safety out of the danger zones and attempt to get the driver's attention to retrieve the object.

Handrail Hang-ups: Students have been injured or killed when clothing, accessories, or even parts of their body get caught in the handrail or door as they exited the bus. You should closely observe all students exiting the bus to confirm that they are in a safe location prior to moving the bus.

10.2.6 Pre-trip and Post-trip Inspection

Pre-trip: Since the State of Idaho has adopted the FMSCR for school bus operations, you must perform a pre-trip safety inspection of your bus at the beginning of each workday/shift and prepare a Driver Vehicle Inspection Report. You **must** review the last driver vehicle inspection report at the beginning of your shift to ensure any items listed on the last report that affect the safety of the bus have been repaired or were found to be unnecessary by the mechanic performing the repairs. The mechanic must certify the repairs were performed by placing his/her signature on the original inspection report. You **must** sign the same report certifying you have reviewed the report and accept the bus. You do not have to sign a report from the previous driver if no defects or deficiencies were noted.

Post-trip: You must perform a post-trip safety inspection of your bus at the end of each shift, and you **must** prepare a written inspection report on each bus operated. You must identify the bus(s) you operated and list any defect or deficiency that would affect the safe operation of the bus that would cause it to suffer a mechanical breakdown. You **must** also prepare a written report if no equipment defect or deficiency is found. In all instances, you **must** sign the report. The Driver's Inspection Report notifies your company of the condition of the bus and identifies any defects or deficiencies found that would make the bus unsafe or cause it to break down. Depending on your company's policy regarding the distribution of the inspection report, if possible, you should leave a copy of the inspection report in the bus for at least a day so it can be reviewed by the next driver.

During your inspection of the bus, you should walk both through and around the vehicle looking for the following:

- Articles left on the bus.
- Sleeping students.
- Open windows and doors.
- Mechanical/operational problems with the bus, with special attention to items that are unique to school buses – mirror systems, flashing warning lamps and stop signal arms.

- Damage and/or vandalism.

Any problems or special situations should be reported immediately to your supervisor or school authorities.

10.3 EMERGENCY EXIT AND EVACUATION

An emergency situation can happen to anyone, anytime, anywhere. It could be a crash, a stalled school bus on a railroad-highway crossing or in a high-speed intersection, an electrical fire in the engine compartment, a medical emergency to a student on the school bus, etc. Knowing what to do in an emergency before, during, and after an evacuation can mean the difference between life and death.

10.3.1 Planning for Emergencies

Determine Need to Evacuate Bus: The first and most important consideration is for you to recognize the hazard. If time permits, school bus drivers should contact their dispatcher to explain the situation before making a decision to evacuate the school bus.

As a general rule, student safety and control is best maintained by keeping students on the bus during an emergency and/or impending crisis situation, if so doing does not expose them to unnecessary risk or injury. Remember, the decision to evacuate the bus must be a timely one.

A decision to evacuate should include consideration of the following conditions:

- Is there a fire or danger of fire?
- Is there a smell of raw or leaking fuel?
- Is there a chance the bus could be hit by other vehicles?
- Is the bus in the path of a sighted tornado or rising waters?
- Are there downed power lines?
- Would removing students expose them to speeding traffic, severe weather, or a dangerous environment such as downed power lines?

- Would moving students complicate injuries such as neck and back injuries and fractures?
- Is there a hazardous spill involved? Sometimes, it may be safer to remain on the bus and not come in contact with the material.

Mandatory Evacuations: The driver must evacuate the bus when-

- ! The bus is on fire or there is a threat of a fire.
- ! The bus is stalled on or adjacent to a railroad-highway crossing.
- ! The position of the bus may change and increase the danger.
- ! There is an imminent danger of collision.
- ! There is a need to quickly evacuate because of a hazardous materials spill.

10.3.2 Evacuation Procedures

Be Prepared and Plan Ahead: When possible, assign two responsible, older student assistants to each emergency exit. Teach them how to assist the other students off the bus. Assign another student assistant to lead the students to a “safe place” after evacuation. However, you must recognize that there may not be older, responsible students on the bus at the time of the emergency. Therefore, emergency evacuation procedures must be explained to all students. This includes knowing how to operate the various emergency exits and the importance of listening to and following all instructions given by you or other responsible adults (law enforcement, emergency responders, etc.).

Some tips to determine a safe place:

- A safe place will be at least 100 feet off the road in the direction of oncoming traffic. This will keep the students from being hit by debris if another vehicle collides with the bus.
- Lead students upwind of the bus if fire is present.

- Lead students as far away from railroad tracks as possible, and in the direction of any oncoming train.
- Lead students upwind of the bus at least 300 feet if there is a risk from spilled hazardous materials.
- If the bus is in the direct path of a sighted tornado and evacuation is ordered, escort students to a nearby ditch or culvert if shelter in a building is not readily available, and direct them to lie face down, hands covering their head. They should be far enough away so the bus cannot topple on them. Avoid areas that are subject to flash floods.

General Procedures: Determine if evacuation is in the best interest of safety.

Determine the best type of evacuation:



Front, rear or side door evacuation, or some combination of doors.



Roof or window evacuation.

- Secure the bus by:
 - Placing transmission in Park, or if there is no shift point, in Neutral.
 - Setting parking brakes.
 - Shutting off the engine.
 - Removing ignition key.
 - Activating hazard warning lights
- If time allows, notify dispatch office of evacuation location, conditions, and type of assistance needed.
- Dangle radio microphone or telephone out of driver’s window for later use, if operable.
- If no radio or the radio is inoperable, dispatch a passing motorist or area resident to call for help. As a last resort, send two older, responsible students to go for help.

- Order the evacuation.
- Evacuate students from the bus.

Do not move a student you believe may have suffered a neck or spinal injury unless his or her life is in immediate danger.

Special procedures must be used to move neck spinal injury victims to prevent further injury.

- Direct a student assistant to lead students to the nearest safe place.
- Walk through the bus to ensure no students remain on the bus. Retrieve emergency equipment.
- Join waiting students. Account for all students and check for their safety.
- Protect the scene. Set out emergency warning devices as necessary and appropriate.
- Prepare information for emergency responders.

10.4 RAILROAD-HIGHWAY CROSSINGS

10.4.1 Types of Crossings

Passive Crossings: This type of crossing does not have any type of traffic control device. You must stop at these crossings and follow proper procedures. However, the decision to proceed rests entirely in your hands. Passive crossings require you to recognize the crossing, search for any train using the tracks and decide if there is sufficient clear space to cross safely. Passive crossings have yellow circular advance warning signs, pavement markings and crossbucks to assist you in recognizing a crossing.

Active Crossings: This type of crossing has a traffic control device installed at the crossing to regulate traffic at the crossing. These active devices include flashing red lights, with or without bells and flashing red lights with bells and gates.

10.4.2 Warning Signs and Devices

Advance Warning Signs: The round, black-on-yellow warning sign is placed ahead of a public railroad-highway crossing. The advance warning sign tells you to slow down, look and listen for the train, and be prepared to stop at the tracks if a train is coming (See Figure 10.6).

Pavement Markings: Pavement markings mean the same as the advance warning sign. They consist of an "X" with the letters "RR" and a no-passing marking on two-lane roads. There may be a white stop line painted on the pavement before the railroad tracks. The front of the school bus must remain behind this line while stopped at the crossing (See Figure 10.6).

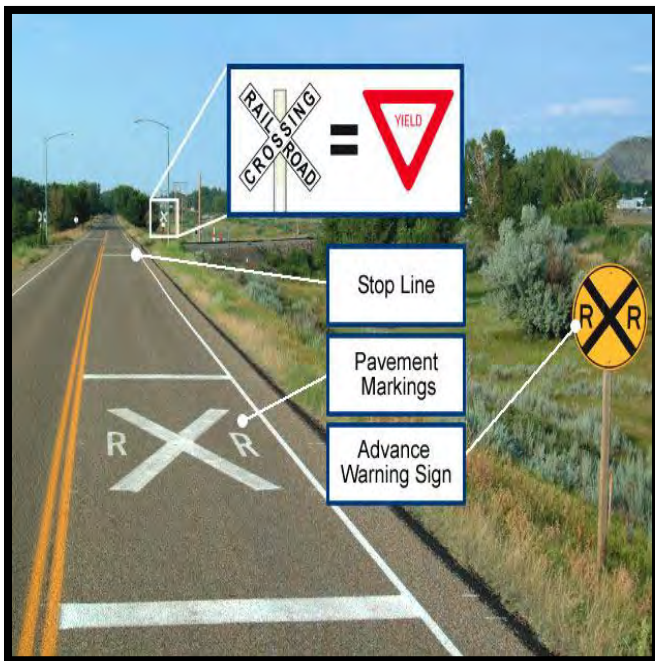

Figure 10.6

Crossbuck Signs: This sign marks the crossing. It requires you to yield the right-of-way to the train. If there is no white line painted on the pavement, you must stop the bus before the crossbuck sign. When the road crosses over more than one set of tracks, a sign below the crossbuck indicates the number of tracks (See Figure 10.7).



Figure 10.7

Flashing Red Light Signals: At many highway-rail grade crossings, the crossbuck sign has flashing red lights and bells. When the lights begin to flash, stop! A train is approaching. You are required to yield the right-of-way to the train.

If there is more than one track, make sure all tracks are clear before crossing (See Figure 10.8).



Figure 10.8

10.4.3 Recommended Procedures

Each state has laws and regulations governing how school buses must operate at railroad-highway crossings. It is important for you to understand and obey these state laws and regulations. Idaho Code §33-1508(2)(a) requires all school buses (with passengers or empty) must stop at all railroad crossings, and ensure it is safe before proceeding across the tracks.

A school bus is one of the safest vehicles on the highway. However, a school bus does not have the slightest edge when involved in a crash with a train. Because of a train's size and weight, it cannot stop quickly. An emergency escape route does not exist for a train. You can prevent school bus/train crashes by following these recommended procedures.

Approaching the Crossing:

- Slow down, including shifting to a lower gear in a manual transmission bus, and test your brakes.
- Activate hazard lights approximately 100 feet before the crossing. Make sure your intentions are known.
- Scan your surroundings and check for traffic behind you.

- Stay to the right of the roadway if possible.
- Choose an escape route in the event of a brake failure or problems behind you.

At the Crossing:

- Stop no closer than 15 feet and no farther than 50 feet from the nearest rail, where you have the best view of the tracks.
- Use your service brake (brake pedal) or parking brake to hold the bus stationary. Place the transmission in Neutral or Park. Follow school district and/or company policy regarding the gear position of the transmission and whether to use your service brake or parking brake (some school districts or companies allow the driver to leave the transmission in gear and only use the brake pedal to hold the bus in position).
- Turn off all radios and noisy equipment, and silence the passengers.
- Open the service door and driver's window.
- Look and listen for an approaching train.

Crossing the Track:

- Check the crossing signals again and close the service door before proceeding.
- At a multiple-track crossing, stop only before the first set of tracks. When you are sure no train is approaching on any track, proceed across all of the tracks until you have completely cleared them.
- Cross the tracks in a low gear. Do not change gears while crossing.
- If the gate comes down after you have started across, drive through it even if it means you will break the gate.

10.4.4 Special Situations

Bus Stalls or Trapped on Tracks: If your bus stalls or is trapped on the tracks, get everyone out of the bus and off the tracks immediately. Move everyone far from the

bus at an angle, which is both away from the tracks and toward the train, because if the train hits the bus, debris from the crash will go forward and not hit you and/or your students.

Police Officer at the Crossing: If a police officer is at the crossing, obey directions. If there is no police officer, and you believe the signal is malfunctioning, call your dispatcher to report the situation and ask for instructions on how to proceed.

Obstructed View of Tracks: Plan your route so it provides maximum sight distance at highway-rail grade crossings. Do not attempt to cross the tracks unless you can see far enough down the track to know for certain that no trains are approaching. Passive crossings are those that do not have any type of traffic control device. Be especially careful at "passive" crossings. Even if there are active railroad signals that indicate the tracks are clear, you must stop, look and listen to be sure it is safe to proceed.

Containment or Storage Areas: If it won't fit, don't commit! Know the length of your bus and the size of the containment area at highway-rail crossings on the school bus route, as well as any crossing you encounter in the course of a school activity trip. When approaching a crossing with a signal or stop sign on the opposite side, pay attention to the amount of room there is between the intersection and the tracks. Be certain the bus has enough containment or storage area to completely clear the railroad tracks on the other side if there is a need to stop. As a general rule, add 15 feet to the length of the school bus to determine an acceptable amount of containment or storage area.

10.5 STUDENT MANAGEMENT

The following information is a general guide for managing students on and off the bus. In all cases, follow the Idaho State Department of Education, school district and/or company policies regarding student management.

10.5.1 Student Behavior Problems When Loading and Unloading

In order to get students to and from school safely and on time, you need to be able to concentrate on the driving task.

Loading and unloading requires all your concentration. Don't take your eyes off what is happening outside the bus.

If there is a behavior problem on the bus, wait until the students unloading are safely off the bus and have moved away. If necessary, pull the bus over to handle the problem.

Special Note: The school bus driver should follow employer's policies / recommendations concerning enforcement of any state or local regulations regarding student actions outside the school bus.

10.5.2 Handling Serious Problems

Tips on handling serious problems:

- Follow your school's procedures for discipline or refusal of rights to ride the bus.
- Stop the bus. Park in a safe location off the road, perhaps a parking lot or a driveway.
- Secure the bus. Take the ignition key with you if you leave your seat.
- Stand up and speak respectfully to the offender or offenders. Speak in a courteous manner with a firm voice. Remind the offender of the expected behavior. Do not show anger, but do show that you mean business.
- If a change of seating is needed, request that the student move to a seat near you.
- Never put a student off the bus except at school or at his or her designated school bus stop. If you feel that the offense is serious enough that you cannot safely drive the bus, call for a school administrator or the police to come and remove the student. Always follow your state or local procedures for requesting assistance.

10.6 ANTILOCK BRAKING SYSTEMS

10.6.1 Vehicles Required to Have Antilock Braking Systems

The Department of Transportation requires that antilock braking systems be on:

- Air brakes vehicles, (trucks, buses, trailers and converter dollies) built on or after March 1, 1998.
- Hydraulically braked trucks and buses with a gross vehicle weight rating of 10,000 lbs or more built on or after March 1, 1999.

Many buses built before these dates have been voluntarily equipped with ABS. Your school bus will have a yellow ABS malfunction lamp on the instrument panel if it is equipped with ABS.

10.6.2 How ABS Helps You

When you brake hard on slippery surfaces in a vehicle without ABS, your wheels may lock up. When your steering wheels lock up, you lose steering control. When your other wheels lock up, you may skid or even spin the vehicle.

ABS helps you avoid wheel lock up and maintain control. You may or may not be able to stop faster with ABS, but you should be able to steer around an obstacle while braking, and avoid skids caused by over braking.

10.6.3 Braking with ABS

When you drive a vehicle with ABS, you should brake as you always have. In other words:

- Use only the braking force necessary to stop safely and stay in control.
- Brake the same way, regardless of whether you have ABS on the bus. However, in emergency braking, do not pump the brakes on a bus with ABS.
- As you slow down, monitor your bus and back off the brakes (if it is safe to do so) to stay in control.

10.6.4 Braking if ABS is Not Working

Without ABS, you still have normal brake functions. Drive and brake as you always have. Vehicles with ABS have yellow malfunction lamps to tell you if something is not working. The yellow ABS malfunction lamp is on the bus's instrument panel. (See Figure 10.9)



Figure 10.9

As a system check on newer vehicles, the malfunction lamp comes on at start-up for a bulb check and then goes out quickly. On older systems, the lamp could stay on until you are driving over five mph. If the lamp stays on after the bulb check, or goes on once you are traveling, you may have lost ABS control at one or more wheels.

Remember, if your ABS malfunctions, you still have regular brakes. Drive normally, but get the system serviced soon.

10.6.5 Safety Reminders

- ABS won't allow you to drive faster, follow more closely, or drive less carefully.
- ABS won't prevent power or turning skids. ABS should prevent brake-induced skids but not those caused by spinning the drive wheels or going too fast in a turn.
- ABS won't necessarily shorten stopping distance. ABS will help maintain vehicle control, but not always shorten stopping distance.
- ABS won't increase or decrease ultimate stopping power. ABS is an "add-on" to your normal brakes, not a replacement for them.
- ABS won't change the way you normally brake.
- Under normal brake conditions, your vehicle will stop as it always stopped. ABS only comes

into play when a wheel would normally have locked up because of over braking.

- ABS won't compensate for bad brakes or poor brake maintenance.
- Remember: The best vehicle safety feature is still a safe driver.
- Remember: Drive so you never need to use your ABS.
- Remember: If you need it, ABS could help to prevent a serious crash.
- During an emergency stop when hard braking is required, apply continuous pressure on the brake pedal. **Do Not Pump The Brake Pedal** as this will defeat the system's design and reduce the effectiveness of the ABS and cause the vehicle to increase its stopping distance. The ABS will activate immediately, allowing you to retain full steering control during hard braking and on slippery surfaces; however, ABS does not decrease stopping distances.
- During hard braking with ABS, the system actually pumps the brakes for you at a higher rate than you could do yourself. This pumping action causes a noise from the ABS pump motor, and you may feel a noticeable pulse through the brake pedal. Do not be concerned by the noise and pulsation, because this is normal. Knowing you will hear the pump motor and feel the pulse will help you resist the natural instinct to remove your foot from the pedal.

10.7 SPECIAL SAFETY CONSIDERATIONS

10.7.1 Strobe Lights

Some school buses are equipped with roof-mounted, white strobe lights. If your bus is so equipped, the overhead strobe light should be used when you have limited visibility. This means that you cannot easily see around you - in front, behind, or beside the school bus. Your visibility could be only slightly limited or it could be so bad that you can see nothing at all. In all instances, understand and obey your state or local regulations concerning the use of these lights.

10.7.2 Driving in High Winds

Strong winds affect the handling of the school bus! The side of a school bus acts like a sail on a sailboat. Strong winds can push the school bus sideways. They can even move the school bus off the road or, in extreme conditions, tip it over. If you are caught in strong winds:

- Keep a strong grip on the steering wheel. Try to anticipate gusts.
- You should slow down to lessen the effect of the wind, or pull off the roadway and wait.
- Contact your dispatcher to get more information on how to proceed.

10.7.3 Backing

Backing a school bus is strongly discouraged. You should back your bus only when you have no other safe way to move the vehicle. You should never back a school bus when students are outside of the bus. Backing is dangerous and increases your risk of a collision. If you have no choice and you must back your bus, follow these procedures:

- Post a lookout inside the bus. The purpose of the lookout is to warn you about obstacles, approaching persons, and other vehicles. The lookout should not give directions on how to back the bus.
- Signal for quiet on the bus.
- Constantly check all mirrors and rear windows.
- Activate Four-Way emergency flashers
- Honk horn twice
- Back slowly and smoothly.
- If no lookout is available:
 - Set the parking brake.
 - Turn off the motor and take the keys with you.

- Walk to the rear of the bus to determine whether the way is clear.

- If you must back-up at a student pick-up point, be sure to pick up the students before backing and watch for late comers at all times.
- Be sure that all students are in the bus and seated before backing.
- If you must back-up at a student drop-off point, be sure to unload students after backing.

10.7.4 Tail Swing

A school bus can have up to a three foot tail swing. You need to check your mirrors before and during any turning movements to monitor the tail swing. (See figure 10.10)



Figure 10.10 An example of Tail Swing

Section 10

Test Your Knowledge

1. Define the danger zone. How far does the danger zone extend around the bus?
2. What should you be able to see if the outside flat mirrors are adjusted properly? The outside convex mirrors? The crossover mirrors?
3. You are loading students along the route. When should you activate your alternating flashing amber warning lights?
4. You are unloading students along your route. Where should students walk to after exiting the bus?
5. After unloading at school, why should you walk through the bus?
6. What position should students be in front of the bus before they cross the roadway?
7. Under what conditions must you evacuate the bus?
8. How far from the nearest rail should you stop at a highway-rail crossing?
9. What is a passive highway-rail crossing? Why should you be extra cautious at this type of crossing?
10. How should you use your brakes if your vehicle is equipped with antilock brakes (ABS)?

These questions may be on your test. If you can't answer them all, re-read Chapter 10

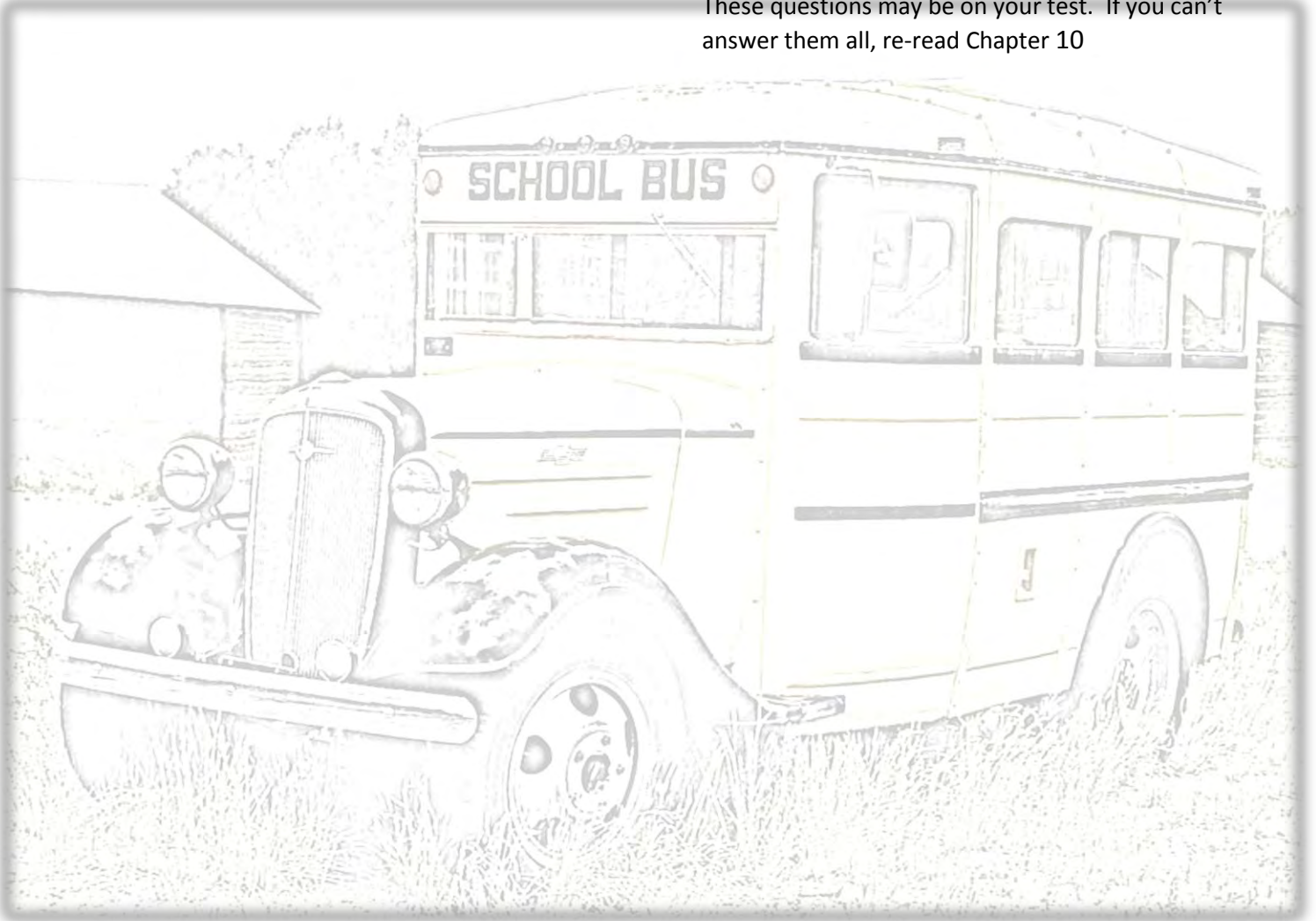

Chapter 11 : PRE-TRIP INSPECTION TEST

This Chapter Covers:



External Inspection



Internal Inspection

General Information: This chapter will identify the inspection criteria for all of the required components on various types of vehicles (trucks/tractor, trailers, school, coach and transit buses).

The first section applies to all vehicles. Both trucks and busses share the same type of drivetrain and suspension components.

The second and third sections are specific to school and coach busses. **NOTE: Both school and coach/transit bus applicants must inspect the same tire, wheel, brake, suspension, and under-vehicle components as truck applicants. Coach bus operators must memorize these components and describe them to the examiner, even though some of the components may not be visible while conducting the pre-trip inspection.**

During the pre-trip inspection, you will demonstrate that the vehicle is safe to drive. You will walk around the vehicle and point to or touch each item to be inspected. You will explain to the examiner what you are checking and why. You will NOT have to crawl under the hood or under the vehicle.

Third Party Testers: Third Party Testers conduct CDL skills tests in Idaho. They are allowed to charge \$60 to administer the skills test. Once you have passed the required written tests and obtained a receipt for a skills test fee, you may make an appointment with a Third Party Tester. A list of testers is available at your Sheriff's Office (DMV), or online at www.itd.idaho.gov/dmv/driverservices/. Be sure to show up for your appointment. If you fail to show up, and later request a test, the examiner may be unable to test you.

Banking Parts of the Skills Test: The skills test is considered one test with three parts, not three separate tests; therefore, you must pass all three parts to successfully complete the test. Idaho does not allow "banking" parts of the test (i.e., being allowed to pass

one or two parts and only have to retest on the one you failed). If you fail any part of the test, you will be required to retake the entire three part test again following a three day waiting period.

Vehicle Used in the Test: Depending on your knowledge and skill level, it will usually take approximately 2 hours to complete the entire skills test. The test consists of a pre-trip vehicle inspection, a basic control skills test, and a driving test. You will need to provide a vehicle for the test or rent one from a tester who has rental vehicles available. Whether you use your own vehicle, a company vehicle, or one that is borrowed from a friend, you must have proof of insurance and current registration to use it for the test.

Be sure the vehicle is representative of the license you are seeking; for example a Class A vehicle with air brakes for a Class A license with air brake endorsement, and is in good condition and operational. If during the inspection, any item is found that makes the vehicle unsafe or prevents it from operating legally on the road, the test will be terminated by the examiner, and you will have to reschedule for another time.

Air Brake Restriction: If the vehicle used for the test is not equipped with air brakes, your CDL will show an air brake restriction (L) stating that you are not licensed to operate vehicles equipped with air brakes. Once you have successfully tested in a vehicle equipped with air brakes, you may test in other vehicle(s) without air brakes for additional endorsements and not have the restriction applied to your license (it's a one-time test).

Exact Terminology is not required: If you do not remember the technical name of a component but know the function of the component and properly inspect it, the examiner will give you credit for inspecting it.

Your vehicle may not have all the components shown in this chapter. You are only required to inspect components that are found on the vehicle you are using for the test.

For test purposes, each component is scored separately. For example, you will need to inspect the components on the front axle, the drive axle, and one trailer axle for a Class A vehicle.

Inspection Instructions: To receive credit for inspecting various components of the vehicle and/or trailer:

- 🚧 **You must point to or touch the vehicle components you are inspecting and tell the examiner what the components are.**
- 🚧 **You must tell the inspector what defects you are looking for if applicable. This is the only way that the examiner can assess your ability to inspect your vehicle to be sure it is safe to operate.**
- 🚧 **You will not receive credit for inspecting a component if you give the examiner general comments like, “Tire looks good”, “Brakes are OK”, etc.**
- 🚧 **Items found several places on the vehicle such as tires, rims, lug nuts, etc.: You need not repeat a complete inspection of each component item on each axle, but to obtain credit for the part, you must mention that you would inspect the component the same as you would on the axle you already inspected.**

NOTE: *Be careful when doing this! Each axle is different and minimum tire tread depths are different on steering and drive/ trailer tires. You need to practice inspecting each of the required axles to make sure you don't miss important components.*

The following is an example of the proper way to tell the examiner what you will be looking for when you inspect a component. To Inspect the Front Tire (Steering Axle):

Inspection Points to remember:

- Condition,
- Valve cap/stem
- 4/32" Tread Depth
- Inflation

You should tell the inspector:

“I’m checking the condition of the tire, to make sure the tire tread is evenly worn and it doesn’t have any cuts, bulges or other damage to the tread or sidewalls.

I’m checking to make sure the valve caps are on and the valve stem is not damaged or missing.

I’m checking to make sure the tread depth of the tire is at least 4/32 of an inch for the steering axle.

I would check the tire’s Inflation with a tire gauge to make sure it is properly inflated.”

You may inspect your vehicle in any order you wish, but you must be sure to inspect the engine compartment, the external components including the lights, the in-cab inspections, and the engine start-up checks. The examiner is allowed to assist you in inspecting the lights by observing them and letting you know they are functioning correctly; however, you must specifically tell the examiner which lights you want him/her to check as you activate them. The examiner will not prompt you for this information.

You should walk all the way around your vehicle checking for problems when conducting your pre-trip inspection; however, for the purposes of the test, you need only describe the tire checks, brake component, etc. on one side. Some components (battery box, fuel tank, etc.) may only be found on one side of the vehicle. If you are in doubt, be sure to walk all the way around as you would normally.

Components with Multiple Inspection Points: If a component has multiple inspection points, you must properly mention a majority of the inspection points to receive credit for the component. (The front tire, for example, has four inspection points to remember). You will find the inspection points for each component later in this chapter.

Practice the Pre-trip Inspection: Applicants fail the pre-trip inspection more than any other part of the skills test. If you fail any part of the skills test, you will have to take the entire three (3) part test again and pay additional fees, so **PRACTICE, PRACTICE, PRACTICE!**

You should practice the inspection on the vehicle you intend to use for the test. Study this chapter well and have a friend, co-worker or family member practice with you.

Pre-Trip Inspection Form: Airplane pilots use checklists to make sure their plane is safe to fly and to make sure they don’t skip important components in the inspection process. Likewise, a truck or bus driver should use a pre-trip inspection form to ensure they properly inspect their vehicle before beginning their trip.

A sample pre-trip checklist is in the back of this manual, along with a brake check memorization aid. It is recommended you cut out the checklist to help you learn the proper inspection items, or, make your own inspection list for the vehicle you will be taking to the test. You cannot take this form to the skills test, but it will assist you in memorizing the inspection

components as you see them on the vehicle you are inspecting.

A full size aid you can cut out is located in the back of this manual.



The memory aid cannot have any writing or notes on it. If you have notes on your inspection guide, the examiner will not allow you to use it for the test. If you have forgotten to bring the memory aid to the test, the examiner may have one you can use.

Grounds for Immediate Failure of the CDL Skills Test:
The applicant will automatically fail the entire test for any of the following reasons:

- Applicant fails to perform the air brake system check entirely or fails to perform all three of the checks correctly and in the correct order;
- Applicant fails to wear a seat belt during the Road Test;
- Applicant refuses or is unable to perform any maneuver which is part of the prescribed test;
- Applicant receives a traffic citation for a moving violation during the test;
- Applicant disobeys traffic signs and signals;
- Applicant does not yield the right-of-way to pedestrians or other vehicles;
- Applicant is involved in an avoidable crash or accident, or has physical contact with other vehicles, objects, pedestrians;
- Applicant commits a dangerous act causing vehicles or pedestrians to take evasive actions;
- Applicant puts vehicle over curbs or sidewalks unnecessarily, or
- Applicant commits a serious violation of a traffic law

CDL Vehicle Inspection Memory Aid: You may use a Vehicle Inspection Memory Aid from this manual to help you remember inspection items during the test. See Figure 11.1

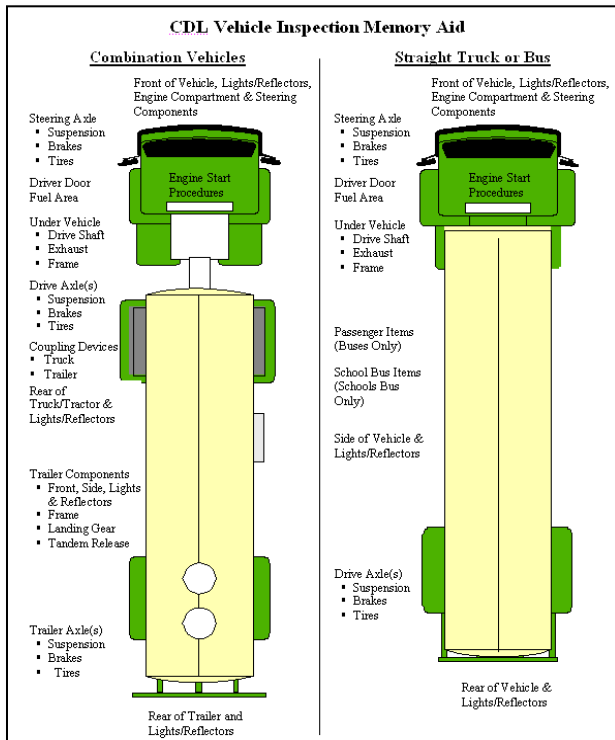

Figure 11.1 CDL Vehicle Inspection Memory Aid

The vehicle components in the following pages are listed in an order that may be the most logical to follow as you make an inspection.

11.1 UNDER VEHICLE

11.1.1 Exhaust System

Description: Piping for removing combustion gases from engine.

Rational: Leaks under the cab area can cause asphyxiation of the driver and/or passengers.

Inspection Points (Condition, Leaks, Secure):

- ✓ Check the exhaust system to ensure it is connected tightly, mounted securely and there are no loose clamps.
- ✓ Check the exhaust system (stack/tail pipe to engine) for damage and signs of leaking rust or carbon soot). The exhaust system should have no cracks, holes, or severe dents.



11.1.2 Drive Shaft

Description: Transmits power from transmission to drive axle.

Rational: Bent shaft, loose, or worn U-joints may cause excessive vibration. Loss of drive shaft could dig into pavement causing loss of vehicle control. Also, shaft may come off, hitting other traffic.

Inspection Points (Condition, Secure, Guards):

- ✓ Check to see that drive shaft is not bent, twisted, or cracked.
- ✓ Check that U-joints appear to be secure and free of foreign objects.
- ✓ Check guards (if present) to see they are secure and in good condition (Guards are only required on buses).



11.1.3 Frame

Description: Structural members for supporting vehicle body or trailer body.



Rationale: Loose cross members may reduce vehicle stability and cause handling and cornering problems (i.e., wandering, possible rollover). Welds and/or the frame may develop cracks and ultimately break, resulting in total loss of vehicle control.

Inspection Points (Condition, Broken Welds, Holes):

- ✓ Check for cracks, broken welds, or bends in longitudinal frame members.
- ✓ Check for loose, cracked, bent, broken, or missing cross members.
- ✓ Look for signs of breaks or holes in box or trailer floor.

Special Note: Cracks in members are most likely to appear midway between points of attachment to vehicle assemblies (i.e., half way between tractor cab and rear tractor wheels)

11.1.4 Leaks Under Vehicle

Description: Fluid leaks from engine or fuel tanks.

Rationale: Fluid loss could indicate component failure in areas where levels might not be readily checked (i.e., transmission, coolant, oil and fuel systems).

Inspection Points (Fluid and Fuel):

- ✓ Look for puddles or dripping fluids on the ground under the fuel tanks and engine, or the underside of the engine, and transmission.



11.2 LIGHTS/REFLECTORS/REFLECTOR TAPE

FRONT OF VEHICLE

11.2.1 Headlights (High & Low Beam/Dashboard Lighting Indicator):

Description: Headlights (high and low beam), and dashboard indicator light.

Inspection Points (High Beam and Low Beam):

- ✓ Check headlights operation (high and low beam)
- ✓ Check high beam dashboard indicator light to ensure it is working properly.
- ✓ Check to see that headlights are clean and not damaged.



11.2.2 Clearance Lights:

Description: Front clearance lights.

Inspection Points (Operation):

- ✓ Check clearance light for operation.
- ✓ Check to see that the clearance lights are clean and not damaged.



11.2.3 Four-Way Emergency Flashers:

Description: Front four-way emergency flashers.

Inspection Points (Operation):

- ✓ Check front emergency flashers to make sure both are operational.

11.2.4 Turn Signals (Left and Right):

Description: Front turn signals and dashboard indicator lights.

Inspection Points (Left and Right):

- ✓ Check left and right turn signals for proper operation.

SIDE OF VEHICLE/TRAILER(S)

11.2.5 Marker Lights:

Description: Side truck and/or trailer marker lights.

Rationale: Lights, reflectors and reflector tape allow the driver of a commercial to see and be seen and to communicate with other traffic.



Inspection Points (Condition, Operation):

- ✓ Check to see the marker lights are in proper working order.
- ✓ Check to see lenses are clean and not damaged or missing
- ✓ Check to see that amber lights are in the front of the vehicle/trailer and red lights are located on the rear of the vehicle/trailer.

11.2.6 Reflectors and/or Reflector Tape:

Description: Reflectors and/or reflector tape on sides of vehicle and/or trailer.

Rationale: Reflectors and/or reflector tape allow other traffic to see the side outline of the vehicle and/or trailer(s).

Inspection Points (Condition, Secure):

- ✓ Check all reflectors to see that they are clean, not missing or broken and are of proper color (red on rear, amber elsewhere).
- ✓ Check that the reflector tape is present, affixed securely the vehicle/trailer and clean.



REAR OF VEHICLE/TRAILERS

11.2.7 Clearance/Identification Lights:

Description: Clearance and rear identification lights mark the "overall width" of the design dimension of the widest part of the vehicle, exclusive of the signal lamps, marker lamps, outside rearview mirrors, flexible fender extension and mud flaps. Clearance and identification lamps are required on most buses, trucks and trailers that are 80 inches or more in overall width. Red light on rear corners of vehicle and/or trailer(s).



Inspection Points (Condition, Operation):

- ✓ Check to see that clearance and identification lights are clean, not damaged, red in color and operational. Identification lights can be either at the top or bottom of the trailer.

11.2.8 Reflectors and/or Reflector Tape:

Description: reflectors and/or reflector tape on rear of vehicle and/or trailer(s).

Inspection Points (Condition, Secure):

- ✓ Check that reflectors are clean, none are missing or broken, and they are of proper color (red).
- ✓ Check that reflector tape is present, clean and affixed securely to the vehicle.



11.2.9 Four-Way Emergency Flashers

Description: Rear emergency 4-way flashers on vehicle and/or trailer(s).

Inspection Points (Operational):

- ✓ Check that rear hazard light lenses are clean, not damaged and red or amber in color.
- ✓ Check that 4-way flashers are operational.

11.2.10 Turn Signals (Right & Left):

Description: Rear turn signals on vehicle and/or trailer(s).

Inspection Points:

- ✓ Check to see that lenses are clean, not damaged and red or amber in color.

- ✓ Check to see that both left and right turn signals are operational.

11.2.11 Brake Lights (Operational):

Description: Rear brake lights on rear of vehicle and/or trailer(s).

Inspection Points (Operational):

- ✓ Check to see that lenses are clean, not damaged and red in color.
- ✓ Check to see that brake lights come “on” when brakes are applied and turn “off” when brakes are released.

11.2.12 Tail Lights:

Description: Tail lights on rear of vehicle and/or trailer(s). Tail lights must be checked separately from signal, 4-way flasher and brake lights.

Inspection Points (Operational):

- ✓ Check to see that tail (running) lights are clean, not broken, and are red in color.
- ✓ Check to see that tail lights are operational.



Note: You may ask the examiner to assist you with these checks. You are responsible for telling the examiner exactly which lights you want him/her to inspect. The examiner cannot “cue” or assist you in remembering which lights you must inspect.

11.3 ENGINE COMPARTMENT

11.3.1 Oil Level:

Description: Dipstick used to measure amount of oil for engine lubrication

Rationale: Adequate lubrication extends engine life and prevents engine failure because of seizure.

Inspection Points:

- ✓ Check oil level while engine is off.
- ✓ Indicate where dipstick is located
- ✓ Check that oil level is above the refill mark, in a safe operating range.

Special Note: You will get credit for checking the oil by actually pulling the dipstick out (demonstrating) or explaining that the oil should be checked by pulling the dipstick out.

11.3.2 Coolant Level:

Description: Cools the engine



Rationale: Adequate coolant prevents engine failure due to over-heating in hot weather or freezing in cold weather.

Inspection Points:

- ✓ Look at sight glass on radiator or coolant reservoir; adequate level will show in sight glass. If no sight glass is available, the driver should describe what he/she would look for after removing the radiator cap.

Special Note: If the engine is hot, do not remove the radiator cap. If there is no sight glass or coolant reservoir, tell the examiner that the radiator cap would be removed to view presence of coolant

11.3.3 Power Steering Fluid:

Description: Hydraulic fluid for assisting steering wheel action to front wheels. Belt drives the power steering unit.

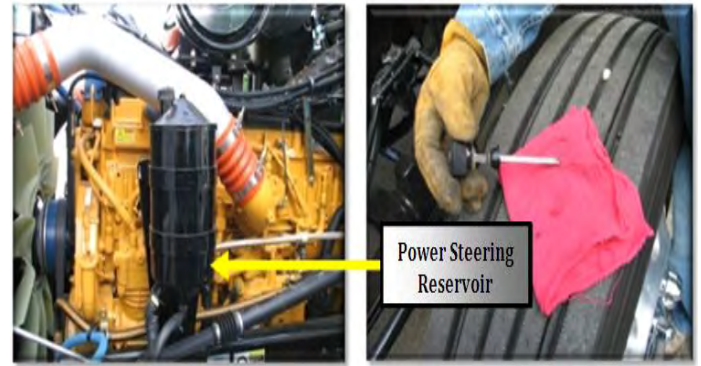

Rationale: Adequate fluid level and secure belt prevent hard steering and possible loss of vehicle control.

Inspection Points:

- ✓ With the engine stopped, check the dipstick and see where the fluid level is relative to the refill mark or checks sight glass. Level must be above refill mark.

Special Note: You will get credit for checking the power steering fluid by actually pulling the dipstick out (demonstrating) or explaining that the fluid should be checked by pulling the dipstick out.

11.3.4 Hydraulic Brake Fluid:

Description: Reservoir holding hydraulic brake fluid used to engage hydraulic brakes.

Inspection Points:

- ✓ Check the fluid level in the reservoir. Level should be above the refill mark (may point to and explain this process).

11.3.5 Air Compressor

Description: Maintains air pressure in air brake system and may be belt or gear driven. (Note: Belt is inspected with "engine compartment belts").

Rationale: Loss of air supply can result in sudden application of spring brakes leading to loss of vehicle control. In cases of low air pressure, the brakes may drag and overheat.

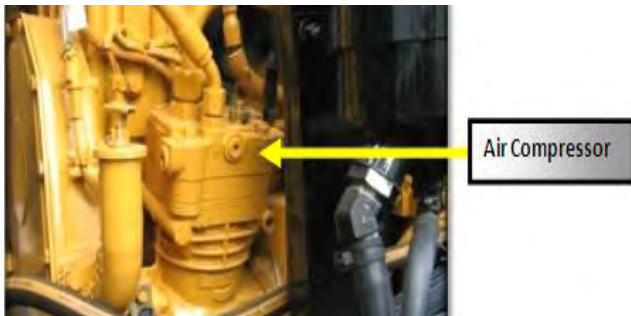

Inspection Points (Secure, Leaks, Belt):

- ✓ With engine off, point to or touch the air compressor.
- ✓ Check to see that the compressor is securely mounted and not leaking.
- ✓ If belt driven, push the belts inward to determine the amount of deflection. If the belt(s) deflects more than 1/2 to 3/4 of an inch, the belt might slip on the pulleys and should be adjusted.

11.3.6 Alternator:

Description: Alternating-current generator for charging the battery to power a vehicle's electrical system when the engine is running.

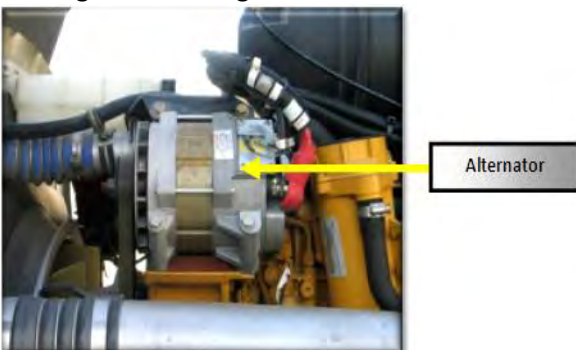

Inspection Points (Secure, Wiring, Belt):

- ✓ Check to see that alternator is securely mounted
- ✓ Check to see that all wires are securely fastened.
- ✓ Push the alternator belt inward to determine the amount of deflection. If the belt deflects more than 1/2 to 3/4 of an inch, the belt might slip on the pulleys and should be adjusted.

11.3.7 Water Pump

Description: Pumps coolant through engine block

Rationale: A leaking water pump can lead to loss of coolant and overheating of the engine. Most water pumps are belt driven. Loose belts will not turn the water pump and/or fan properly. This will result in overheating. Make sure coolant hoses are in good condition. A broken hose while driving can lead to engine failure and even fire.



Inspection Points (Secure, Leaks, Belt):

- ✓ With engine off, point to or touch the water pump.
- ✓ Check to see that the water pump is securely mounted and not leaking coolant.
- ✓ Push the belts inward to determine the amount of deflection. If the belt(s) deflects more than 1/2 to 3/4 of an inch, the belt might slip on the pulleys and should be adjusted.

11.3.8 Engine Leaks and Hoses:

Description: Fluid leaks from hoses in the engine compartment or other fluid leaking from engine block.

Rationale: Fluid on the engine could indicate a current or future component failure, loose bolts, or worn gaskets (i.e., water pump).

Inspection Points (Leaks):

- ✓ Check hoses in the engine compartment for leaks, damage or signs of excessive wear.
- ✓ Check hoses to make sure all connections are secure.
- ✓ Look for fluid leaks on and around the engine.

11.3.9 Engine Belts:

Description: All belts in the engine compartment including belts for the power steering mechanism, water pump, alternator/generator and air compressor.

Rationale: Belts are looped strips of flexible material, used to mechanically link two or more rotating shafts. They may be used as a source of motion, to efficiently transmit power, or to track relative movement.



Inspection Points (Condition, Deflection 1/2" – 3/4"):

- ✓ Check to see that engine belt(s) are not worn, frayed or cracked.
- ✓ Push the belts inward to determine the amount of deflection. If the belt(s) deflects more than 1/2 to 3/4 of an inch, the belt might slip on the pulleys and should be adjusted.

11.3.10 Engine Fan:

Description: Engine coolant goes into the radiator to dissipate the heat that it collected in the engine. The heat is drawn off by air passing through the radiator. If the vehicle is not moving fast enough to push air through the radiator, the fan will come on and pull the air through. The fan can be mounted on the water pump shaft or elsewhere on the engine and can be powered by the same belt that runs the water pump or electrically. Running the fan takes power from the engine, so it's only turned on when it is needed. The fan is controlled by a thermostat switch that tells it when the temperature has risen to a point where the fan is needed.

Rationale: Most radiator cooling fans are powered by the engine or by electricity. When a cooling fan fails, it causes the coolant to retain heat, forcing the engine to run hot and eventually over heat. A fan that breaks free of its mountings can strike the radiator and damage it severely. The cooling fan must be maintained regularly as part of the cooling system. This includes checking the condition of the blades (check for cracks or nicks) as fan blades that are not balanced can set up harmonic vibrations that can destroy water pump bearings and other related components, leading to total system failure.

Inspection Points (Secure, Condition):

- ✓ Check to see that fan is securely mounted.
- ✓ Check fan for missing and/or damaged blades.



11.4 STEERING COMPONENTS

11.4.1 Steering Box:

Description: Container (and hoses) for mechanism that transform steering column action into wheel turning action.

Rationale: Loose bolts or cracks in the steering box could result in loss of steering if the gear box or steering wheel shaft become partially or fully disconnected.

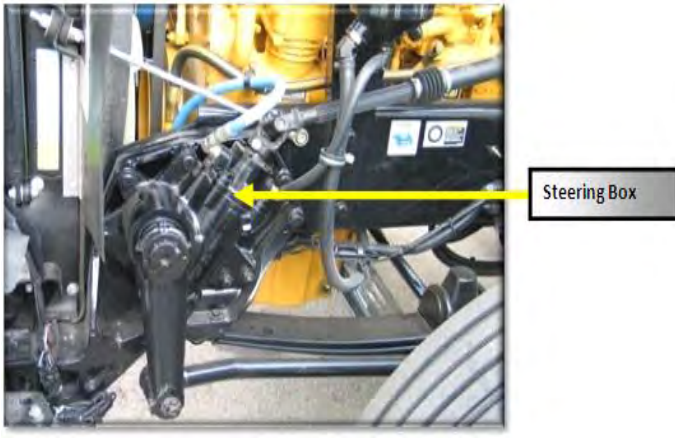

Inspection Points (Secure, Leaks):

- ✓ Check that the steering box is securely mounted and not leaking.
- ✓ Look for any missing nuts and bolts.
- ✓ Check to see that steering box is in good condition and not damaged.

11.4.2 Steering Box Hoses

Description: Transmits power steering fluid to the steering box.

Inspection Points (Secure, Condition, Leaks):

- ✓ Check condition of hoses for abrasions, cuts or other damage.
- ✓ Check to see that hose connections are secure.
- ✓ Check to see hoses are not leaking.

11.4.3 Steering Linkage:

Description: Transmits steering action from steering box to wheel

Rationale: Worn, loose, or broken steering parts (i.e., drag link, pitman arm, tie rod ends, etc.) can cause loss of steering action. Excessive movement in the linkage can cause the vehicle to wander or experience other serious control problems.

Inspection Points (Secure, Condition):

- ✓ Check that connecting links, arms, and rods from the steering box to the wheel are not worn or cracked.
- ✓ Check that joints and socket are not worn or loose.
- ✓ Check for loose or missing nuts, bolts, or cotter pins.

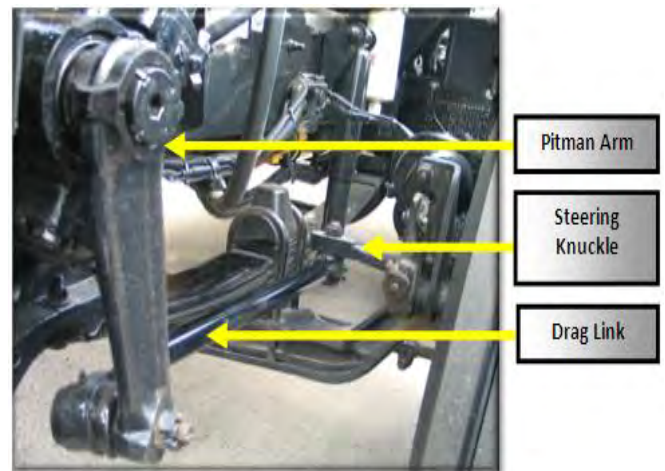

11.5 SUSPENSION- FRONT AXLE

11.5.1 Springs:

Description: Leaf or coil springs which reduce wheel vibrations created by the road surface.

Rationale: Damaged or missing leaves may lead to a loss of control or a rollover if the vehicle falls on the frame or on a tire. Shifted springs may strike a tire, causing a blowout or interference with steering.

Inspection Points (Condition, Secure):

- ✓ Look for missing, shifted, cracked, or broken leaf springs.
- ✓ Look for broken or distorted coil springs.

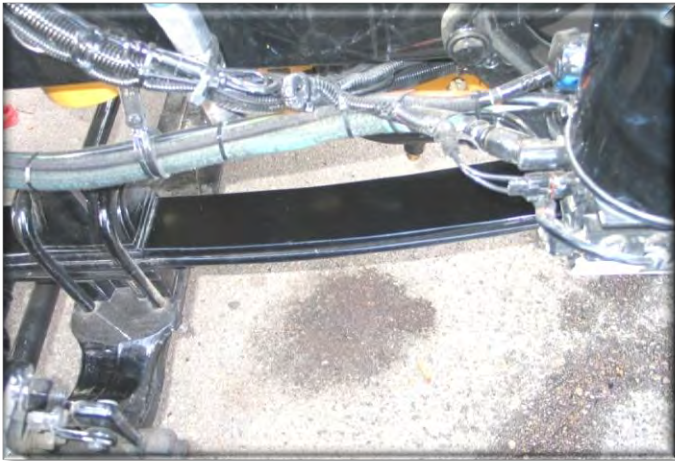

11.5.2 Spring Mounts:

Description: All brackets, bolts, and bushings used for attaching spring and/or air bag to vehicle frame.

Rationale: Loose, worn, or broken components may lead to loss of vehicle control or rollover.

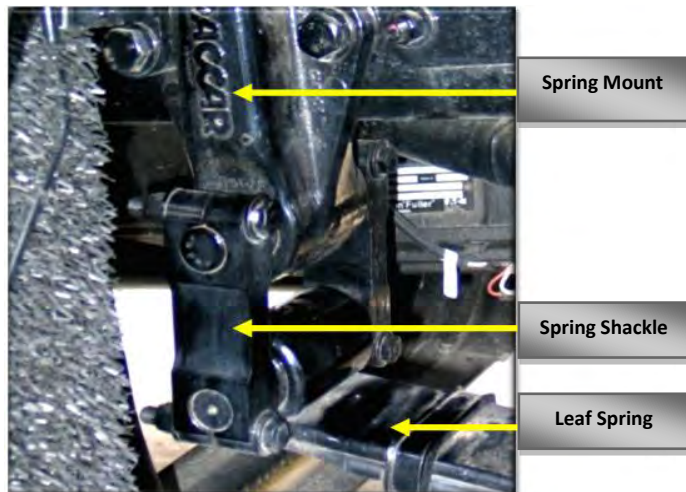

Inspection Points (Condition, Secure):

- ✓ Check that spring attachments (brackets, bolts, bushings) are in place.
- ✓ Check for cracked or broken spring hangers.

- ✓ Check for missing or damaged bushings.

11.5.3 U-Bolts:

Description: U-bolts secure the springs to the axle.

Inspection Points (Secure):

- ✓ Check to see that U-Bolts are securely mounted and not damaged.

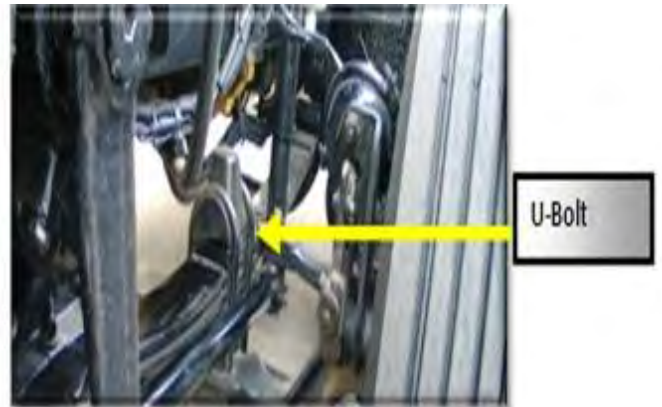

11.5.4 Shock Absorber:

Description: Gas or hydraulic devices that cushion the ride and stabilize vehicle.

Inspection Points (Secure, Leaks):

- ✓ Check to see that the shock absorber is securely mounted.
- ✓ Check to see that the shock absorber is not leaking.

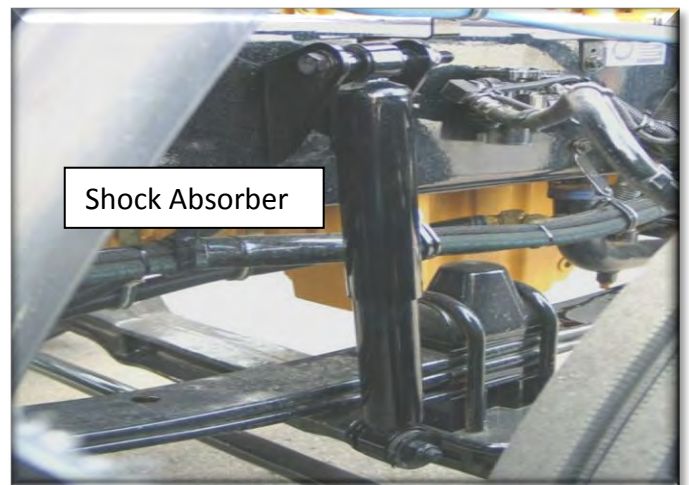

11.6. BRAKE COMPONENTS

11.6.1 Slack Adjuster and Pushrod:

Description: The slack adjuster is the link between the brake chamber or actuator and the foundation brake camshaft. It transforms and multiplies the force developed by the chamber into a torque which applies the brakes via the brake camshaft.

Rationale: If the stroke is too long, it will increase stopping distance or cause vehicle to pull when stopping. Adjustment that is too tight may cause wheel lockup or excessive heat as a result of the brake lining dragging against the drum. This could create a fire hazard.

Inspection Points (Condition, 1 Inch):

- ✓ Check that slack adjuster is securely mounted.
- ✓ Check slack adjuster and pushrod for bent, broken, loose, or missing parts.
- ✓ If brakes were released and when pulled by hand, pushrod should not move more than approximately 1 inch.

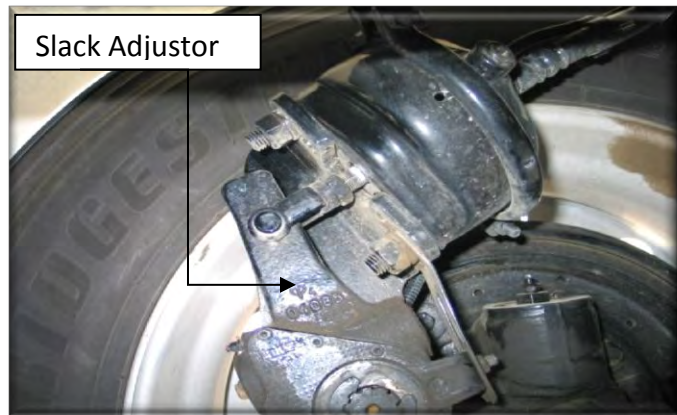

Special Note: The following are two (2) types of slack adjusters found in most air brake systems:

MANUAL SLACK ADJUSTER

Manual slack adjusters are equipped with an adjusting mechanism, providing a means of adjusting for brake lining wear. Slack adjuster models are designated by a number which represents its maximum torque rating (i.e. a type 20 unit is rated for a maximum of 20,000 inch pounds of torque). Slack adjusters are available in various arm configurations, lengths and spline types.



AUTOMATIC SLACK ADJUSTER

Automatic slack adjusters perform the same function as the manual units, except that it automatically adjusts for lining wear. The entire slack adjuster operates as a unit, rotating as a lever with the brake cam shaft as the brakes are applied or released. The most efficient braking action is obtained when the slack adjuster arm travel is minimal; therefore, it is important that brake adjustments are made as often as necessary. The automatic slack adjuster does not require periodic manual adjustment; however, the unit does provide for manual adjustment.



Special Note: The 1 inch test for the brake adjustment is a basic "Rule of Thumb" number to assist the driver in making an educated guess on whether or not his/her brakes may need to be adjusted. The actual stroke adjustment requirement varies for different size chambers (i.e., a type 6 (4 1/2" diameter) chamber's stroke tolerance is 1 1/4" and a type 36 (9" diameter) chamber's stroke tolerance is 2 1/4").

11.6.2 Brake Chamber:

Description: Converts air pressure to mechanical force to operate wheel brakes.

Rationale: Damage may reduce braking force, cause uneven braking, or extended stopping distance.

Inspection Points (Condition, Secure):

- ✓ Check to see that brake chambers are not leaking, cracked or dented, and are mounted securely.
- ✓ Make sure there are no loose or missing clamps.

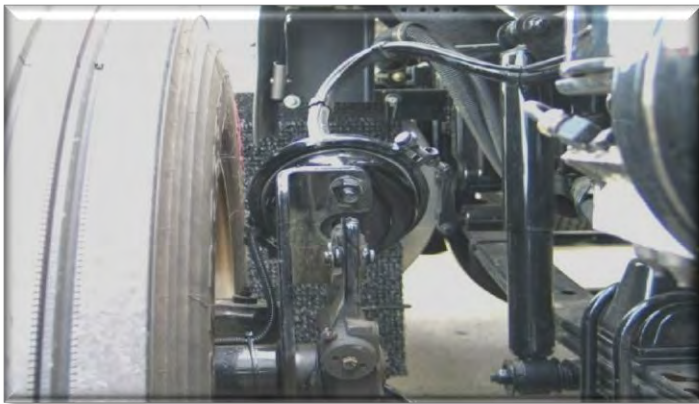

11.6.3 Brake Hoses/Lines:

Description: Carries air or hydraulic fluid to wheel brake assembly.

Rationale: Failure may lead to loss of brake response, or with many brakes, a sudden brake application could result in wheel lockup and loss of control.

Inspection Points (Condition, Secure, Leaks):

- ✓ Check that hoses or lines can supply air or hydraulic fluid to brakes.
- ✓ Check for cracked, worn or frayed hoses, and that all couplings and fittings are secure and not leaking.

Special Note: If electric brakes, check that electric lines are secure and casing is not worn or cracked

11.6.4 Brake Drum or Rotor:

Description: Brake linings, or pads, rub on the inside of the drum or on the rotor to slow the vehicle down.



Brake Drums

Rationale: Cracked drums or rotors may lead to loss of brake response. Worn drums or rotors can cause excessive heat buildup from reduced ability to absorb and dissipate heat or possible "CAM OVER" of S-cam brakes.

Inspection Points (Condition):

- ✓ Check brake drums or rotors for cracks, dents, or holes. Also check for loose or missing bolts.

11.6.5 Brake Linings or Pads:

Description: The friction material that wears against the inside of the brake drum, to slow and stop the truck is called the lining; its effectiveness in doing this depends on the brake surface area, surface temperature and the brake lining material itself.

Rationale: Worn linings or pads can cause excessive heat buildup from reduced ability to absorb and dissipate heat.



Inspection Points (Condition, not worn thin):

- ✓ Check that brake lining or pads (where visible) have an adequate amount of lining remaining and are not worn dangerously thin.

- ✓ Check condition of linings or pads for cracks and damage.
- ✓ Learn what the minimum acceptable pad or lining thickness is for your vehicle.

11.6.6 Fluid or Grease on Drums / Linings or Rotors / Pads:

Description: Fluid/grease from leaking axle seals or wheel cylinders on brake drums/rotors and linings and pads.

Rationale: When an axle hub seal or hydraulic wheel cylinder leaks, it results in oil or brake fluid being flung over the braking surface of the linings. Since the friction material is porous, it will absorb the oil, and the oil will act as a lubricant, thus a lower friction rating will occur. This will put more work on the other brakes since the one soaked in oil will not perform as well. If this occurs, the friction material must be replaced. Oil soaked linings and pads can also catch fire due to the heat generated by friction.

Inspection Points:

- ✓ Check brake drums/rotors and linings/pads for contaminants such as grease, oil, etc.



11.7 WHEELS & TIRES

11.7.1 Tires:

Description: Road wheel tires.

Rationale: Low inflation or lack of tread increases the effect of hydroplaning, reduces cornering ability, and increases the chance of blowout from excessive heat buildup due to increased flexing of the tire. Stopping distance is extended from poor contact with the road surface.

Over inflation increases the chance of tread separation and tire failure. Cuts and bruises may cause tire failure, blowout, and sudden loss of control.

Inspection Points (Condition, 4/32" Tread Depth, Inflation):

- ✓ **Tread depth:** Check for minimum tread depth of 4/32" on the steering axle tires.
- ✓ **Tire condition:** Check that tread is evenly worn and look for cuts or other damage to tread or sidewalls. Also, make sure that valve caps and stem are not missing, broken or damaged.



- ✓ **Tire inflation:** Check for proper inflation by using a tire gauge.

NOTE: You will not get credit on the test for "kicking the tires" to check for proper inflation. Proper inflation can only be determined with an accurate truck tire gauge.

Special Note: Frequent checks of your tires will pay you dividends on the road. Finding a low tire in time might prevent a blow out in the middle of nowhere! Many drivers carry inflation hoses that can be hooked up to air compressor lines to inflate a low tire until it can be repaired.

You can quickly get a good idea of a tire's approximate level of inflation by walking around the truck and trailer and 'bumping' the tire treads with a "tire billy", hammer, mallet, ratchet bar, or some other tool.

Tire Billy Clubs



11.7.2 Rims:

Description: Tires are mounted on metal rims.

Rationale: Damaged rims can result in loss of a tire from the rim; loss of a wheel from an axle; loss of air pressure in a tire, or a wheel rolling off a rim due to damage to flange. A damaged wheel can result in loss of vehicle control, leading to an accident.

Inspection Points (Condition, Welds, Bent Flange):

- ✓ Check for damaged or bent rims and bent flange.
- ✓ Rims should not have welding repairs.
- ✓ Check for rust trails that may indicate the rim is loose on the wheel.

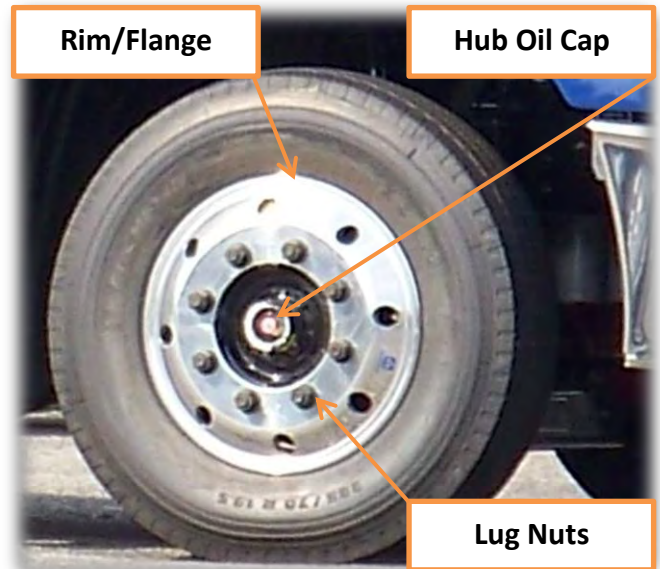

11.7.3 Lug Nuts:

Description: Holds wheel to axle.

Rationale: Loose or missing lug nuts could result in the loss of a wheel.

Inspection Points (All Present, Secure, No Rust Trails):

- ✓ Check that all lug nuts are present.
- ✓ Check that lugs are not loose (rust trails around nuts or black streaks on aluminum wheels).
- ✓ Check that there are no cracks radiating from lug bolt holes or distortion of the bolt holes.

11.7.4 Hub Oil/Axle Seals:

Description: Seals for axle/wheel assembly lubrication.

Rationale: Bearing seizure and uneven braking may result from lack of lubrication.

Inspection Points (Condition, Leaks):

- ✓ Check to see that hub oil/grease seals are not leaking, and if a sight glass is present, that the oil level is adequate. Be sure to look **INSIDE** the tire to see if the seal is leaking on the back side of the wheel.
- ✓ Check to see hub oil cap is not cracked or damaged.

11.8 DRIVER/FUEL AREA

11.8.1 Driver's Door:

Description: Driver entry/exit door.

Inspection Points (Condition, Operation):

- ✓ Check to see that door is not damaged and opens and closes properly.
- ✓ Check to see hinges are secure with seals intact.

11.8.2 Mirrors:

Description: All mirrors for viewing traffic to the sides and behind.

Rationale: Mirrors provide visibility to the sides, rear, and inside the vehicle. The driver must be able to see other traffic and especially in the blind areas of the vehicle.

Inspection Points (Condition, Secure):

- ✓ Check that all internal and external mirrors and mirror brackets are securely mounted, not damaged, and free of excessive dirt.



11.8.3 Fuel Tank:



Description: Tank(s) that hold fuel.



Rationale: Leaks are a fire hazard and can cause driving hazards to other traffic. Fuel on pavement can be very slippery.

Inspection Points (Secure, Cap Tight, Leaks):

- ✓ Check that fuel tank(s) are secure.
- ✓ Check that fuel cap(s) are tight.
- ✓ Check for leaks from fuel tank(s) and fuel cap(s).

11.8.4 Battery/Box:

Description: A battery supplies electric energy to a vehicle for starting, lighting and ignition.

Inspection Points (Secure, Connection & Cell Caps, Condition):

- ✓ Check to see that battery(s) is secure.
- ✓ Check to see that battery box door is secure
- ✓ Check to see that connections are tight and all cell caps (if any) are present.
- ✓ Check to see that battery connections are not excessively corroded.



11.8.5 Catwalk:

Description: Platform at rear of cab for the driver to stand on when connecting or disconnecting trailer lines.

Rationale: If not secure, the platform could move or shift causing injury to the driver, or it could fall off and hit other traffic.



Inspection Points (Condition, Secure):

- ✓ Check that catwalk is solid, securely bolted to the tractor frame, clear of loose objects and not severely damaged.

11.8.6 Steps:

Description: Steps to enter the vehicle.

Inspection Points (Condition, Secure):

- ✓ Check to see entry steps are solid, securely mounted to the vehicle, clear of loose objects, and not severely damage.



11.8.7 Truck Header Board:

Description: Prevents cargo from shifting forward and injuring driver when the vehicle abruptly stops. Also known as a "Headache Rack."

Rationale: If not secure, may let cargo shift forward causing injury to the driver or damage to the equipment.



Inspection Points (Condition, Secure):

- ✓ If equipped, check the header board to see that it is secure, free of damage, and strong enough to contain cargo.

11.9 SUSPENSION: REAR AXLE (TRUCK or TRAILER)

11.9.1 Springs:

Description: Leaf or coil springs for dampening wheel vibration forces created by rolling over road surface.

Rationale: Damaged or missing leaves may lead to loss of control or rollover if the vehicle falls on the frame or on a tire. Shifted springs may strike a tire causing a blowout or interference with steering.

Inspection Points (Condition, Secure):

- ✓ Look for missing, shifted, cracked, or broken leaf springs.
- ✓ Look for broken or distorted coil springs.



Springs

11.9.2 Air Bags:

Description: Air Bags act as springs or accompany them as a part of the vehicle or trailer suspension.

Rationale: Like springs, air bags dampen the wheel vibration caused by rolling over the road surface. If they become damaged or leak, the weight of the load can shift causing a loss of control or allow the frame to come in contact with the tire causing a blowout.

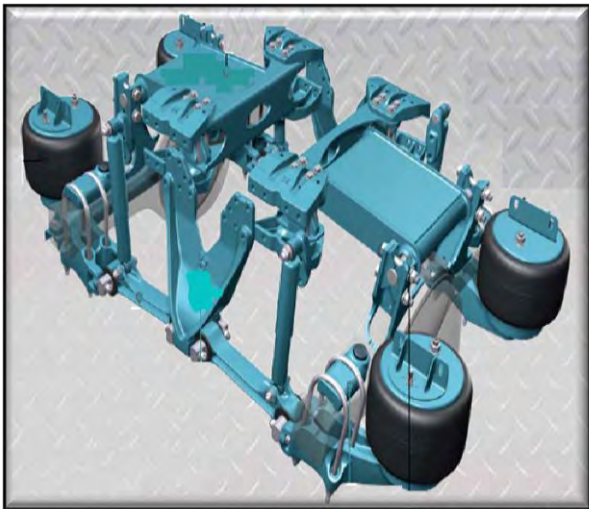

Inspection Points (Condition, Leaks):

- ✓ Check air-ride suspension for damage and leaks.

- ✓ Check air bag mounts (bolts) are in place and not damaged.

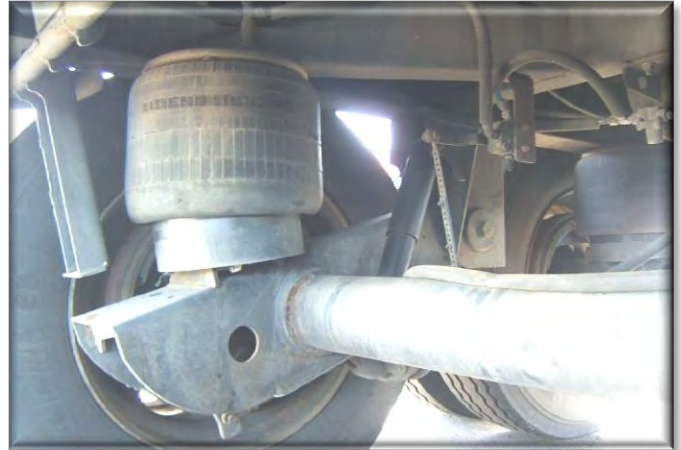

11.9.3 Torque Arm:

Description: The torque arm is a suspension member intended to control wheel motion in the longitudinal (fore-aft) plane.

The link is connected (with a rubber or solid bushing) on one end to the wheel carrier or axle, on the other to the chassis of the vehicle.

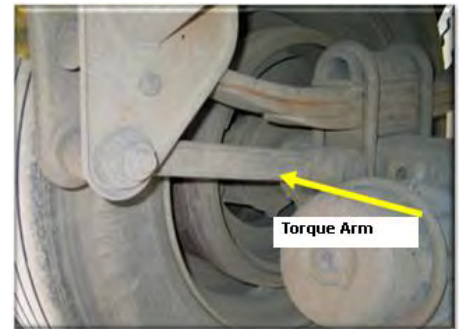

Torque Arms typically are mounted ahead of the wheel. In that position, they resist dive under braking forces and wheel hop under acceleration. The torque arm is also a means for adjusting the axle and keeps it from shifting and moving. Other common names are torsion bars, torque springs.

Inspection Points (Condition, Secure):

- ✓ Check that the torque arm is not bent or damaged
- ✓ Check for worn or missing bushings.
- ✓ Check to see the torque arm is securely mounted.

11.9.4 Spring Mounts:

Description: The spring mount attaches the springs to the frame of the vehicle.

Rationale: Broken spring mounts can cause the springs to shift resulting in loss of vehicle control or rollover.

Inspection Points (Condition, Secure):

- ✓ Check for cracked or broken spring hangers
- ✓ Check to see that spring hangers are securely mounted to the vehicle/trailer frame.



11.9.5 U-Bolts:

Description: U-shaped bolts and mounting bolts used for attaching suspension assembly to the axle.

Rationale: Loose or broken U-bolts may lead to loss of vehicle control or rollover.

Inspection Points (Secure):

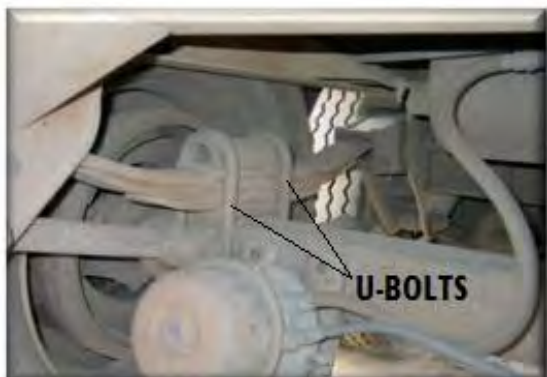

- ✓ Check for broken, missing, or loose U-bolts.

11.9.6 Shock Absorber:

Description: Gas or hydraulic devices that cushion and stabilize vehicle/trailer ride.

Inspection Points (Secure, Leaks):

- ✓ Check to see that shocks are secure and not leaking.



11.10 BRAKE COMPONENTS

11.10.1 Slack Adjuster and Pushrod:

Description: A lever that connects the brake chamber pushrod with the foundation brake camshaft. It provides torque to rotate the brake camshaft when the brake pedal is depressed. It also provides a means of adjusting clearance between brake shoes and drum to compensate for lining wear.



Rationale: If the stroke is too long, it will increase stopping distance or cause vehicle to pull when stopping. Adjustment that is too tight may cause wheel lockup or excessive heat as a result of the brake lining dragging against drum. This could create a fire hazard.

Inspection Points (Condition, 90° or 1" Free Play):

- ✓ Check that slack adjuster is securely mounted.
- ✓ Check slack adjuster and pushrod for bent, broken, loose, or missing parts.
- ✓ If the brakes are released and you pull the slack adjuster by hand, the pushrod slack should not exceed approximately one (1) inch, or with the brakes set, the angle formed between the pushrod and the slack adjuster should not exceed 90°.

Special Note: The 1 inch test for the brake adjustment is a basic "Rule of Thumb" number to assist the driver in making an educated guess on whether or not his/her brakes may need to be adjusted. The actual stroke adjustment requirement varies for different size chambers (i.e., a type 6 (4 ½" diameter) chamber's stroke tolerance is 1 ¼" and a type 36 (9" diameter) chamber's stroke tolerance is 2 ¼").

The 90° angle is also a "Rule-of Thumb" indication that depends on how the pushrod and slack adjuster were adjusted at the time of installation/replacement by a mechanic. It is still a good way to see at a glance if your brakes might need adjustment (See figure.11.1)

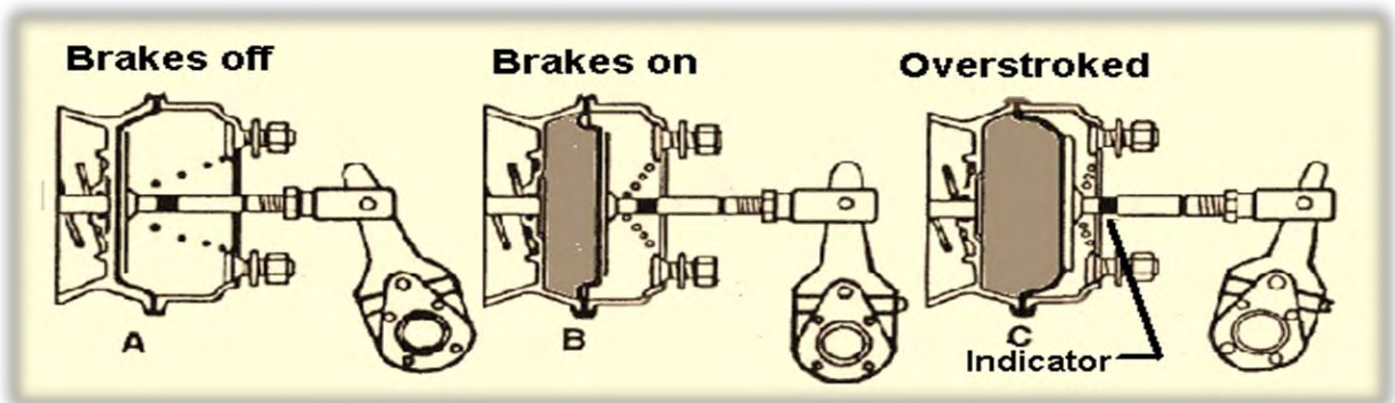

Figure 11.1 - Air Brake Adjustment

Air brakes should be adjusted in the shop with the wheels off the ground according to the manufacturer's instructions, but if you're on the road and you're looking at several miles of a 6% downgrade, here is what you can do if you're not sure your brakes are right:

See how far the adjusting arm will move with air pressure (80 psi or above) or by manually turning the arm with your hand or a pry bar (brakes released). It should not go beyond the 90° point illustrated in figure B. You may or may not have the visual over-stroke indicator on the pushrod that is shown here. At the very least, adjust the slack until the stroke does not go beyond the 90° mark. The adjusting arms should all be at the same angle with the same pressure applied. Don't over tighten. Bang the brake drum lightly with a wrench or hammer with the pressure off. The drum should ring hollow if the shoes are clear of the drum. A dull thud means you still have lining-drum contact and you should back off the adjustment. When you bring

the free play down to about 3/8", the stroke should be well short of the 90° point.

11.10.2 Brake Chamber:

Description: Transforms air pressure into mechanical force to operate wheel brakes.



Rationale: Damage may reduce braking force, cause uneven braking, or extended stopping distance.

Inspection Points (Condition, Secure):

- ✓ Check to see that brake chambers are not leaking, cracked or dented, and are mounted securely.
- ✓ Make sure there are no loose or missing clamps.

11.10.3 Brake Hoses/Lines:

Description: Carries air or hydraulic fluid to wheel brake assembly.

Rationale: Failure may lead to loss of brake response, or with many brakes, a sudden brake application could result in wheel lockup and loss of control.



Inspection Points (Condition, Secure, Leaks):

- ✓ Check that hoses or lines can supply air or hydraulic fluid to brakes.
- ✓ Check for cracked, worn or frayed hoses, and that all couplings and fittings are secure and not leaking.

11.10.4 Brake Drum or Rotor:

Description: Located on the vehicle/trailer(s) axles. Wheels are bolted to the drums. The braking mechanism is inside the drum. To stop, the brake shoes are pushed against the inside of the drum. The **disc brake** or **disk brake** is a device for slowing or stopping the rotation of a wheel. A *rotor*, usually made of cast iron or ceramic composites (including carbon, kevlar and silica), is connected to the wheel and/or the axle. To stop the wheel, friction material in the form of

brake pads (mounted on a device called a **brake caliper**) is forced mechanically, hydraulically, pneumatically or electromagnetically against both sides of the disc. Friction causes the disc and attached wheel to slow or stop.



Rationale: Cracked drums may lead to loss of brake response. Worn linings or drums can cause excessive heat buildup from reduced ability to absorb and dissipate heat or possible "CAM OVER" of S-cam brakes. Discs are usually damaged in one of four ways: warping, scarring, cracking, or excessive rusting.

Inspection Points (Condition):

- ✓ Check brake drums or rotors for cracks, dents, or holes. Also checks for loose or missing bolts.



11.10.5 Linings or Pads:

Description: Brake shoe friction linings that rub against the brake drums, or disc brake pads that rub against a rotor to stop or slow a vehicle/trailer(s).

11.11 WHEELS/ TIRES (REAR AXLE)

11.11.1 Tires:

Description: Road wheel tires.

Rationale: Low inflation or lack of tread increases the effect of hydroplaning, reduces cornering ability, and increases the chance of blowout from excessive heat buildup due to increased flexing of the tire. Stopping distance is extended from poor contact with the road surface.

Over inflation increases the chance of tread separation and tire failure. Cuts and bruises may cause tire failure, blowout, and sudden loss of control.

Inspection Points (Condition, 2/32" Tread Depth, Inflation):

- ✓ **Tread depth:** Check for minimum tread depth of 2/32".



- ✓ **Tire condition:** Check that tread is evenly worn and look for cuts or other damage to tread or sidewalls. Also, make sure that valve caps and stem are not missing, broken, or damaged.

- ✓ **Tire Inflation:** Check for proper inflation by using a tire gauge



- ✓ **Note:** You will not be given credit for kicking the tires to check for proper inflation.

Rationale: Worn or damaged brake linings or pads reduce the braking efficiency of the vehicle and/or trailer(s). They can also cause excessive heat buildup from the reduced ability to absorb and dissipate heat and could result in the total loss of brakes.

Inspection Points (Condition, Lining Thickness):

- ✓ **Check that brake linings or disk pads (where visible) are not worn dangerously thin. Know the minimum thickness for disk pads or linings for your vehicle.**
- ✓ **Check that brake linings or disk pads are not cracked or damaged.**



11.10.6 Fluid/Grease on Brake Components:

Description: Fluid/grease from leaking axle seals or wheel cylinders on brake drums/rotors and linings and pads.

Rationale: When an axle hub seal or hydraulic wheel cylinder leaks, it results in oil or brake fluid being flung over the braking surface of the linings. Since the friction material is porous, it will absorb the oil, and the oil will act as a lubricant, thus a lower friction rating will occur. This will put more work on the other brakes since the one soaked in oil will not perform as well. If this occurs, the friction material must be replaced. Oil soaked linings and pads can also catch fire due to the heat generated by friction.

Inspection Points:

- ✓ **Check brake drums/rotors and linings/pads for contaminants such as grease, oil, etc.**

Special Note: Measuring Tire Tread Depth with a Coin

U.S. coins can be substituted for a tire tread depth gauge as tires wear to the critical final few 32nds of an inch of their remaining tread depth.

Place a penny into several tread grooves across the tire. If part of Lincoln's head is always covered by the tread, you have more than 2/32" of tread depth remaining.



2/32" remaining tread depth

Place a quarter into several tread grooves across the tire. If part of Washington's head is always covered by the tread, you have more than 4/32" of tread depth remaining.



4/32" remaining tread depth

11.11.2 Rims:

Description: Rims retain tires on wheels. Damaged rims can result in a loss of a tire from the rim, loss of a wheel from an axle, loss of air pressure in a tire or a wheel rolling off a rim due to damage to the flange. A damaged wheel can result in loss of vehicle control, which may result in an accident or other hazardous driving situation.

Inspection Points (Condition, Welds, Bent Flange):

- ✓ Check for damaged or bent rims and bent flange.
- ✓ Rims should not have welding repairs.
- ✓ Check for rust trails that may indicate rim is loose on wheel.

11.11.3 Lug Nuts:

Description: Holds wheel to axle.

Rationale: Loose or missing lug nuts could result in the loss of a wheel.



Inspection Points (All Present, Secure, No Rust Trails):

- ✓ Check that all lug nuts are present.
- ✓ Check that lugs are not loose (rust trails around nuts).
- ✓ Check that there are no cracks radiating from lug bolt holes or distortion of the bolt holes.

11.11.4 Hub Oil Seal:

Description: Seals for axle/wheel assembly lubrication.

Rationale: Bearing seizure and uneven braking may result from lack of lubrication.



Inspection Points (Condition, Leaks):

- ✓ Check to see that hub oil/grease seals are not leaking, and if a sight glass is present, that the oil level is adequate.
- ✓ Check to see hub cap is not cracked or damaged.



11.11.5 Spacers or Space:

Description: Axle collar between dual wheels to keep wheels evenly separated.

Inspection Points:

- ✓ Check to see that spacers are not bent, damaged, or rusted through.
- ✓ Check to see that spacers should be evenly centered with dual wheels and tires evenly separated.
- ✓ Check for debris between the tires and make sure they are not touching.



11.12 IN-CAB CHECK

11.12.1 Safety Belt:

Description: Safety Belt

Rationale: Safety belt must be available and in usable condition.

Inspection Points:

- ✓ Check for properly secured, mounted, and adjusted safety belt. Safety belt should not be ripped or frayed.



Special Note: You must wear your safety belt during the road test or you will automatically fail the test.

11.12.2 Emergency Equipment:

Description: Required emergency equipment.

Rationale: Emergency equipment must be available and in usable condition.



Inspection Points (Fire Extinguisher, Reflective Triangles, Fuses or Circuit Breakers):



- ✓ Check for three red reflective triangles.
- ✓ Check for a properly charged, rated (5 B:C or better) and labeled fire extinguisher(s) securely mounted in a readily accessible location.
- ✓ Check for spare electrical fuses (if used) or identify the location of the circuit breakers.

11.12.3 Mirrors:

Description: Side mirrors for viewing traffic to the sides and rear of the vehicle.



Rationale: Mirrors provide visibility to the sides and rear of the vehicle. The driver must be able to see the traffic around him/her to safely operate the vehicle.

Inspection Points (Adjust):

- ✓ Check for proper adjustment.
- ✓ Check that visibility is not impaired due to dirty mirrors.

11.12.4 Windshield:

Description: Windshield.

Rationale: Cracks, stickers, glare, or dirt can cause driver to lose sight of other traffic or changes in road conditions.



Inspection Points (Condition):

- ✓ Inspect windshield for cracks, dirt, illegal stickers, or other obstructions to seeing clearly.
- ✓ Check windshield to make sure it is clean

11.13 ENGINE START

SAFE START:

- Depress clutch.



- Place gearshift lever in neutral
- Or Park, for automatic transmissions



- Start engine, then release clutch slowly.

11.13.1 ABS Dashboard Indicator Light:

Description: Warning light on the instrument panel that remains illuminated if a fault develops in any part of the ABS. If a fault occurs in the system, the ABS warning light will come on, and the ABS will be disabled until the problem is rectified.



ABS Warning Light

Rationale: Malfunctioning ABS can impact a driver's performance when

reacting to an emergency situation.

Inspection Points:

- ✓ When starting the engine, check the dashboard to ensure the ABS lighting indicator illuminates and then promptly turns off. If the ABS lighting indicator remains illuminated, the ABS is not functioning properly and needs to be serviced

11.13.2 Oil Pressure Gauge:

Description: Ensures that engine oil pressure is adequate.

Rationale: The oil pressure check will ensure that the engine has sufficient lubrication to prevent engine failure, seizure or breakdown



Inspection Points:

- ✓ With the key in the “on” position and the engine running, check that the oil pressure is building to “normal.”
- ✓ Check to see that the gauge shows increasing or “normal” oil pressure or warning light goes off.

11.13.3 Water Temperature Gauge:

Description: Measures water temperature in engine cooling system.

Inspection Points:

- ✓ With key on and engine running ensure the temperature gauge is operational.
- ✓ Check to see that the temperature should begin to climb to the “normal” operating range or temperature light should go off.

11.13.4 Ammeter/Voltmeter Gauge:

Description: Shows if generator or alternator is functioning.

Inspection Points:

- ✓ With engine running and key in the “on” position, check to see that gauge(s) show alternator or generator is charging or warning light is “off.” Needle will jump and flutter, then indicate charge.

11.13.5 Air Gauge(s):

Description: Informs the driver of the amount of air pressure in the air brake system.

Inspection Points:

- ✓ Check to see that the air gauge is working properly and that the air compressor builds the air pressure to governor cut-out at about 100 -125 psi or as specified by the manufacturer.

11.13.6 Heater/Defroster:

Description: Heats cab and/or passenger compartment and prevents frost or condensation from forming on windshield.



Rationale: The defroster improves visibility, especially during cold weather.

Inspection Points (Operation):

- ✓ Check to see if heater and defroster are operational.

11.13.7 Wiper Blades:

Description: Wipers keep windshield clear during adverse weather conditions.

Rationale: Wipers improve visibility during adverse weather conditions. Worn wiper blades have an adverse effect and decrease visibility.



Inspection Points (Condition, Operation):

- ✓ Checks to see that wiper arms and blades are secure, not damaged, and operate smoothly.

11.13.8 Windshield Washer:

Description: Windshield washers allow the driver to clean the windows of dirt and debris to increase visibility.

Inspection Points (Operation):

- ✓ Check for windshield washer fluid and that the windshield washers are operational.



11.13.9 Horn(s):

Description: Air and/or electric horns for warning



other drivers or pedestrians.

Rationale: The horn is a device that must function properly in order to warn other traffic of your presence (i.e., cars, pedestrians, and bicyclists) of vehicle presence.

Inspection Points (Operation):

- ✓ Check to see that air horn and/or electric horn(s) work.



11.13.10 In-Dash Lighting Indicators:

Description: Dashboard indicator light for signals, flashers, and headlight high beam.

Inspection Points:

- ✓ Check to see that (dash) indicators for turn signals, flashers, and headlight high beams illuminate when corresponding lights are turned on.

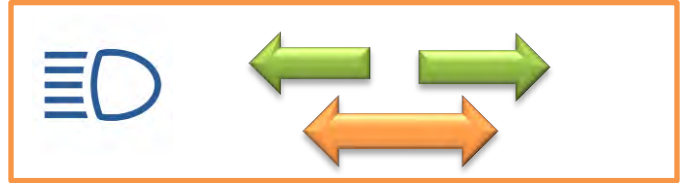

11.14 BRAKE TEST

11.14.1 Parking Brake(s):

Rationale: The truck/tractor and trailer parking brakes must function when a vehicle is parked, especially when on a grade. A vehicle allowed to roll could cause damage or injury to other vehicles, pedestrians, or motorists. A combination vehicle will be placed "Out of Service" if either parking brake system (truck/tractor and trailer) cannot independently stop the vehicle from moving.

On Combination Air Brake equipped vehicles, both brake systems must be checked separately to receive credit for the component.

If either one does not hold the vehicle during the test, the vehicle is "Out of Service" and cannot be used for the test until repairs have been made.

11.14.2 Service Brake:

Description: The service brake system applies and releases the brakes on a vehicle and/or trailer(s) when the driver pushes the brake pedal. The system can be air, electric, hydraulic or a combination of systems (i.e., air over hydraulic).

**Correct Brake checks are a must!
Detailed instructions follow:**

STEP ONE (ALL VEHICLES) PARKING BRAKE TEST:

Straight Truck and Buses with Air Brakes: With the parking brake engaged check that parking brake will hold vehicle by **gently** trying to pull forward with parking brake on.



Combination Vehicles with Air Brakes: Step One:

With the truck/tractor parking brake engaged and the trailer brake (Tractor Protection Valve) released, check that the truck/tractor parking brake will hold vehicle by **gently** trying to pull forward.



Combination Vehicles with Air Brakes: Step Two:

With the trailer brake (Tractor Protection Valve) engaged and the truck/tractor parking brake released, check that the trailer brake will hold the vehicle by **gently** trying to pull forward.



HYDRAULIC BRAKE VEHICLES:

All Vehicles: With the parking brake engaged check that parking brake will hold vehicle by **gently** trying to pull forward with parking brake on.



STEP TWO (ALL VEHICLES) Service Brake Test

Release the parking brake
(or brakes)

(air or hydraulic)



Pull forward at
approximately 5 mph, and
apply service brake.
Check to see that brakes
are working properly and
to see if the vehicle pulls
to one side or the other.



Special Note: The Trolley Valve (Johnson Bar) is a modulating valve used to apply the spring brakes on a trailer gradually. The valve is activated by pulling down on a spring loaded handle located on the steering column or dashboard of some trucks/tractors. It is spring loaded so the driver will have a feel for the braking action. The more he/she moves the control lever, the harder the spring brakes come on. The system allows drivers to activate and control the spring brakes if the service brakes fail. Although not an item to be tested, drivers should test the system by; releasing the parking brake(s); pulling the Trolley Valve handle all the way down, and gently pulling against the brake to make sure it will hold the vehicle.



STEP THREE (AIR BRAKE VEHICLES)

11.14.3 Air Brake System Check:

Description: Procedures to be followed in checking the air brake system.

Rationale: Air brake safety devices vary; however, this procedure is designed to make certain that a given device is operating correctly as air pressure drops from “normal” to “low air” conditions.

Inspection Points (Leak Check, Low Air Alarm, Tractor Protection Valve):

WARNING:
 Failure to perform all three components of the air brake check correctly will result in an automatic failure of the vehicle inspection test. Air brake safety devices vary. However, this procedure is designed to see that any safety device operates correctly as air pressure drops from normal to a low air condition.

Note: As you conduct The Air Brake System Checks, you must describe to the test examiner what you are checking for and what the expected results will be. You must know the critical p.s.i. numbers. The proper procedures for inspecting the air brake system are as follows:

Air Leak Check: Part One of Three

With the engine running, build the air pressure up to the governed cut-out of 100 to 125 psi (operational level).



Shut the engine off and turn the ignition key back to the “ON” position



Release the Tractor Protection Valve and Parking brakes by pushing both valves in * *see note below*



Fully apply the foot brake and hold it steady for one (1) minute.



Check the air gauge to see if the air pressure drops.
 Air drop cannot exceed:



- Single Vehicle:**
- 3 pounds in 1 minute.
- Combination Vehicle:**
- 4 pounds in 1 minute.

Special Note: If the loss of air exceeds the above amounts, there is a defect somewhere in the system.

*** For safety purposes, in areas where an incline is present, you must use wheel chocks during the air brake system check.**

Low Air Alarm Check: Part two of three

Make sure the engine is off and the ignition key is in the "ON" position.



Fan (pump) the brake pedal to reduce the air pressure in the system.



The low-air warning devices (buzzer, light or flag) should activate before air pressure drops below approximately 60 psi).



- 60 p.s.i. +/- low air alarm should come on

Note: There is a simplified brake check practice sheet in the back of this manual.

Cut it out and use it to help you study and memorize the brake check procedures



Tractor Protection Valve/Spring Brake Check: Part three of three

Continue to fan off the air pressure. You must tell the examiner that the tractor protection valve and parking brake valve should close (pop out) when the pressure in the system drops between 20 and 45 psi. >On other combination vehicle types and single vehicle types, the parking brake valve should close (pop out).



- 20-45 PSI, TPV Valve should pop out



Special Note: Air brake check procedures vary from vehicle to vehicle and different drivers may have learned different procedures; however, all procedures are designed to confirm that the correct safety devices operate at the appropriate times as the air pressure drops from "normal" to "very low."

Not all valves will pop out on every vehicle, but an audible discharge of air should be recognizable. The "Air Brake System Check" must be done correctly and in order (Leak Down, Low Air Alarm and Tractor Protection Valve) to pass the skills test.

If you forget to turn the key "on", but recognize your mistake before you complete the check (valve pops), you will be permitted to start the procedure over.

WHEN THE VALVE "POPS" THE TEST IS OVER.

WARNING:

Failure to perform the hydraulic brake check correctly will result in an automatic failure of the vehicle inspection test.



Driver should check the parking brake and service brake as well as the procedure below:

STEP THREE (HYDRAULIC BRAKE VEHICLES)

11.14.4 Hydraulic Brake Check:

Description: Procedure to be followed to check hydraulic brakes.

Inspection Points (3 X 5, Reserve System):

<p>Pump the brake pedal 3 times and hold it down for 5 seconds. The brake pedal should not move (depress) during the 5 seconds.</p>	
<p>If equipped with a hydraulic brake reserve (backup) system, with the key off, depress the brake pedal and listen for the sound of the reserve system electric motor.</p>	

COUPLING SYSTEM

11.15 FIFTH WHEEL

11.15.1 Air/Electric Lines:

Description: Carry air and electricity from power unit to trailer(s).

Rationale: **Air-** The loss of air to the trailer will result in a partial or total loss of braking to the towed unit. A low air condition will cause sudden application of the trailer's spring brakes, which may result in loss of control. **Electric Lines-** Damaged lines may result in loss of the vehicle's ability to communicate its maneuvers to other drivers (no brake, turn, or stop lights). Not being seen by other traffic at night is a serious traffic hazard.



Inspection Points (Secure, Condition, Leaks):

- ✓ Check that air hoses, electrical lines and electrical line insulation to ensure they are not cut, cracked, chafed, spliced, taped, or worn (steel braid/electrical conductor should not show through) from the power unit.
- ✓ Check to see air and electrical lines are not tangled, crimped or pinched or being dragged against tractor parts (i.e., catwalk).

11.15.2 Fifth Wheel Mounting Bolts:

Description: Bolts that hold the fifth wheel to the tractor frame.

Rationale: Loose or missing bolts may cause movement between the frame and the coupling assembly resulting in handling and stability problems in turn and curves. Loose bolts could break off, resulting in loss of the trailer.

Inspection Points (Condition, Secure):

- ✓ Check for loose and/or missing brackets, clamps, bolts or nuts.
- ✓ Check that both fifth wheel and sliding mounting appear solidly attached in place.



11.15.3 Sliding Fifth Wheel Locking Pins:

Description: Holds the sliding fifth wheel in fixed position along slider rails.



Rationale: If not locked, the trailer could move during travel and result in loss of trailer.

Inspection Points (Secure):

- ✓ If equipped, look for loose or missing pins in the slide mechanism of the sliding fifth wheel. If air powered, check for leaks.
- ✓ Make sure locking pins are fully engaged.
- ✓ Check that the fifth wheel is positioned properly so the tractor frame will clear the landing gear and the trailer won't hit the cab during turns.

11.15.4 Release Arm:

Description: Releases fifth wheel locking jaws so that the trailer can be uncoupled.



Rationale: The release arm must be in the **engaged** position with locking jaws completely closed around the kingpin. This will prevent loss of the trailer during travel.

Inspection Points (Locked):

- ✓ Check that the release arm is secure and all the way in (engaged position).
- ✓ If equipped with safety latch, check that the release arm is in the engaged position and the safety latch is in place.

11.15.5 Trailer Apron:

Description: The metal plate that attaches to the trailer that provides the surface for resting the trailer on the fifth wheel.



Rationale: If the apron is damaged, the tractor/trailer connection is unsecure and could result in the loss of the trailer or other equipment damage.

Inspection Points (Condition):

- ✓ Check to make sure the visible part of the apron is not bent, cracked, or broken.

11.15.6 Trailer Apron – Fifth Wheel Plate Gap:

Description: When coupled, the distance between the fifth wheel surface and the trailer apron.



Rationale: If there is a gap between the face of the fifth wheel (skid plate) and the metal plate (apron) of the trailer, the trailer is not coupled correctly and could result in the loss of the trailer during travel.

Inspection Points (Zero Gap):

- ✓ Check that the trailer is lying flat on the fifth wheel skid plate (no gap).

11.15.7 Fifth Wheel Platform (Skid Plate):

Description: Plate on which the trailer rests and secures the trailer kingpin.



Rationale: Faulty skid plate and improper connection with the tractor and fifth wheel can result in handling problems, rollover or separation of the tractor and semi-trailer.

Inspection Points (Condition):

- ✓ Check fifth wheel skid plate for proper lubrication.
- ✓ Check to see that there are no cracks or damage to the platform structure.

11.15.8 Fifth Wheel Locking Jaws:

Description: Locking jaws maintain a secure connection around the kingpin and the connection to the trailer.

Rationale: The trailer could uncouple during travel if the locking mechanisms is not secured.



Inspection Points (Condition, Secure):

- ✓ Check that fifth wheel locking jaws or lever are secured around the kingpin
- ✓ Check to see that there is no visible damage to the locking jaws.

11.15.9 Trailer Kingpin:

Description: Pin that attaches trailer to tractor.

Rationale: Wear or damage to the kingpin can result in loss of trailer.



Inspection Points (Condition):

- ✓ Check to see the kingpin is not bent or damaged.

11.16 OTHER COUPLING SYSTEMS

11.16.1 Air/Electric Lines:

Description: Air supply hoses and/or electrical lines connecting truck to trailer.

Inspection Points (Secure, Condition, Leaks):

- ✓ Check to see that hoses and lines are not cut, cracked, chafed, worn, spliced or taped.
- ✓ Check to see that no electrical conductor or steel braid is showing through.
- ✓ Listen for audible air leaks
- ✓ Make sure air and electrical lines are not tangled, crimped, pinched, or being dragged against truck or trailer parts.
- ✓ Check that electric trailer brake lines are not missing, worn or damaged.

11.16.2 Coupling/Mounting bolts:

Description: Nuts, bolts or other components attaching the connector components on both the truck and trailer.

Inspection Points:

- ✓ Check to see that there are no loose, missing, or broken mounting brackets, clamps, bolts or nuts.

11.16.3 Locking Mechanism:

Description: The locking system on a ball hitch would be the lock that keeps the hitch locked over the ball. On a pintle hook, the locking system would be the part that locks the drawbar eye into the pintle hook.



Inspection Points:

- ✓ Check to see that the locking mechanism is locked securely.
- ✓ Check to see that there are no loose or missing components.

11.16.4 Hitch/Drawbar & Eye:

Description: Trailer component attaching the truck to the trailer.

Inspection Points:

- ✓ Check to see that there are no cracks in attachment welds or drawbar.
- ✓ Check eye for welds or excessive wear.



11.16.5 Safety Chains/Cables:

Description: Chains or cables attaching trailer to the truck to prevent a run-a-way.

Inspection Points (Condition, Secure):

- ✓ Check to see that safety cables or chains are secure.
- ✓ Check to see that cables or chains are free of damage, kinks, and excessive slack.

11.16.6 Breakaway Battery Box/Cable:

Description: Battery located on electric brake trailers to prevent the locking of electric brakes unless the trailer becomes un-attached from the truck.

Inspection Points

- ✓ Wherever located, check to see that the battery (s) is secure.
- ✓ Check to see if connections are tight
- ✓ Make sure cell caps (if any) are present.
- ✓ Check battery connections for excessive corrosion.
- ✓ Check to see that the battery box is secure.
- ✓ Check battery cables to see if they are secure and free of damage, kinks and excessive slack.
- ✓ Check to see that the battery is charged.



11.17 TRAILER COMPONENTS- FRONT

11.17.1 Air / Electric Lines :

Description: Connects air supply and electrical power from the truck to the trailer.

Inspection Points (Secure, Condition, Leaks):

- ✓ Check that trailer air lines and connectors are sealed, in good condition and not leaking.

- ✓ Check fittings out of trailer.
- ✓ Check all connections from truck and trailer.
- ✓ Check that glad hands are locked in place and free of damage.
- ✓ Check that trailer electrical plug is firmly seated and locked in place.

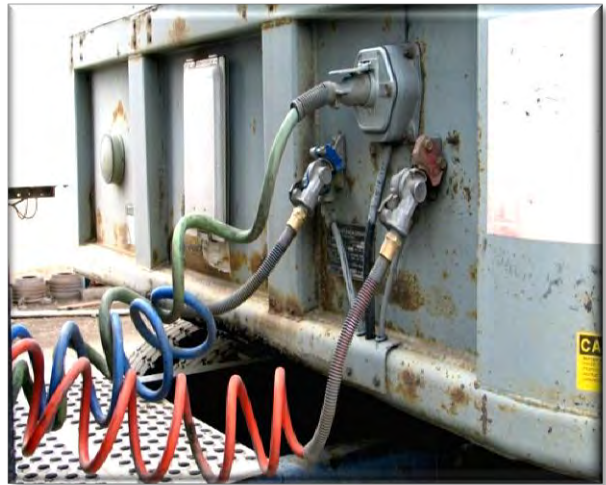

11.17.2 Header Board (Headache Rack) or Bulkhead:

Description: Prevents cargo from shifting forward and injuring driver when the vehicle abruptly stops.

Rationale: If not secure, may let cargo shift forward causing injury to the driver or damage to the equipment.



Inspection Points:

- ✓ If equipped, check the header board or bulkhead to see that it is secure, free of damage, and strong enough to contain cargo.
- ✓ If equipped, check to see that the canvas or tarp carrier is mounted and fastened securely.
- ✓ On enclosed trailers, check the front area for signs of damage (i.e., cracks, bulges, holes or missing rivets).



11.17.3 Tongue Storage Area:

Description: Platform located in the tongue of the trailer used for storage.

Rationale: If not secure, could move or shift causing injury to the driver or fall off and hit other traffic.



Inspection Points (Secure):

- ✓ Check to see that the storage area is solid and secured to the tongue; cargo in the storage area (i.e., chains, binders etc.) are secure.

11.18 TRAILER SIDE

11.18.1 Landing Gear:

Description: Supports front end of trailer when trailer is not coupled to a truck or tractor.

Rationale: Landing gear must be raised properly so that it will not strike the ground during travel. Landing gear must be in suitable condition to support the weight of the trailer and cargo. Its handle must be secured to the vehicle so it will not move and strike other traffic. Any damage to landing gear supports may result in the trailer tipping or falling over when disconnected.

Inspection Points (Fully Raised, Condition, Crank Handle):

- ✓ Check that landing gear is fully raised, has no missing parts, crank handle is secure, and the support frame and landing pads are not damaged.
- ✓ If power operated, check for air or hydraulic leaks.



11.18.2 Doors/Ties/Lifts:

Description: Side door, ties, chains, cables, ropes, cinches, or other devices used to secure cargo. Lift for loading and unloading cargo.

Rationale: Doors must be closed and latched to prevent cargo loss.

Inspection Points (Condition, Operation):

- ✓ Check that doors and hinges are not damaged and that they open, close and latch properly.
- ✓ Check that ties, straps, chains, and binders are secure.
- ✓ If equipped with a cargo lift, look for leaking, damaged, or missing parts and explain how it should be checked for correct operation.
- ✓ Check to see that the lift is fully retracted and latched securely.

11.18.3 Trailer Frame:

Description: Structural members for supporting vehicle body or trailer platform over wheels. Loose cross members may reduce vehicle stability and cause handling and cornering problems (i.e., wandering, possible rollover). Cracks may break, resulting in total loss of vehicle control. Cracks in members are most likely to appear midway between points of attachment to vehicle assemblies.

Inspection Points (Condition, Broken Welds, Holes):

- ✓ Check for cracks or bends in longitudinal frame members.
- ✓ Check for loose, cracked, bent, broken, or missing cross members.
- ✓ Look for signs of breaks or holes in box or trailer floor.

11.18.4 Tandem Release Arm/Locking Pins:

Description: Sliding mechanism and locking pins for sliding tandem axles on trailers.

Inspection Points (Secure):

- ✓ If equipped, make sure the locking pins are in place and release arm is secured.

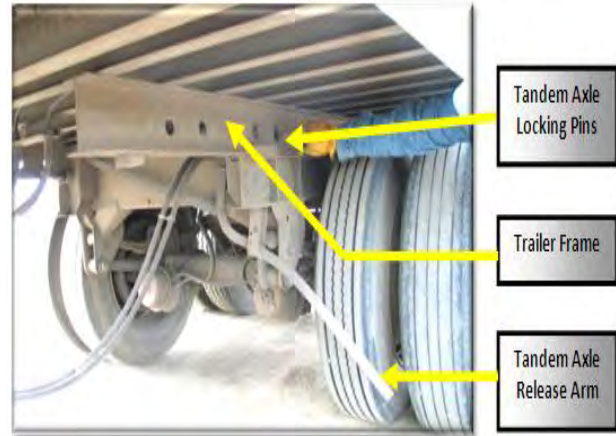

11.18.5 ABS Warning Light:

Description: Procedures to be followed in checking the anti-lock braking system (if equipped)

Rationale: Malfunctioning ABS can impact a driver's performance when reacting to an emergency.



Inspection Points (Operational):

- ✓ Check the ABS Light on the rear driver's side of the trailer. If the ABS light remains illuminated, the ABS is **NOT** functioning properly and needs to be serviced.

11.19 TRAILER REAR

11.19.1 Rear Door/Ties/Lifts:

Description: Rear door, ties, chains, cables, ropes, cinches, or other devices used to secure cargo. Lift for loading and unloading cargo.

Rationale: Doors must be closed and latched to prevent cargo loss.



Special Note: Idaho Code §49-949(1)(a)(b) and (2)(a)(b) – Requirement as to fender or covers over all wheels on motor vehicles – lists the rear fender and/or mud flap/splash guard requirements for operating or moving any vehicle, truck, bus, semitrailer or trailer on any highway.

Inspection Points (Condition, Operation):

- ✓ Check that doors and hinges are not damaged and that they open, close and latch properly.
- ✓ Check that ties, straps, chains, and binders are secure.
- ✓ If equipped with a cargo lift, look for leaking, damaged, or missing parts and explain how it should be checked for correct operation.
- ✓ Check to see the lift is fully retracted and latched securely.

Inspection Points (Secure, Covers Both Wheels, 10" From Ground):

- ✓ If equipped, check that mud flaps (splash guards) are not damaged and are mounted securely.
- ✓ Check to see that mud flaps cover the width of the tire(s).
- ✓ Check to see that mud flaps reach within 10 inches of the road surface (vehicle empty).

11.19.2 Mud Flaps (Splash Guards):

Description: Heavy rubber mats located behind back tires that prevent flying debris from hitting other vehicles. Mud flaps are not required if the body of the vehicle extends more than 5 feet beyond the rear wheels, or if the rear wheels are covered or enclosed by fenders to within 10 inches of the road surface when the vehicle is empty. Note: Even if mud flaps are not required, if they are present on the vehicle, they must be inspected.



End of Truck Pre-Trip Section

School and Passenger bus applicants continue next page

11.20 ADDITIONAL PRE-TRIP INSPECTION ITEMS FOR SCHOOL BUSESSES

Special Note: The “All Vehicles” section of the pre-trip inspection form for the buses is the same as the inspection criteria for straight trucks and combination vehicles with the exception of the type of tires allowed on the front of vehicles transporting passengers. FMCSR §398.5(e) prohibits re-grooved, re-capped, or re-treaded tires on the front wheels of vehicles carrying passengers. This exception being noted, only the items specific to the buses will be covered in this section.

11.20.1 School Bus Internal Inspection

11.20.2 Student Mirror:

Description: Inside horizontal mirror over driver’s seat

Rationale: Allows the driver to monitor the activities and movements of the students inside the bus.

Inspection Points:

- ✓ Check for proper adjustment
- ✓ Check to see that mirror is clean, not damaged and securely mounted.

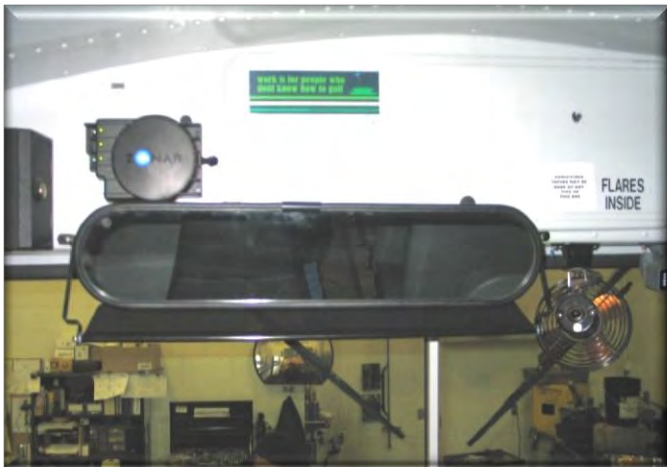

11.20.3 Eight-Way Lighting Indicators:

Description: Lighting indicators illuminate when corresponding lights are turned on (i.e., alternating flashing red or amber lights, strobe lights, etc).

Inspection Points:

- ✓ Check that internal panel lights illuminate when corresponding systems are activated.



11.20.4 Stop Arm Mechanism:

Description: Stop arm (sign) on the side of the bus that swings out when students load and/or unload when the red alternating flashing lights are activated.

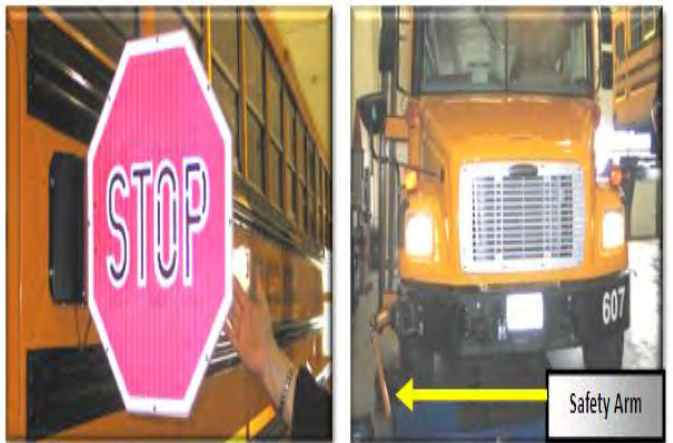

Inspection Points (Secure, Operational):

- ✓ Check the stop arm to see that it is mounted securely to the vehicle frame.
- ✓ Check for loose fittings and damage

- ✓ Check that stop arm extends fully when operated.
- ✓ Check that stop arm lights are operational
- ✓ If equipped, check that safety arm is securely mounted and functions properly in conjunction with stop arm.

11.20.5 Passenger Entry Door:

Description: Bus door(s) used for normal entry or exit. Handicap lift used for wheel chair accessibility.

Rationale: All passengers must be able to enter and exit safely.

Inspection Points (Condition, Operation):

- ✓ Check that the entry door is not damaged, operates smoothly, and closes securely.



11.20.6 Passenger Entry Stairs:

Description: Stair leading into the bus

Inspection Points (Condition):

- ✓ Check that entry steps are clear with the treads not loose or worn excessively.



11.20.7 Passenger Entry Handrail:

Description: Passenger handrail to aid students entering and leaving the bus.

Inspection Points (Secure):

- ✓ Check that hand rail(s) are secure and the step light is working.

11.20.8 Emergency Equipment:

Description: Used during a breakdown or at an accident. School bus emergency equipment includes a first aid kit, body fluid clean-up kit, and seat belt cutter on buses equipped with belts and/or wheel chair tie-downs.

Inspection Points (First Aid Kit, Body Fluid Kit, Seat Belt Cutter):

- ✓ Check for a first aid kit meeting Idaho standards for content.



- ✓ Check for a body fluid clean-up kit
- ✓ Check for a seat belt cutter on any bus equipped with belts or wheel chair tie-downs.



11.20.9 Passenger Seats:

Description: Seating for passengers on buses must be safe for passengers to sit in.

Inspection Points (Seat Backs, Seat Cushions, Seat Secured to Floor):

- ✓ Check to see seat backs and frames are not broken.



- ✓ Check to see seat cushions are securely attached to the seat frames and not excessively damaged (i.e., cuts, tears, etc).



- ✓ Check to see that seats are firmly attached to the floor.



11.21 EMERGENCY EXITS

Special Note: The State of Idaho, Department of Education, has set the standards for warning devices on emergency exits for school buses as follows: Emergency exit doors shall include an alarm system that includes an audible warning device at the emergency door exit and also in the driver's compartment. Emergency exit side windows shall include an alarm system that includes an audible warning device in the driver's compartment. Roof hatches do not require an alarm system, but if so equipped, they must be operable and include an audible warning device in the driver's compartment.

11.21.1 Windows

Description: Push out windows used for emergency evacuation of the bus compartment.

Inspection Points (Condition, Operation, Alarm):

- ✓ Demonstrate that a least one emergency exit window operates smoothly, closes securely, and is not damaged.
- ✓ Check that an alarm sounds inside the bus when the window is opened and shuts off when it is closed.



11.21.2 Rear/Side Door(s):

Description: Rear and/or side emergency exit doors.

Inspection Points (Condition, Operation, Alarm):

- ✓ Demonstrate that at least one emergency exit door(s) operates smoothly, closes securely, and is not damaged.
- ✓ Check that door release handle can be operated properly from both inside and outside the bus.
- ✓ Check to see that alarm buzzer sounds when the door is opened and shuts off when it is closed.



11.21.3 Emergency Roof Hatches:

Description: Emergency roof escape hatches.

Inspection Points (Condition, Operation, Alarm):

- ✓ **VERBALLY DESCRIBE** how the emergency roof exit hatch(s) operate. Only one hatch has to be discussed.
- ✓ Describe that the emergency exit-warning device will sound when the hatch is opened and closed.



11.22 EXTERNAL INSPECTION

11.22.1 Mirrors:

Description: Side mirrors for rear view of traffic to the sides and behind and passenger entry/exit mirrors for observing students.

Rationale: The driver must be able to see traffic and observe student movement during the loading and unloading process.



Inspection Points (Condition, Secure):

- ✓ Check that all external mirrors and mirror brackets are not damaged and are mounted securely with no loose fittings.
- ✓ Check that visibility is not impaired due to dirty mirrors.

11.22.2 Fuel Tank:

Description: Holds fuel.



Inspection Points (Secure, Condition, Leaks):

- ✓ Check that fuel tank(s) are secure.
- ✓ Check that fuel cap(s) are secure.



- ✓ Check for leaks from fuel tank(s) and fuel cap(s).
- ✓ Check to see that fuel access door (if equipped) is securely latched.



11.22.3 Battery/Box:

Description: A battery supplies electric energy to a vehicle for starting, lighting and ignition.



Inspection Points (Secure, Connection & Cell Caps, Condition):

- ✓ Check to see that battery(s) is secure.
- ✓ Check to see that battery box door is secure
- ✓ Check to see that connections are tight and all cell caps (if any) are present.
- ✓ Check to see that battery connections are not excessively corroded.



11.22.4 Compartments:

Description: Bus baggage and access panel compartments.



Inspection Points (Condition, Operation):

- ✓ Check baggage and all other exterior compartment doors for damage.

- ✓ Check to see that any baggage or other items are secure within the compartment.
- ✓ Check to see that all compartment doors are securely latched.

11.23 UNDER BUS

11.23.1 Exhaust System:

Description: Piping for removing combustion gases from engine.

Rationale: Leaks under the cab area can cause asphyxiation of driver or passengers.



Inspection Points (Condition, Leaks, Secure):

- ✓ Check that exhaust system is connected tightly, mounted securely, and there are no loose clamps.
- ✓ Check exhaust system for damage and signs of leaking (rust or carbon soot). Exhaust system should have no cracks, holes, or severe dents.

- ✓ Check to see that exhaust tail pipe extends outward from under the bus.



11.23.2 Drive Shaft:

Description: Transmits power from transmission to drive axle.

Rationale: Bent shaft, loose, or worn U-joints may cause excessive vibration. Loss of drive shaft could dig into pavement causing loss of vehicle control, serious vehicle damage and/or penetrate the passenger compartment. Also, shaft may come off, hitting other traffic.



Inspection Points (Condition, Secure, Guards):

- ✓ See that drive shaft is not bent, twisted, or cracked.
- ✓ Check that U-joints appear to be secure and free of foreign objects.
- ✓ If equipped, check drive shaft guards to see that they are secure and not damaged.

11.23.3 Frame:

Description: Structural members supporting vehicle body.

Rationale: Loose cross members may reduce vehicle stability and cause handling and cornering problems (i.e., wandering, possible rollover). Cracks may break, resulting in total loss of vehicle control.

Inspection Points (Condition, Broken Welds, Holes):

- ✓ Check for cracks or bends in longitudinal frame members.
- ✓ Check for loose, cracked, bent, broken or missing cross members.



11.24 FRONT & REAR LIGHTS

11.24.1 Alternating Flashing Amber and Red Lights:



Description: Alternately flashing amber lights (front and rear), alternately flashing red lights (front and rear), stop arm lights and strobe light (optional at this time). These lights warn applicants that the bus is

stopping to load or unload students. 7" diameter lights are located in upper corners on front and back of bus. Inside lights are amber. Outside lights are red.

Inspection Points:

- ✓ Check to see that all lights illuminate and are clean.



End of School Bus Pre-Trip Section

Coach/Transit bus applicants continue below

COACH/TRANSIT BUS

11.25 ADDITIONAL PRE-TRIP INSPECTION ITEMS FOR COACH/TRANSIT BUSES

11.25.1 Internal Inspection-Coach Bus

11.25.2 Passenger Entry Door:

Description: Bus door(s) used for normal entry or exit. Also includes lift mechanism for wheel chairs. All passengers must be able to enter and exit safely.

Inspection Points (Condition, Operational):

- ✓ Check to see that passenger entry door is not damaged, operates smoothly, and closes securely from the inside.

11.25.3 Passenger Entry Stair:

Description: Steps used by passengers to enter and exit the bus.

Inspection Points (Condition):

- ✓ Check to see that step light works.
- ✓ Make sure the entry steps are clear with the treads not loose or worn excessively.

11.25.4 Passenger Entry Handrail:

Description: Rail located in passenger entry to aid people boarding and exiting the bus.

Inspection Points (Secure):

- ✓ Check to see that handrails are securely mounted.



11.25.5 Passenger Lift:

Description: Handicap lift used for wheel chair accessibility.

Inspection Points (Condition, Operational, Secure):

- ✓ Look for leaking, damaged, or missing parts.
- ✓ Explain how lift should be checked for correct operation.
- ✓ Check to see that lift is fully retracted and latched securely.



11.25.6 Seats:

Description: Seating for passengers on buses. Seats must be safe for passengers to sit in.

Inspection Points (Seat Backs, Seat Cushions, Seat Secured to Floor):

- ✓ Check to see that there are no broken seat backs and frames
- ✓ Check to see that seat frames are firmly attached to the floor.
- ✓ Check to see that the seat cushions are attached securely to the seat frames.



11.26 EMERGENCY EXITS

11.26.1 Windows:

Description: Push-out windows for emergency passenger evacuation.

Inspection Points (Condition, Operation, Alarm):

- ✓ Demonstrate that at least one emergency window exit operates smoothly, closes securely, and is not damaged. You must confirm that the exit works properly
- ✓ Check that window release handle can be operated properly.
- ✓ If equipped, check to see that emergency exit-warning device activates when window is opened and deactivates when it is closed.

11.26.2 Doors:

Description: Emergency Exit door(s) used for passenger evacuation.

Inspection Points (Condition, Operation, Alarm):

- ✓ Demonstrate that at least one emergency exit door operates smoothly, closes securely, and is not damaged. You must confirm that the exit works properly.
- ✓ Check door(s) release handle to ensure it can be operated both from inside and outside the bus.
- ✓ If equipped, check that emergency exit-warning device activates when door is opened and deactivates when it is closed.

11.26.3 Hatches:

Description: Roof hatches used to evacuate passengers in an emergency.

Inspection Points (Condition, Operation, Alarm):

- ✓ Describe how at least one emergency exit hatch operates; how it must close securely, and is not damaged.
- ✓ Check hatch(s) release handle to ensure it is operational.

- ✓ If equipped, describe how the emergency exit-warning device activates when the hatch is opened and deactivates when it is closed.

Special Note: Do not open the emergency hatch, because it can be very difficult to close and secure. Verbally describe the operation and check for the roof hatch.

11.27 EXTERNAL INSPECTION

11.27.1 Level/Air Leaks:

Description: Coach and transit buses generally have air suspension systems.

Inspection Points:

- ✓ Check to see vehicle is sitting level from front to rear and side to side.
- ✓ If air-equipped, check for audible air leaks from the suspension system.

11.27.2 Mirrors:

Description: Side mirrors for rear view of traffic to the sides and behind and passenger entry/exit mirrors.

Inspection Points (Condition, Secure):

- ✓ Check that all external mirrors and mirror brackets are not damaged and are mounted securely with no loose fittings.
- ✓ Check that visibility is not impaired due to dirty mirrors.

11.27.3 Fuel Tank:

Description: Tank (s) that holds fuel. Leaks are a fire hazard and can cause driving hazards to other traffic. Fuel on pavement can be very slippery.

Inspection Points (Secure, Condition, Leaks):

- ✓ Check to see that the tank is secure.
- ✓ Check to see that the cap(s) is secure.

- ✓ Check to see that the tank and lines are not damaged or leaking.

- ✓ Check to see that the doors operate properly and latch securely.

11.27.4 Battery/Box:

Description: The vehicle battery may be located on the side of the vehicle or in the engine compartment.

Inspection Points (Secure, Connection & Cell Caps, Condition):

- ✓ Check to see that the battery(s) is secure. Also check the battery box and cover or door to see that they are secure.
- ✓ Check to see that the cable connections are tight and cell caps are present.
- ✓ Check to see that the battery connections are not excessively corroded.

- ✓ Check to see that baggage and/or equipment (if any) is secure within the compartment.

11.27.6 Mud flaps (Splash Guards):

Description: Heavy rubber mats located behind back tires that prevent flying debris from hitting other vehicles. Mud flaps are not required if the body of the vehicle extends more than 5 feet beyond the rear wheels, or if the rear wheels are covered or enclosed by fenders to within 10 inches of the road surface when the vehicle is empty.

Special Note: Although mud flaps may not be required on a vehicle, if they are present, they must be inspected.

11.27.5 Baggage Compartment/Doors/Baggage:

Description: Bus baggage compartment doors.

Inspection Points (Secure, Condition, Operation):

- ✓ Check to see that baggage and all other exterior compartment doors are not damaged.

Inspection Points (Secure, Covers Both Wheels, 10" From Road Surface):

- ✓ Check to see that mud flaps are secure and in good condition.
- ✓ Make sure mud flaps extend to each side of the tires.
- ✓ Make sure mud flaps reach within 10 inches of the road surface.



Chapter 12 : Basic Control Skills

This Chapter Covers:

- 🚧 Skills Test Scoring
- 🚧 Skills Test Exercises

Introduction: The basic control skills tests are designed to test your judgment. They also test your ability to perform basic skill maneuvers that are essential for the safe operation of commercial vehicles. Although you may not perform all of these particular maneuvers on the job, the ability to control a vehicle and judge the vehicle's position in relation to other objects is very important. The following exercises are designed to test your performance of these basic control skills.

Test Exercises: Your basic control skills test will consist of three (3) of the following six (6) exercises. The tests will be conducted primarily off-road on courses set up by the examiner, but the examiner may also ask you to perform one or more of the exercises somewhere on the street during the road test:

- 🚧 Straight line backing
- 🚧 Offset back/right
- 🚧 Offset back/left
- 🚧 Parallel Park (driver side)
- 🚧 Parallel Park (conventional)
- 🚧 Alley dock



These exercises as well as the required course dimensions are shown at the end of this chapter.

Category of Test Exercises: The examiner will choose the exercise he/she wishes you to perform. The examiner will include one exercise from each of the following three (3) categories:

Category 1 (Always Used):

1. **Straight Line Back**

Category 2 (Examiner will pick one):

1. **Offset Back – Left**
2. **Offset Back – Right**

Category 3 (Examiner will pick one):

1. **Sight Side Parallel Park**
2. **Conventional Parallel Park**
3. **Alley Dock**

For example, you may be asked to perform a Straight Line Backing, Offset Back – Left, and the Alley Dock exercises for your test. It is important that you practice and know how to perform all six (6) exercises because you will not know which ones the examiner will ask you to do for your test.

12.1 SCORING

- 🚧 **Crossing Boundaries (encroachments)**
- 🚧 **Pull-ups**
- 🚧 **Vehicle Exits**
- 🚧 **Final Position**

You must receive **12** errors or less to pass the basic control skills portion of the test.

Encroachments: The examiner will score the number of times you touch or cross over an exercise boundary line with any portion of your vehicle. Each encroachment will count as an error and each error is worth two (2) points.

Pull-ups: When a driver stops and reverses direction to get a better position, it is scored as a “pull-up”. Stopping without changing direction does not count as a pull-up. You will not be penalized for initial pull-ups; however, an excessive number of pull-ups, will count as errors and each error is worth one (1) point.

Outside Vehicle Observations (Looks): You may be permitted to safely stop and exit the vehicle to check the external position of the vehicle (look). When doing so, you must place the vehicle in neutral and set the parking brake(s). Then, when exiting the vehicle, you

must do so safely by facing the vehicle and maintaining three points of contact with the vehicle at all times. If you do not safely secure the vehicle or safely exit the vehicle it may result in an automatic failure of the skills test.

The maximum number of times that you may look to check the position of your vehicle is two (2) except for the Straight Line Backing exercise, which allows one look. Each time you open the door, move from a seated position where in physical control of the vehicle or, on a bus, walk to the back of a bus to get a better view, is scored as a “look”. You will not receive any points for free “looks”; however, you will not be allowed to exceed the total number permitted for the exercise.

Final Position: It is important that you finish each exercise exactly as the examiner has instructed you. If you do not maneuver the vehicle into its final position as described by the examiner, you will be penalized 10 points and could fail the skills test. You are allowed to measure the distance from the rear of your vehicle to the exercise boundary line. You are also permitted to place a reference mark or object to aid you in positioning the vehicle within the exercise boundary.

You will not be allowed to end any backing exercise with an encroachment. If you have set the brake and sounded the horn indicating final position and you are over or touching a boundary line, the examiner will instruct you to maneuver the vehicle back into the boundary lines of the exercise. The examiner will score you for an encroachment and a pull-up once you return within bounds.

12.2 EXERCISES & COURSE DIMENSIONS

12.2.1 Straight Line Backing

You may be asked to back your vehicle in a straight line between two rows of cones without touching or crossing over the exercise boundaries.

(See Figure 12.1)

12.2.2 Offset Back/Right

You may be asked to back into a space that is to the right rear of your vehicle. You will drive straight forward and back your vehicle into that space without striking the side boundaries marked by cones. You must place your vehicle completely into the space so that your front bumper is behind the first set of cones. (See Figures 12.2 and 12.7)

12.2.3 Offset Back/Left

You may be asked to back into a space that is to the left rear of your vehicle. You will drive straight forward and back your vehicle into that space without striking the side boundaries marked by cones. You must place your vehicle completely into the space so that your front bumper is behind the first set of cones. (See Figures 12.3 and 12.7)

12.2.4 Parallel Park (Driver Side)

You may be asked to park in a parallel parking space that is on your left. You are to drive past the parking space and back into it bringing the rear of your vehicle as close as possible to the rear of the space without crossing side or rear boundaries marked by cones. You are required to get your vehicle completely into the space. (See Figures 12.4 and 12.8)

12.2.5 Parallel Park (Conventional)

You may be asked to park in a parallel parking space that is on your right. You are to drive past the parking space and back into it bringing the rear of your vehicle as close as possible to the rear of the space without crossing side or rear boundaries marked by cones. You are required to get your vehicle completely into the space. (See Figures 12.5 and 12.8)

12.2.6 Alley Dock

You may be asked to sight-side back your vehicle into an alley, bringing the rear of your vehicle as close as possible to the rear of the alley without going beyond the exercise boundary marked by a line or row of cones. You are required to get your vehicle completely into the space with your entire vehicle straight within the alley. (See Figures 12.6 and 12-9)

Figure 12.1 Straight Line Backing

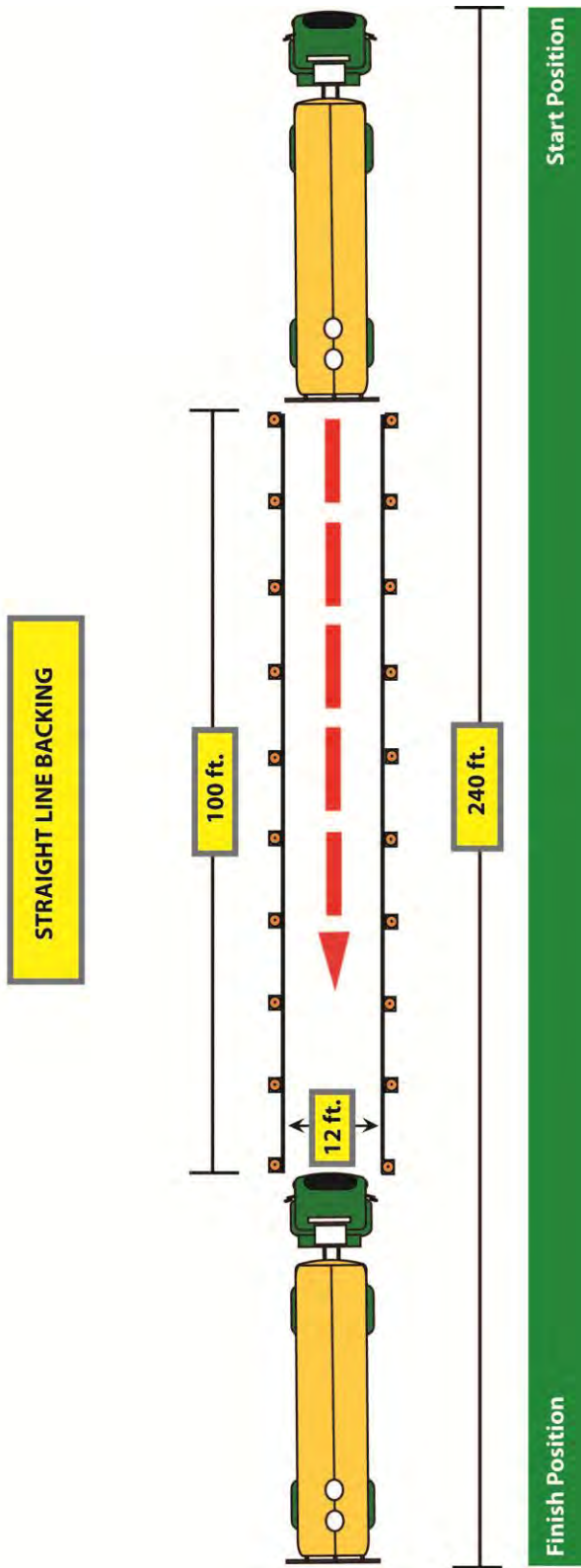

Figure 12.2 Offset Backing - Right

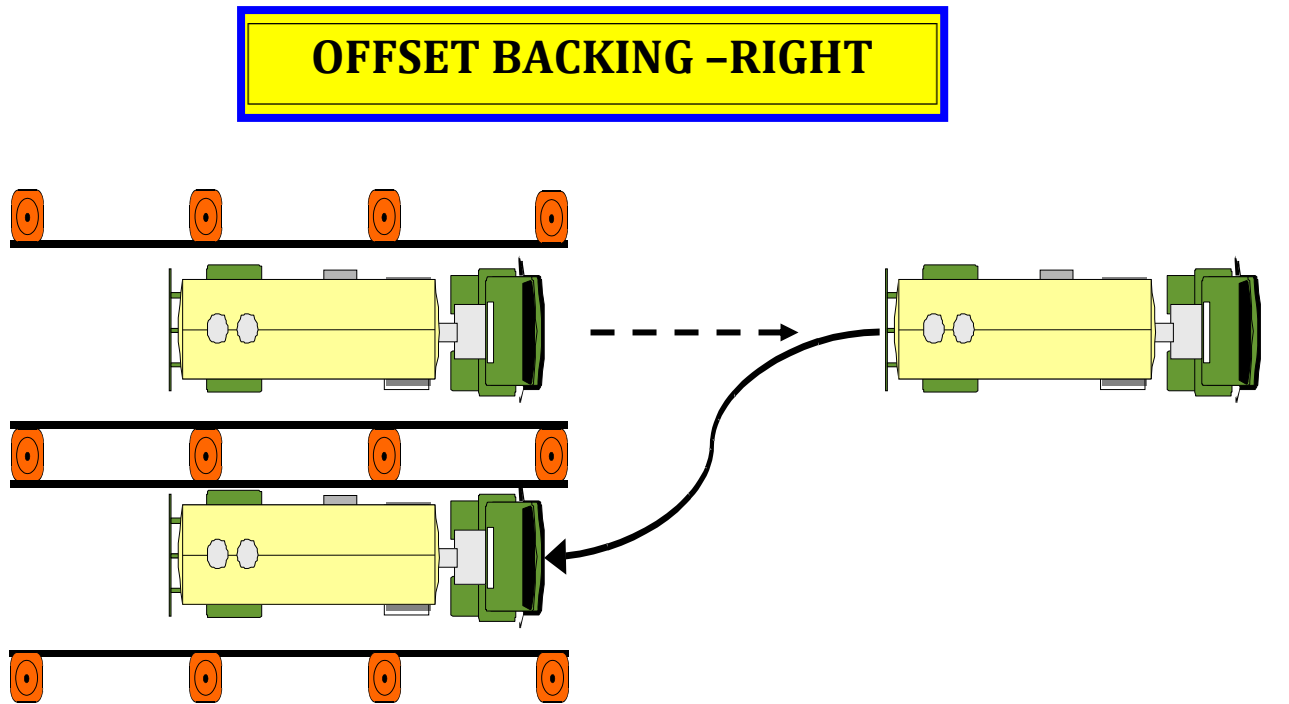

Figure 12.3 Offset Backing - Left

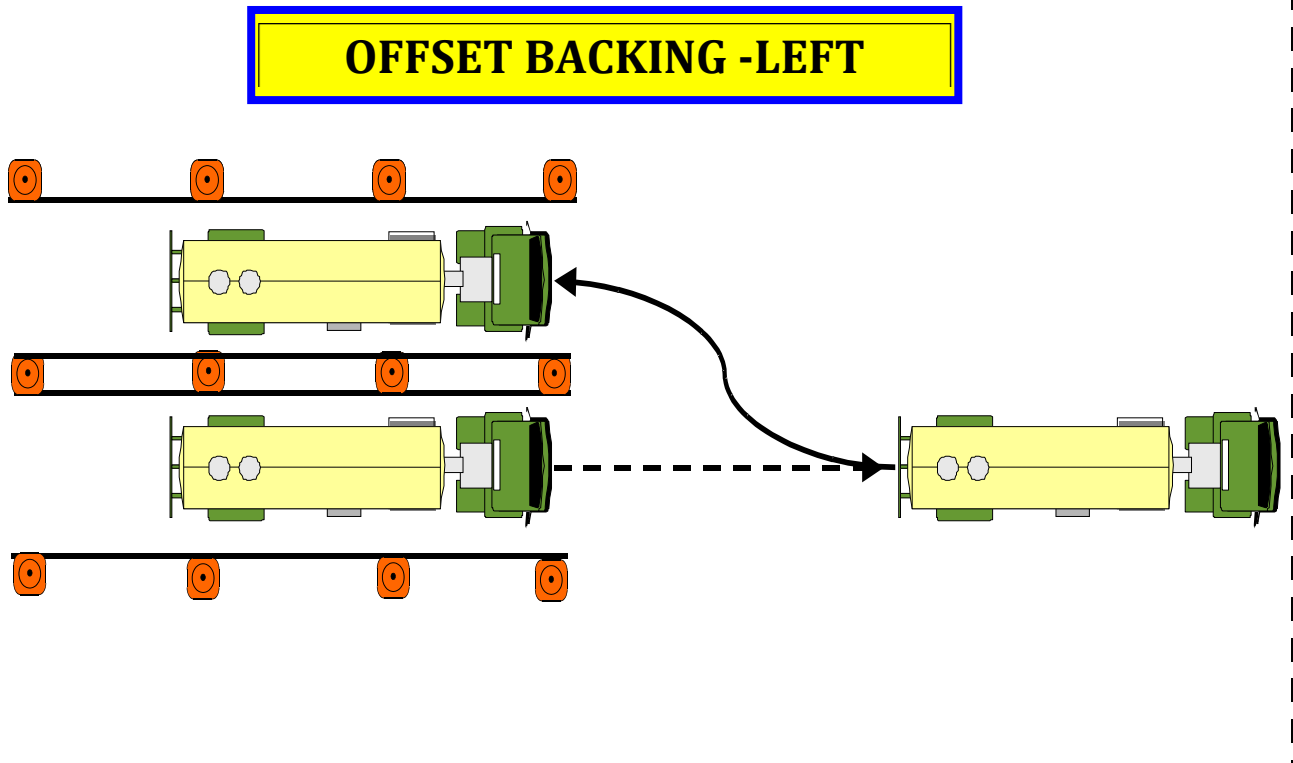

Figure 12.4 Parallel Park - Driver's Side

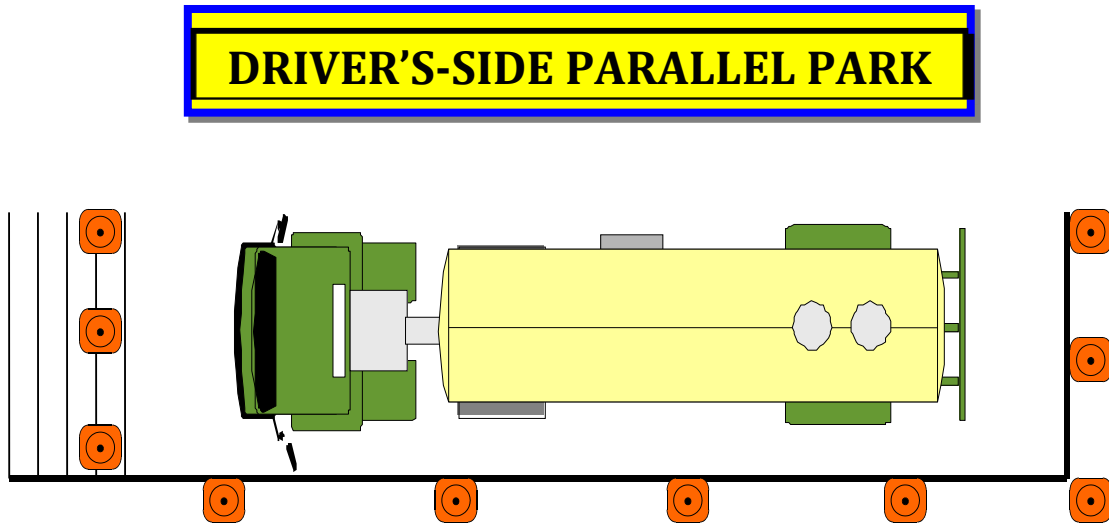

Figure 12.5 Parallel Park - Conventional

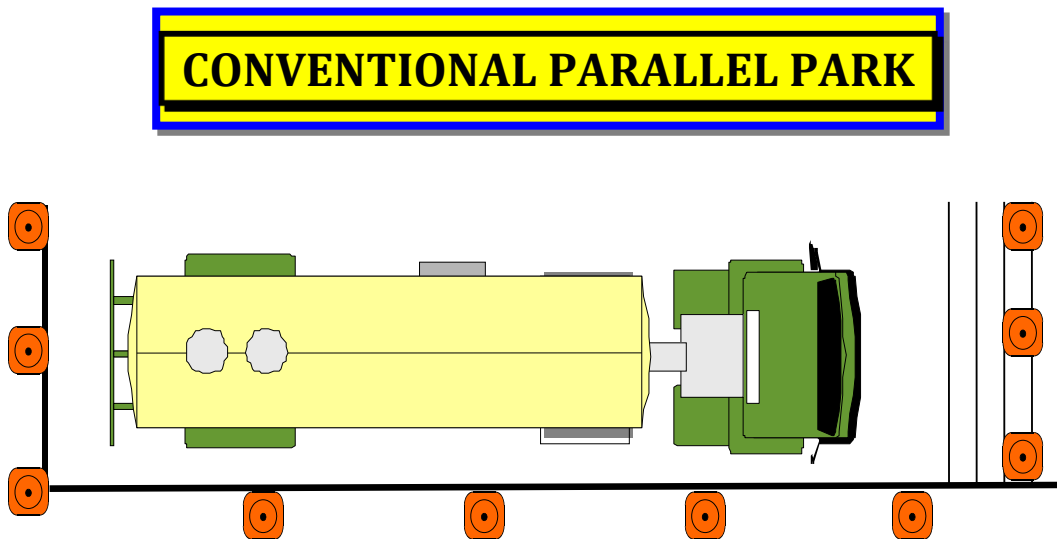

Figure 12.6 Alley Dock

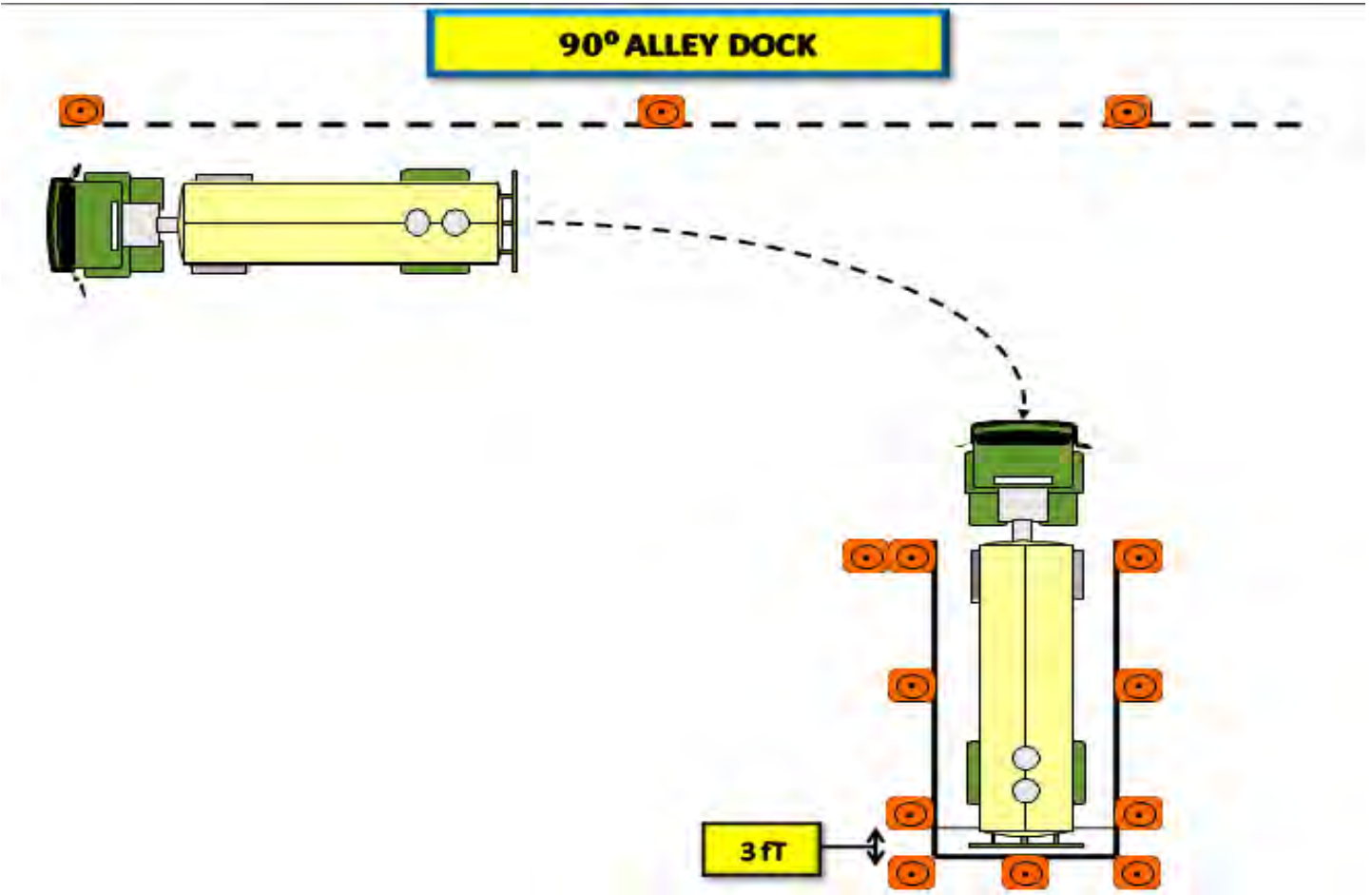

Figure 12.7 Offset Backing Course Dimensions

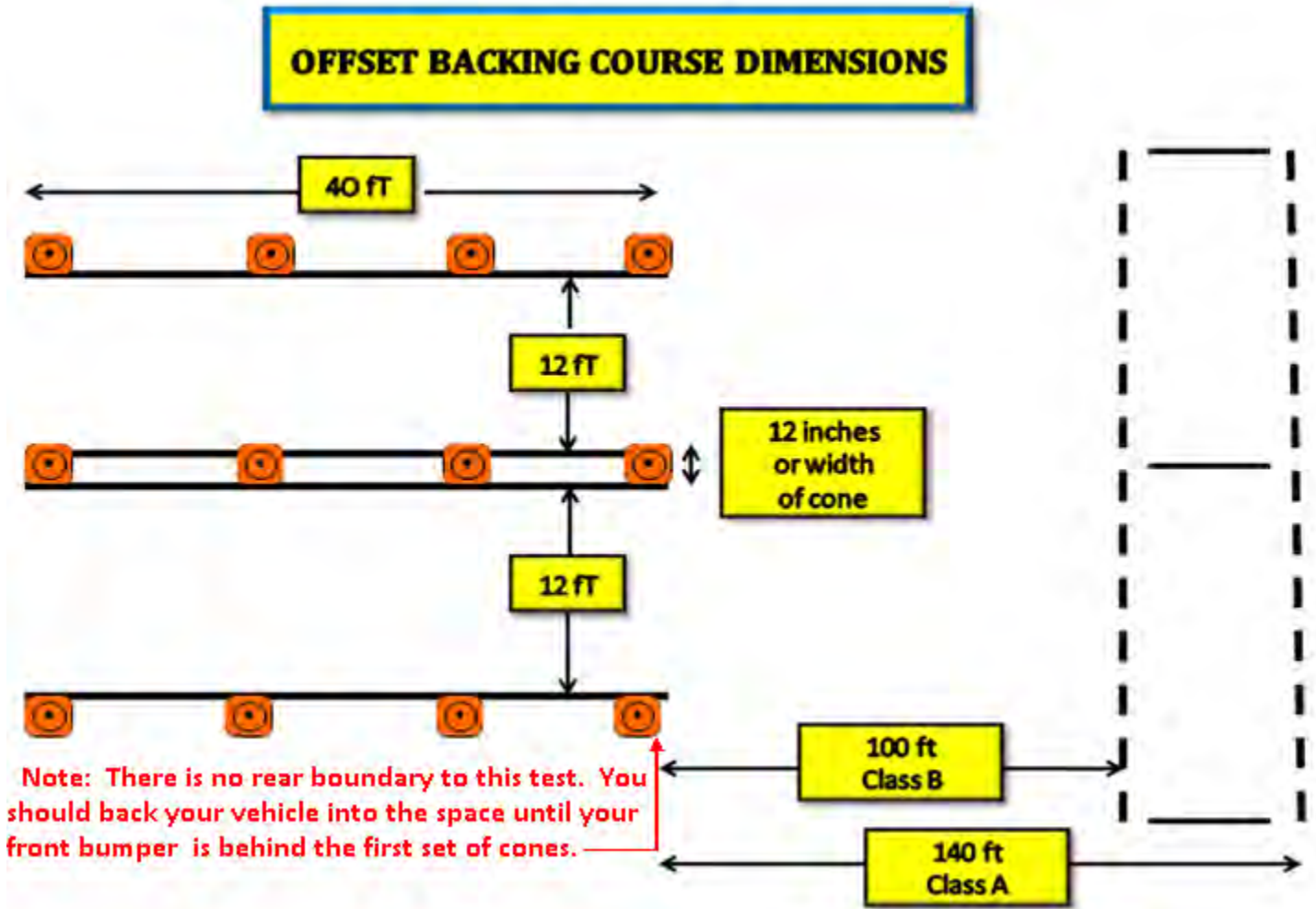

Figure 12.8 Parallel Park Course Dimensions

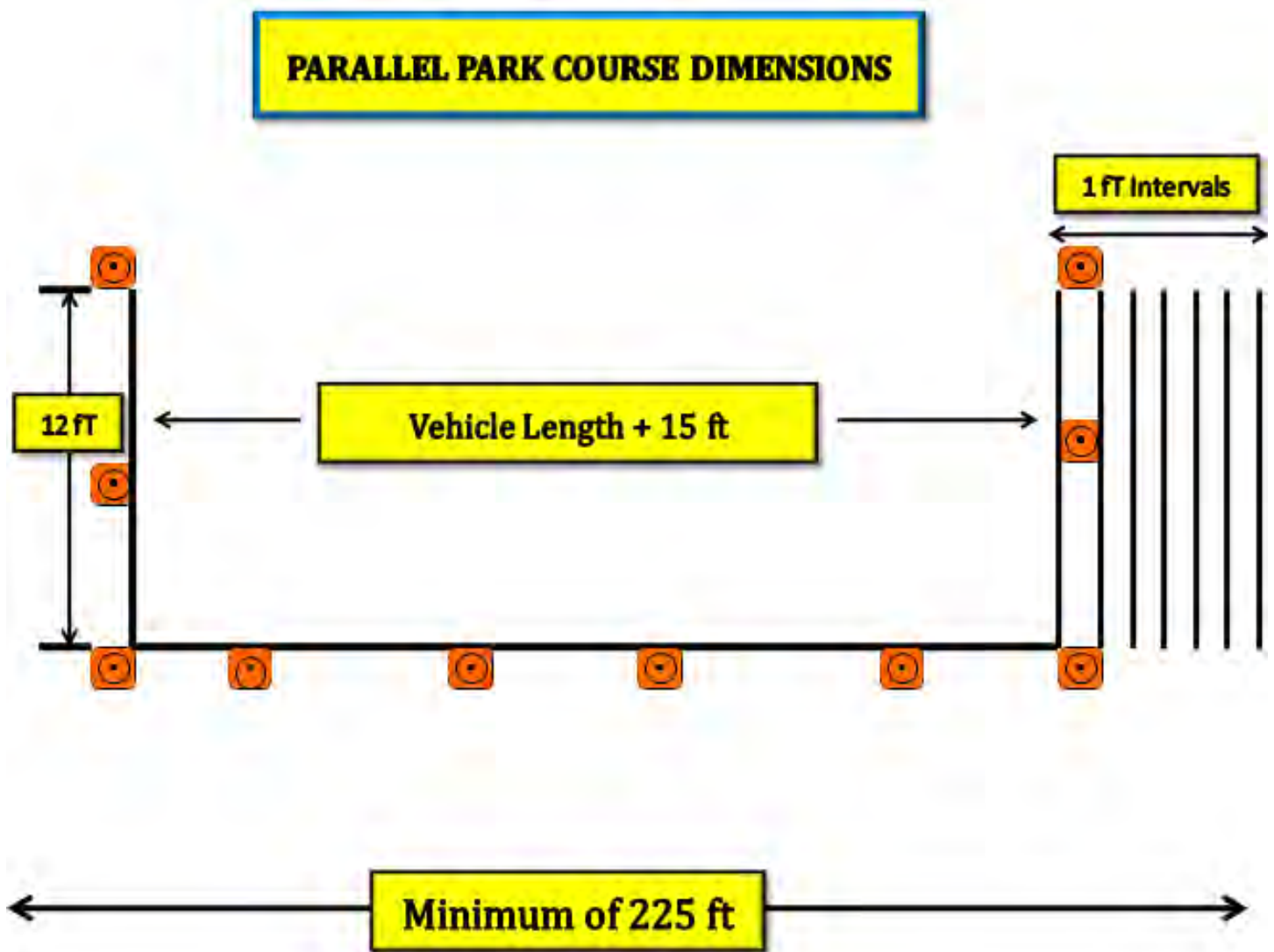
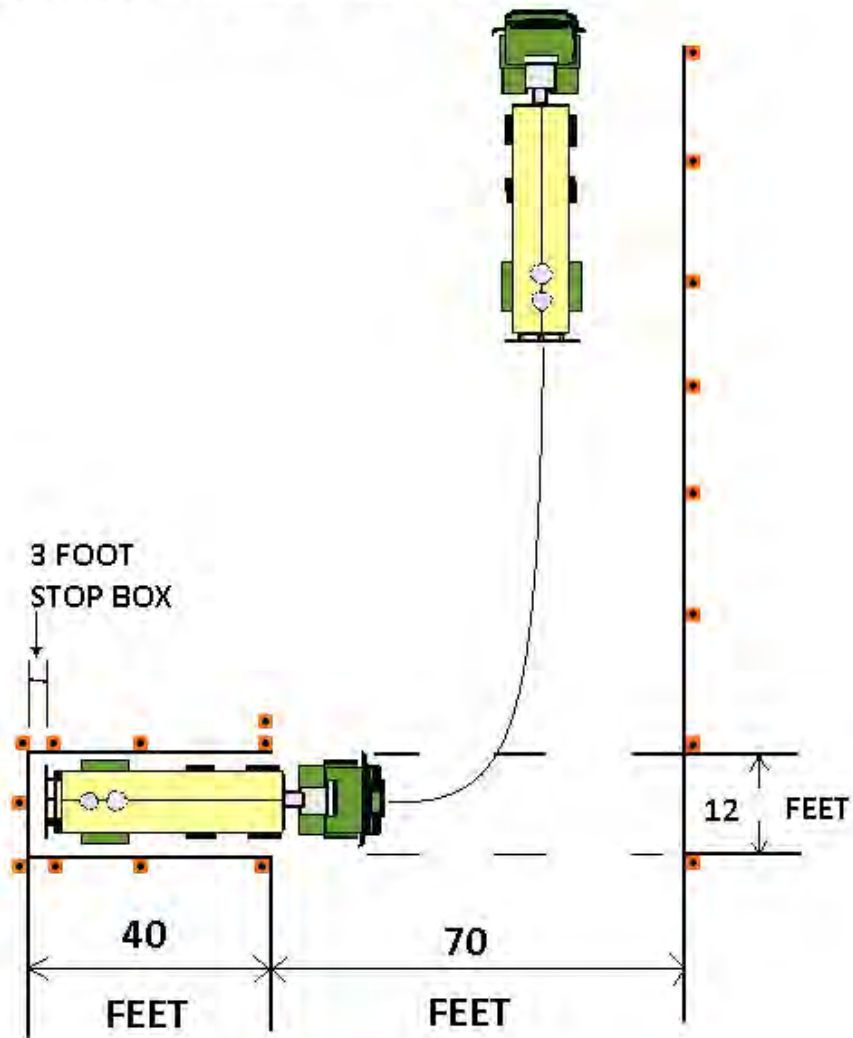

Figure 12.9 Alley Dock Course Dimensions

ALLEY DOCK MEASUREMENTS- CLASS A COMBINATION VEHICLES



NOTE:
THIS MEASUREMENT FOR
CLASS B AND C TRUCKS
AND BUSES IS 50 FEET.

Chapter 13 : Road Test

This Chapter Covers:



How You Will Be Tested

Introduction: The Road Test evaluates your ability to drive safely in most on-the-road situations. The objective is to identify those who lack the skill to safely operate a commercial vehicle under normal traffic conditions

You will drive over a test route that has a variety of traffic situations and will take approximately 30 to 45 minutes. At all times during the test, you must drive in a safe and responsible manner; and

- ! Wear your safety belt.
- ! Obey all traffic signs, signals, and laws.
- ! Complete the test without an accident or moving violation.

During the driving test, the examiner will be scoring you on specific driving maneuvers as well as on your general driving behavior. You will follow the directions of the examiner. Directions will be given to you so you will have plenty of time to do what the examiner has asked. You will not be asked to drive in an unsafe manner.

If your test route does not have certain traffic situations, you may be asked to simulate a traffic situation. You will do this by telling the examiner what you are or would be doing if you were in that traffic situation. You must receive a score of **30** errors or less to pass the road test portion of the skills test.

13.1 HOW YOU WILL BE TESTED

13.1.1 Turns:

You have been asked to make a turn:

- Check traffic in all directions.
- Use turn signals and safely get into the lane needed for the turn.
 - As you approach the turn-

- Use turn signals to warn others of your turn.
 - Slow down smoothly, change gears as needed to keep power, but do not coast unsafely. Unsafe coasting occurs when your vehicle is out of gear (clutch depressed or gearshift in neutral) for more than the length of your vehicle.
- If you must stop before making the turn:
- Come to a smooth stop without skidding.
 - Come to a complete stop behind the stop line, crosswalk, or the intersecting road's curb line.

Special Note: A stop sign is not the legal marker for an intersection.

Idaho Code, § 49-110 (10) (a) (b) (c), defines an intersection as follows:

“Intersection” means:

(a) The area embraced within the prolongation or connection of the lateral curb lines, or, if none, then the lateral boundary lines of the roadways of two (2) highways which join one another at, or approximately at, right angles, or the area within which vehicles traveling upon different highways joining at any other angle may come in conflict.

(b) Where a highway includes two (2) roadways thirty (30) feet or more apart, then every crossing of each roadway of the divided highway by an intersecting highway shall be regarded as a separate intersection. In the event an intersecting highway also includes two (2) roadways thirty (30) feet or more apart, then every crossing of two (2) roadways of the highways shall be regarded as a separate intersection.

(c) The junction of an alley with a street or highway shall not constitute an intersection.

Idaho Code § 49-807 (2) (a) (b) (c), discusses where a person is required to stop at an intersection and reads as follows:

(2) Except when directed to proceed by a peace officer or traffic-control signal, every driver of a vehicle approaching a stop sign shall stop:

- (a) at a clearly marked stop line, or*
- (b) before entering the crosswalk on the near side of the intersection, or*
- (c) at the point nearest the intersecting highway where the driver has a view of approaching traffic on the intersecting highway before entering it.*

After having stopped, the driver shall yield the right-of-way to any vehicle in the intersection or approaching on another highway so closely as to constitute an immediate hazard during the time when such driver is moving across or within the intersection or junction of highways. (See Figure 13-1)

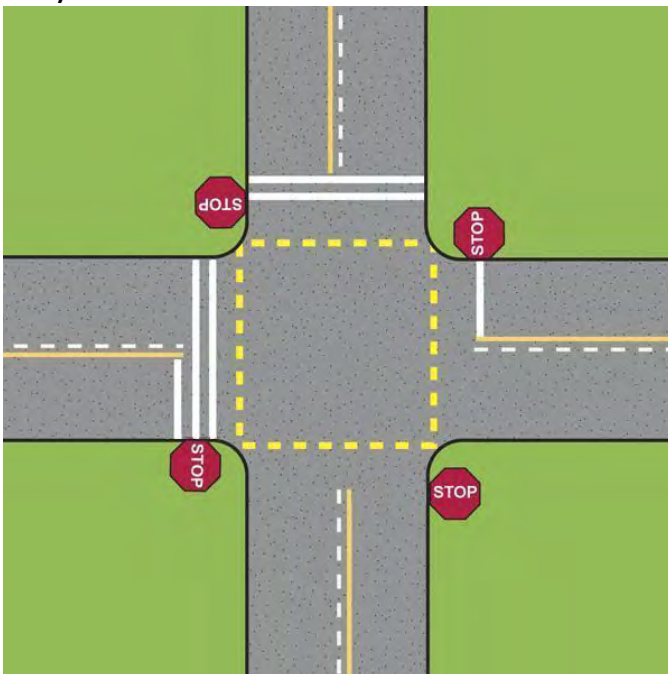

Figure 13.1

- If stopping behind another vehicle, stop where you can see the rear tires on the vehicle ahead of you (safe gap).

- Do not let your vehicle roll.
- Keep the front wheels aimed straight ahead.
- When ready to turn:
 - **Check traffic** in all directions.
 - Keep **both hands on the steering wheel** during the turn.
 - Keep **checking your mirror** to make sure the vehicle does not hit anything on the inside of the turn.
 - Vehicle should not move into oncoming traffic.
 - Vehicle should finish turn in correct lane.
- After turn:
 - Make sure turn signal is off.
 - Get up to speed of traffic, use turn signal, and move into right-most lane when safe to do so (if not already there).
 - Check mirrors and traffic.

13.1.2 Intersections

As you approach an intersection:

- **Check traffic** thoroughly in all directions.
- Decelerate gently.
- Brake smoothly and, if necessary, change gears.
- If necessary, come to a complete stop (no coasting) behind any intersecting roadway's curb line, signals, sidewalks, or stop lines maintaining a safe gap behind any vehicle in front of you.
- Your vehicle must not roll forward or backward.

When driving through an intersection:

- **Check traffic** thoroughly in all directions.
- Decelerate and yield to any pedestrians and traffic in the intersection.
- Do not change lanes while proceeding through the intersection.
- Keep your hands on the wheel.

Once through the intersection:

- Continue checking mirrors and traffic.
- Accelerate smoothly and change gears as necessary.

13.1.3 Urban/Rural Straight

During this part of the test, you are expected to make regular traffic checks and maintain a safe following distance. Your vehicle should be centered in the proper lane (right-most lane) and you should keep up with the flow of traffic but not exceed the posted speed limit.

13.1.4 Lane Changes

During multiple lane portions of the test, you will be asked to change lanes to the left, and then back to the right. You should make the necessary traffic checks first, then use proper signals and smoothly change lanes when it is safe to do so.

13.1.5 Freeway/Expressway

Before entering the expressway:

- Check traffic.
- Use proper signals.
- Merge smoothly into the proper lane of traffic.

Once on the expressway:

- Maintain proper lane positioning, vehicle spacing, and vehicle speed.

- Continue to check traffic thoroughly in all directions.

When exiting the expressway:

- Make necessary traffic checks.
- Use proper signals.
- Decelerate smoothly in the exit lane.
- Once on the exit ramp, you must continue to decelerate within the lane markings and maintain adequate spacing between your vehicle and other vehicles.

13.1.6 Stop/Start

For this maneuver, you will be asked to pull your vehicle over to the side of the road and stop as if you were going to get out and check something on your vehicle. You must check traffic thoroughly in all directions and move to the right-most lane or shoulder of road.

As you prepare for the stop:

- Check traffic.
- Activate your right turn signal.
- Decelerate smoothly, brake evenly, change gears as necessary.
- Bring your vehicle to a full stop without coasting.

Once stopped:

- Vehicle must be parallel to the curb or shoulder of the road and safely out of the traffic flow.
- Vehicle should not be blocking driveways, fire hydrants, intersections, signs, etc.
- Cancel your turn signal.
- Activate your four-way emergency flashers.
- Apply the parking brake.
- Move the gear shift to neutral or park.

- Remove your feet from the brake and clutch pedals.

When instructed to resume:

- Check traffic and your mirrors thoroughly in all directions.
- Turn off your four-way flashers.
- Activate the left turn signal.
- When traffic permits, you should release the parking brake and pull straight ahead.
- Do not turn the wheel before your vehicle moves.
- Check traffic from all directions, especially to the left.
- Steer and accelerate smoothly into the proper lane when safe to do so.
- Once your vehicle is back into the flow of traffic, cancel your left turn signal.

13.1.7 Curve

When approaching a curve:

- Check traffic thoroughly in all directions.
- Before entering the curve, reduce speed so further braking or shifting is not required in the curve.
- Keep vehicle in the lane.
- Continue checking traffic in all directions.

13.1.8 Railroad Crossing

Before reaching the crossing, all commercial drivers should:

- Decelerate, brake smoothly, and shift gears as necessary.

- Look and listen for the presence of trains.
- Check traffic in all directions.

Do not stop, change gears, pass another vehicle, or change lanes while any part of your vehicle is in the crossing.

If you are driving a bus, a school bus, or a vehicle displaying placards, you should be prepared to observe the following procedures at every railroad crossing (unless the crossing is exempt):

- As the vehicle approaches a railroad crossing, activate the four-way flashers.
- Stop the vehicle within 50 feet but not less than 15 feet from the nearest rail.
- Listen and look in both directions along the track for an approaching train and for signals indicating the approach of a train. If operating a bus, you may also be required to open the window and door prior to crossing tracks.
- Keep hands on the steering wheel as the vehicle crosses the tracks.
- Do not stop, change gears, or change lanes while any part of your vehicle is proceeding across the tracks.
- Four-way flashers should be deactivated after the vehicle crosses the tracks.
- Continue to check mirrors and traffic.

Not all driving road test routes will have a railroad crossing. You may be asked to explain and demonstrate the proper railroad crossing procedures to the examiner at a simulated location.

13.1.9 Bridge /Overpass/Sign

After driving under an overpass, you may be asked to tell the examiner what the posted clearance or height was. After going over a bridge, you may be asked to tell the examiner what the posted weight limit was. If your test route does not have a bridge or overpass, you may be asked about another traffic sign. When asked, be

prepared to identify and explain to the examiner any traffic sign which may appear on the route.

13.1.10 Student Discharge (School Bus)

If you are applying for a School Bus endorsement, you will be required to demonstrate loading and unloading students. Please refer to Chapter 10 of this manual for procedures on loading and unloading school students.

You will be scored on your overall performance in the following general driving behavior categories:

13.1.11 Clutch Usage (for Manual Transmission)

- Use the clutch when necessary to shift. If you are proficient in shifting gears without the use of the clutch (Floating the Gears), you may do so without penalty; however, if you use this technique and continually grind or miss gears in shifting situations, you will be marked down accordingly.
- Double-clutch if vehicle is equipped with non-synchronized transmission.
- Do not rev or lug the engine.
- Do not ride clutch to control speed, coast with the clutch depressed, or "pop" the clutch.

13.1.12 Gear Usage (for Manual Transmission)

- Do not grind or clash gears.
- Select gear that does not rev or lug engine.
- Do not shift in turns and intersections unless it is necessary to do so.

13.1.13 Brake Usage

- Do not ride or pump brake.
- Do not brake harshly. Brake smoothly using steady pressure.

13.1.14 Lane Usage

- Do not put vehicle over curbs, sidewalks, or lane markings.
- Stop behind stop lines, crosswalks, or the curb line of the intersecting roadway.
- Complete a turn in the proper lane on a multiple lane road (vehicle should finish a left turn in the lane directly to the right of the center line).
- Finish a right turn in the right-most (curb) lane.
- Move to or remain in right-most lane unless lane is blocked.

13.1.15 Steering

- Do not over or under steer the vehicle.
- Keep both hands on the steering wheel at all times unless shifting. Once you have completed the shift, return both hands to the steering wheel.

13.1.16 Regular Traffic Checks

- Check traffic regularly.
- Check mirrors regularly.
- Check mirrors and traffic before, while in and after an intersection.
- Scan and check traffic in high volume areas and areas where pedestrians are expected to be present.

13.1.17 Use of Turn Signals

- Use turn signals properly.
- Activate turn signals when required.
- Activate turn signals at appropriate times.
- Cancel turn signals upon completion of a turn or lane change.

Page left blank intentionally

CDL Vehicle Inspection Memory Aid

Combination Vehicles

- Front of Vehicle, Lights/Reflectors, Engine Compartment & Steering Components
- Steering Axle
 - Suspension
 - Brakes
 - Tires
- Driver Door Fuel Area
- Engine Start Procedures
- Under Vehicle
 - Drive Shaft
 - Exhaust
 - Frame
- Drive Axle(s)
 - Suspension
 - Brakes
 - Tires
- Coupling Devices
 - Truck
 - Trailer
- Rear of Truck/Tractor & Lights/Reflectors
- Trailer Components
 - Front, Side, Lights & Reflectors
 - Frame
 - Landing Gear
 - Tandem Release
- Trailer Axle(s)
 - Suspension
 - Brakes
 - Tires
- Rear of Trailer and Lights/Reflectors

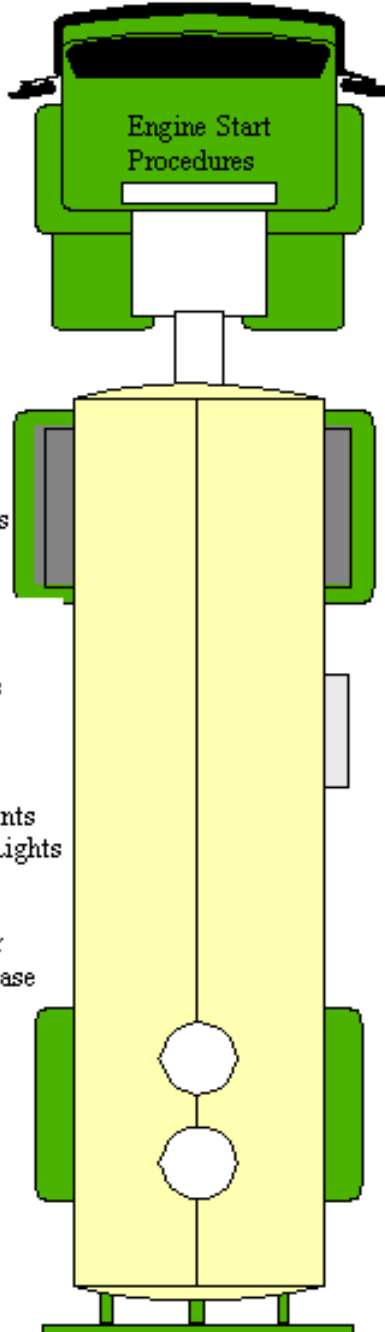

Straight Truck or Bus

- Front of Vehicle, Lights/Reflectors, Engine Compartment & Steering Components
- Steering Axle
 - Suspension
 - Brakes
 - Tires
- Driver Door Fuel Area
- Engine Start Procedures
- Under Vehicle
 - Drive Shaft
 - Exhaust
 - Frame
- Passenger Items (Buses Only)
- School Bus Items (Schools Bus Only)
- Side of Vehicle & Lights/Reflectors
- Drive Axle(s)
 - Suspension
 - Brakes
 - Tires
- Rear of Vehicle & Lights/Reflectors

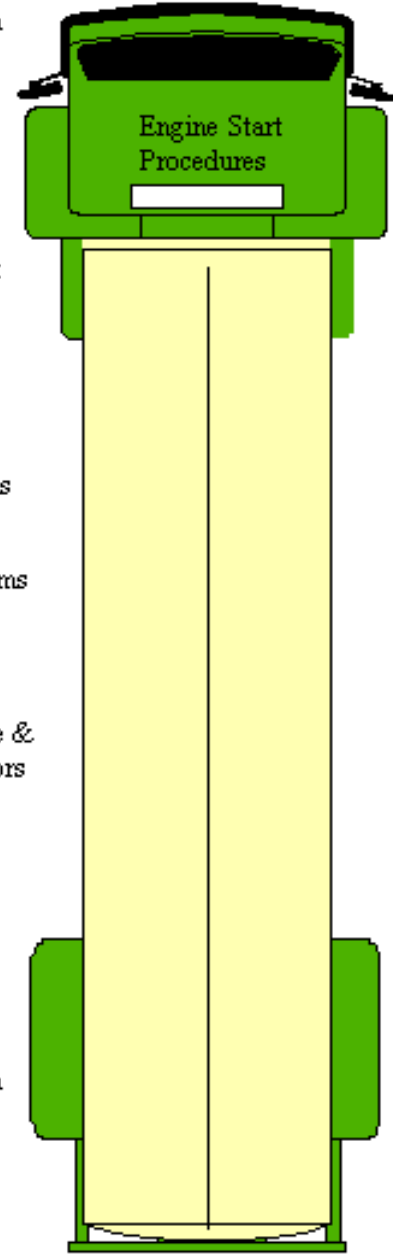

13.3 BRAKE TEST PRACTICE CHECKLIST

Step One: Parking Brake Test

Straight Truck and Buses:

With parking brake engaged: Check parking brake holds vehicle by gently trying to pull forward with parking brake on.

Combination Vehicles:

1. With parking brake ON & trailer brake (TPV) OFF: check parking brake holds vehicle by gently trying to pull forward.

With trailer brake (TPV) ON & parking brake OFF: check trailer brake holds vehicle by gently trying to pull forward.

Step Two: Service Brake Test

All Vehicles:

Release parking brake(s); pull forward at 5 mph, apply service brake. Check brakes work properly & vehicle does not pull to side.

Step Three: Hydraulic Brake Check:

(if vehicle so equipped; if not go to Air Brakes Step3)

1. Pump brake pedal 3 times; hold down for 5 seconds. Brake pedal should not move

2. If equipped with hydraulic brake reserve, with the key off, depress brake pedal; listen for sound of reserve system electric motor



Step Three: Air Brake Check- ***Three Parts***

Note: wheels should be chocked if on incline

I. Air Leak Check:

Run engine; build air pressure to 100 to 125 psi (operational level).

Shut ENGINE OFF/ turn IGNITION KEY ON

Release TPV & Parking brakes (push knobs in)

Apply foot brake/ hold for one (1) minute.

Check air gauge; cannot drop more than:

Single Vehicle: 3 pounds in 1 minute.

Combination Vehicle: 4 pounds in 1 minute.

II. Low Air Alarm Check:

ENGINE = OFF IGNITION KEY = ON

Air pressure still in operational range

Describe what you are doing and what the expected results will be:

Pump brake pedal to reduce air pressure:

Low Air Warning Alarm should come on before air pressure drops below 60 psi +/-.

III. Tractor Protection Valve / Spring Brake Check:

Continue to fan off the air pressure:

TPV & Parking Brake Valve should close (pop out) when pressure drops between 20 - 45 psi.

On some combination and single vehicle types, parking brake valve should close (pop out).

13.4 SAMPLE PRE-TRIP INSPECTION FORM

ABC TRUCK & BUS COMPANY [SAMPLE PRE-TRIP INSPECTION FORM] DRIVER # _____ VEHICLE # _____
 DATE _____ TIME _____ TRIP NUMBER _____ TRAILER # _____

FRONT LIGHTS	
(Turn L - R - 4way - HI/Low beam, Clearance)	
ENGINE COMPARTMENT	
Oil Level	
Coolant Level	
Power Steering Fluid / Belt	
Water Pump / Belt	
Alternator / Belt	
Air Compressor/ Belt	
Leaks and Hoses	
ENGINE START	
Safety Belt	
Emergency Gear	
Safe Start	
Temperature Gauge	
Oil Pressure Gauge	
Ammeter / Voltmeter Gauge	
Air Gauge	
Dash Light Indicators	
Horn(s)	
Heater / Defroster	
Windshield and Mirrors	
Wipers and Washer	
FRONT AXLE	
Steering	
Steering Box and Hoses	
Steering Linkage	
Front Suspension	
Springs and Shocks	
Spring Mounts	
U-Bolts	
Brakes	
Slack Adjustor & Pushrod	
Brake Chamber	
Brake Hoses or Lines	
Drum & Linings or Rotor & Disks	
Wheels/Tires	
Tires	
Rims	
Lug Nuts	
Hub Oil Seal	
BRAKE TEST	
Truck / Bus Parking	
Trailer Parking	
Service Brake / ABS	
Air/Hydraulic Brake Checks	
Remarks:	

DRIVER / FUEL AREA /UNDER VEHICLE	
Door and Mirror	
Fuel Tank, Cap, Leaks	
Catwalk & Steps	
Truck side lights / Reflectors / Refl. Tape	
Exhaust System	
Drive Shaft	
Frame	
FIFTH WHEEL COUPLING	
Tractor	Air/Electric Lines & connectors
Mounting Bolts	
Locking jaws or Lever	
Release Arm	
Platform	
Skid Plate	
Sliding 5 th Wheel	
Trailer	Air/Electric Lines & connectors
Kingpin	
Apron	
Gap	
FRONT & SIDE OF TRAILER	
Front of Trailer	
Header Board or Bulkhead	
Front Lights & Reflectors	
Side of Trailer	
Landing Gear	
Doors / Ties / Lifts	
Frame and Tandem Release Arm	
Lights & Reflectors/Reflective Tape	
REAR AXLE Truck or Tractor	
Rear Wheels / Tires	
Tires	
Rims	
Lug Nuts	
Axle Seal	
Spacers or Budd Spacing	
Rear Suspension	
Springs & Shocks/Air Bags	
U- Bolts	
Spring / Air Mounts & Torque Arm	
Rear of Vehicle/Brakes	
Slack Adjustor & Pushrod	
Brake Chamber	
Brake hoses or lines	
Drum & Linings or Rotor & Disk	
CLASS B/C VEHICLE REAR	
Doors & Ties & Lifts	
Mud Flaps	
Lights, Reflectors & Reflective Tape	
turn L- R - 4 way - Tail light, brake light, clearance light	

SCHOOL BUS ONLY	
STUDENT LIGHTS	
Student Lights (front, back)	
STUDENT SAFETY ITEMS	
Stop Arm & Safety Arm	
Student Mirrors	
Emergency Kit and Body Fluid Kit	
ALL PASSENGER VEHICLES	
Passenger Items	
Passenger Entry and lift	
Emergency Exits	
Seating	
Baggage Compartment	
Doors secure (baggage)	
OTHER COUPLING SYSTEMS	
Truck	Air & Electric Connectors & lines
Mounting Bolts	
Rattle Hook or Ball	
Hitch Release Lever	
Safety Devices	
Trailer	Air & Electric Connectors & Lines
Tongue Storage Area	
Tongue or Drawbar	
Mounting Bolts	
Safety Devices	
Sliding Rattle	
REAR AXLE TRAILER	
Rear Wheels / Tires	
Tires	
Rims	
Lug Nuts	
Axle Seal	
Spacers or Budd Spacing	
Rear Suspension	
Springs & Shocks/Air Bags	
U- Bolts	
Spring / Air Mounts & Torque Arm	
Rear of Vehicle/Brakes	
Slack Adjustor & Pushrod	
Brake Chamber	
Brake hoses or lines	
Drum & Linings or Rotor & Disk	
NOTES FOR MECHANIC	

Condition of the Above Vehicle is Satisfactory: ___ Yes ___ No Driver's Signature _____
 Above Defects Corrected: _____ Above Defects need to be corrected for safe operation of the vehicle _____
 Mechanic's Signature _____ Date _____ Mechanic Assigned: _____

Inside back cover

Catalog # 01-970001-2

Please keep this manual
for future reference.

Drive Safely!

